



SEFERIADIS

LEAF SPRING FACTORY



CATALOGUE **2018**



SEFERIADIS
LEAF SPRING FACTORY



ABOUT US

The "SEFERIADIS Brs. S.A." was established in 1983 by three brothers.

It is a family business which turns out truck springs. It is warranted and internationally recognized company which is developed continuously. In 1999, the company made a new investment and upgrade its production, both in quality and quantity. It also produces new types of springs and runs in a building of 10000 square meters. At the same time, it trades several other types of truck parts. The building and the offices are in north - eastern Greece and there are branches in Thessaloniki

Facing the challenges of the 21st Century and dedicated to the achievement of high ends, the "SEFERIADIS Brs. S.A." does its best to remain the uncontested leader in the field of spare parts and springs.

Our plant is equipped with the latest computers controlled machines, controlled heat treatment furnaces new technology parabolic machine and eye-forming machines

All the staff of SEFERIADIS Company try continuously to seek new ideas and to acquire the latest technology. The technology procedure of the producing is executed regarding to the European standards and to the requirements of the customers.

All phases of the manufacturing process and the finished products are subjected to quality control procedures.

The company aims at quick delivery time and good quality or the servicing of our customers.

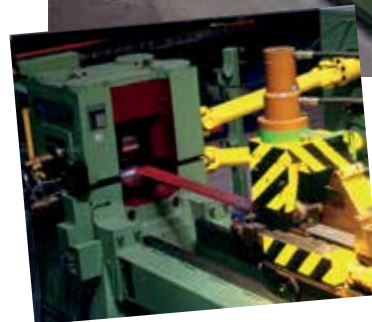



CONTENTS

MERCEDES	4-18
MAN	19-30
VOLVO	31-37
SCANIA	38-41
DAF	42-43
IVECO	44-46
RENAULT	47-49
ASTRA	50-51
BPW	52-65
SCHMITZ	66-68
KASSBOHRER	69-70
ROR	71-73
TRAILER	74-75
SAF	76-78
FREUHAUF	79
	80
FREIGHTLINER	81-82

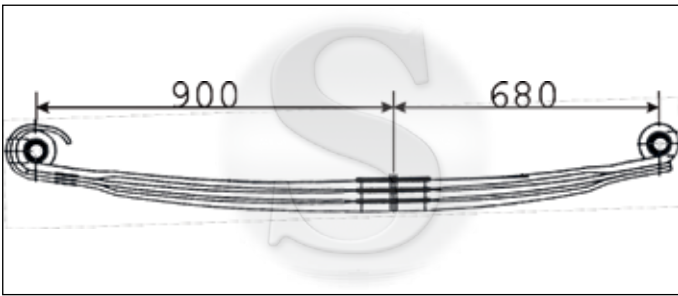

CODE	TYPE	LEAVES	MATERIAL SIZE	LENGTH		EYE	
				F	R	F	R
5063010	ACTROS	3		900	680		
5063011			90x23				
5063012			90x25				
5063013			90x25				

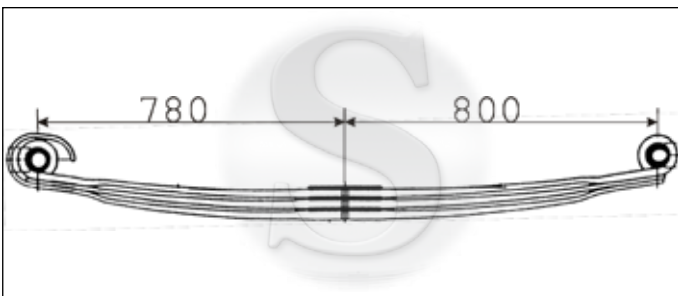

CODE	TYPE	LEAVES	MATERIAL SIZE	LENGTH		EYE	
				F	R	F	R
5063410	ACTROS	3		780	800		
5063411			90x23				
5063412			90x25				
5063413			90x25				

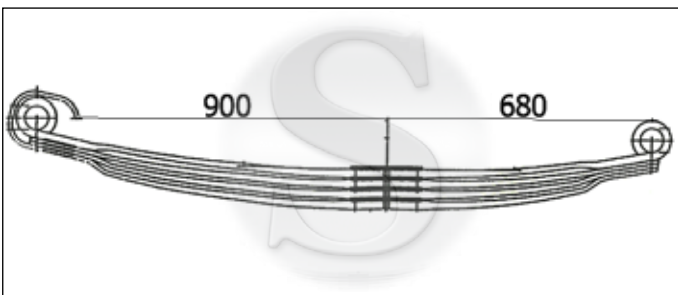

CODE	TYPE	LEAVES	MATERIAL SIZE	LENGTH		EYE	
				F	R	F	R
5063110	ACTROS	4		900	680		
5063111			90x23				
5063112			90x23				
5063113			90x23				
5063114			90x23				

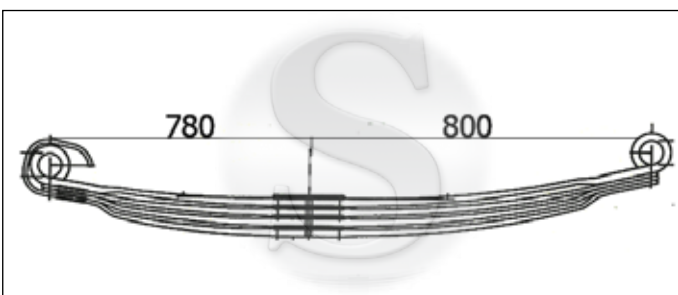

CODE	TYPE	LEAVES	MATERIAL SIZE	LENGTH		EYE	
				F	R	F	R
5063510	ACTROS	4		780	800		
5063511			90x23				
5063512			90x23				
5063513			90x23				
5063514			90x23				

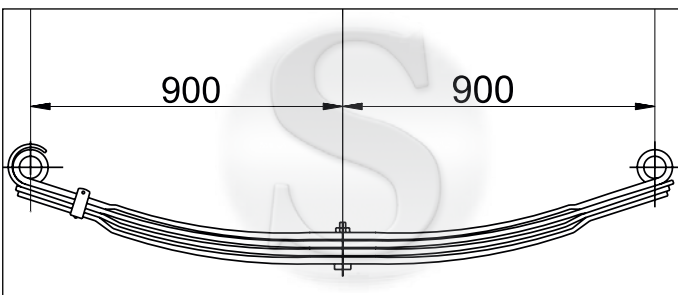

CODE	TYPE	LEAVES	MATERIAL SIZE	LENGTH		EYE	
				F	R	F	R
5063810	ACTROS	4		900	900		
5063811			90x20				
5063812			90x20				
5063813			90x20				
5063814			90x20				

Any reference to manufacture' s numbers are for the comparison purpose only. Alle Hersteller-Referenzen dien nur zu Vergleichswecken. Les references constructeur servent uniquement atitre d' indetification

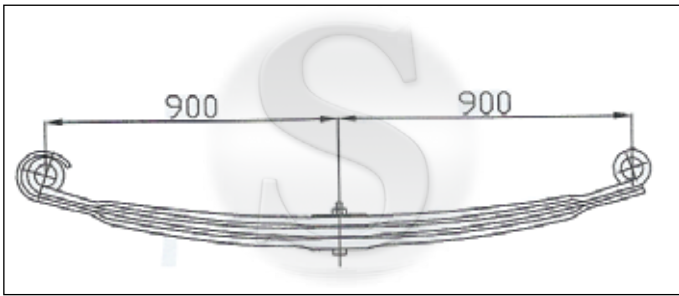

CODE	TYPE	LEAVES	MATERIAL SIZE	LENGTH		EYE	
				F	R	F	R
5063610	ACTROS	3		900 - 900			
5063611			90x25				
5063612			90x26				
5063613			90x26				

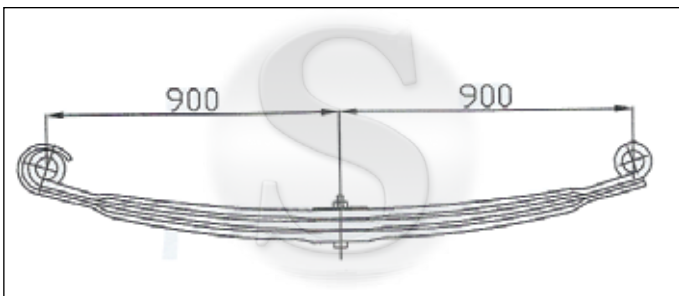

CODE	TYPE	LEAVES	MATERIAL SIZE	LENGTH		EYE	
				F	R	F	R
5063710	ACTROS	3		900 - 680			
5063711			90x22				
5063712			90x25				
5063713			90x25				

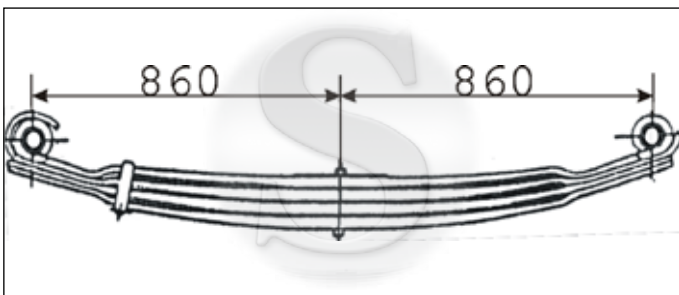

CODE	TYPE	LEAVES	MATERIAL SIZE	LENGTH		EYE	
				F	R	F	R
5062610	ACTROS	4		860 - 860			
5062611			80x22				
5062612			80x22				
5062613			80x22				
5062614			80x22				

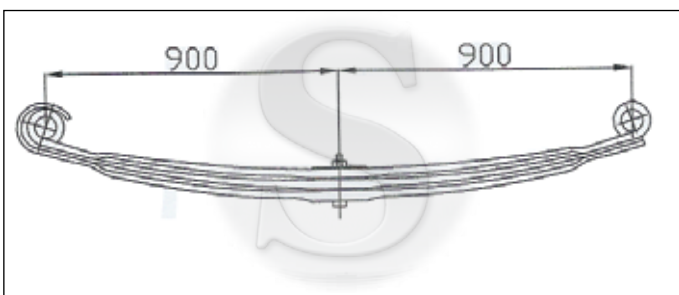

CODE	TYPE	LEAVES	MATERIAL SIZE	LENGTH		EYE	
				F	R	F	R
5065610	ACTROS	3		900 - 900			
5065611			90x22				
5065612			90x24				
5065613			90x24				

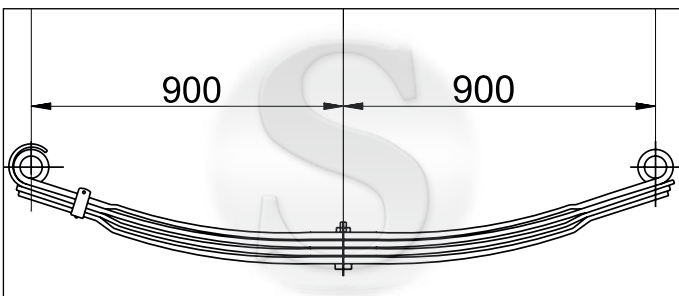

CODE	TYPE	LEAVES	MATERIAL SIZE	LENGTH		EYE	
				F	R	F	R
5065910	ACTROS	4		900 - 900			
5065911			90x23				
5065912			90x23				
5065913			90x23				
5065914			90x23				

Any reference to manufacture' s numbers are for the comparison purpose only. Alle Hersteller-Referenzen dien nur zu Vergleichswecken. Les references constructeur servent uniquement atitre d' indetification

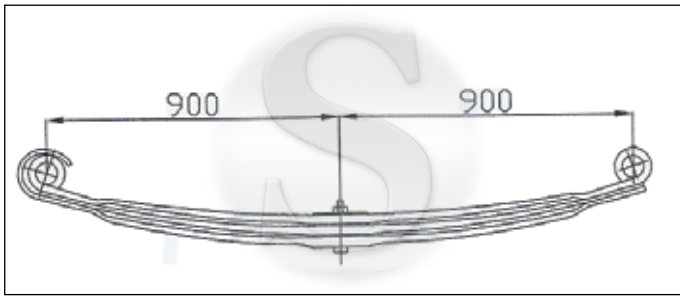

CODE	TYPE	LEAVES	MATERIAL SIZE	LENGTH		EYE	
				F	R	F	R
5066610		3		900 - 900			
5066611			90x28				
5066612			90x29				
5066613			90x29				

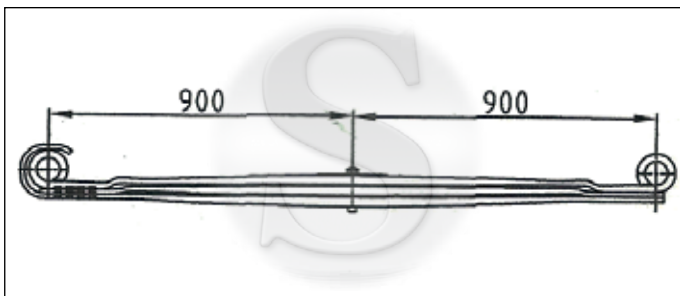

CODE	TYPE	LEAVES	MATERIAL SIZE	LENGTH		EYE	
				F	R	F	R
5067400		3		900 - 900			
5067401			90x24				
5067402			90x25				
5067403			90x25				

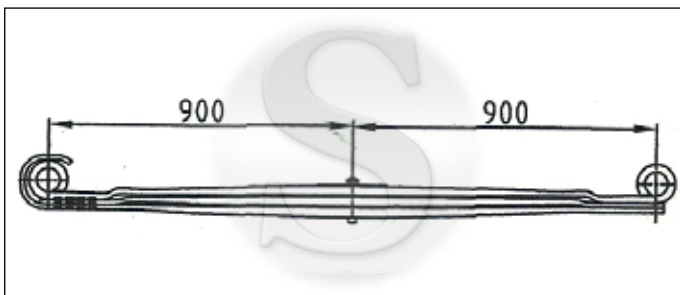

CODE	TYPE	LEAVES	MATERIAL SIZE	LENGTH		EYE	
				F	R	F	R
5067410		3		900 - 900			
5067411			90x22				
5067412			90x25				
5067413			90x25				

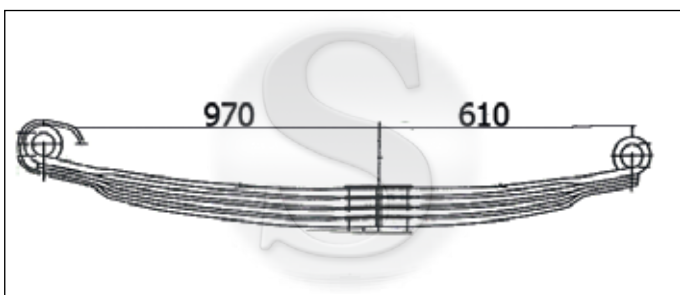

CODE	TYPE	LEAVES	MATERIAL SIZE	LENGTH		EYE	
				F	R	F	R
5066910		4		970 - 610			
5066911			90x22				
5066912			90x22				
5066913			90x22				
5066914			90x22				



CODE	TYPE	LEAVES	MATERIAL SIZE	LENGTH		EYE	
				F	R	F	R
5066500		3		970 - 830			
5066501			90x28				
5066502			90x28				
5066503			90x28				

Any reference to manufacture' s numbers are for the comparison purpose only. Alle Hersteller-Referenzen dien nur zu Vergleichswecken. Les references constructeur servent uniquement atitre d' indetification

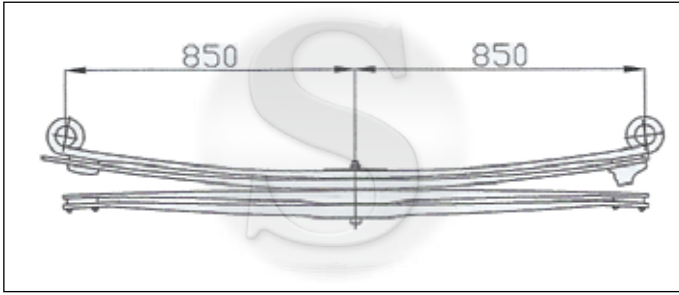

CODE	TYPE	LEAVES	MATERIAL SIZE	LENGTH		EYE	
				F	R	F	R
5065220	ATECO	4		850 - 850			
5065221	15-17		90x23				
5065222	15-29		90x28				
5065223			90x39				
5065224			90x39				

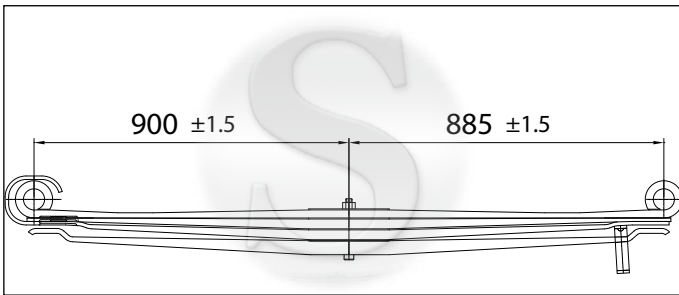

CODE	TYPE	LEAVES	MATERIAL SIZE	LENGTH		EYE	
				F	R	F	R
5065720		4		900 - 885			
5065721			100x23				
5065722			100x28				
5065723			100x28				
5065724			100x40				

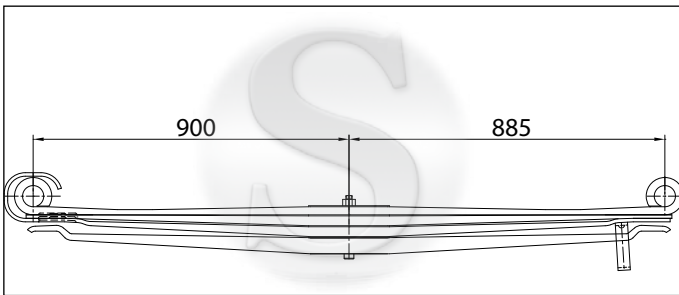

CODE	TYPE	LEAVES	MATERIAL SIZE	LENGTH		EYE	
				F	R	F	R
5065820		4		900 - 885			
5065821			100x23				
5065822			100x28				
5065823			100x28				
5065824			100x46				

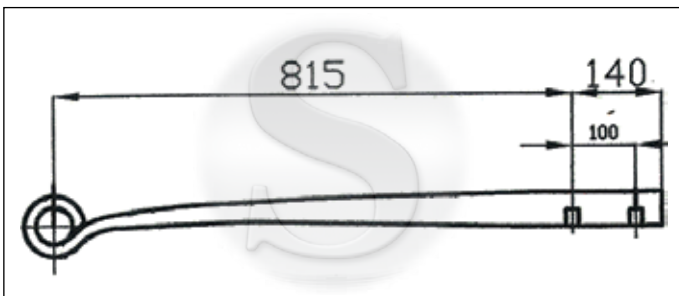

CODE	TYPE	LEAVES	MATERIAL SIZE	LENGTH		EYE	
				F	R	F	R
5067320	ATECO	3	75x53	815 - 140			

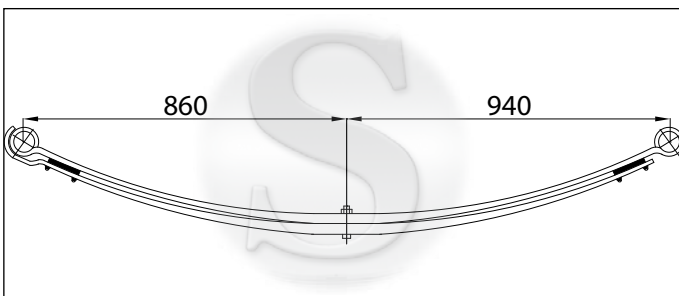

CODE	TYPE	LEAVES	MATERIAL SIZE	LENGTH		EYE	
				F	R	F	R
5064960	ATECO	4		860 - 940			
5064961			80x27				
5064962			80x28				

Any reference to manufacture's numbers are for the comparison purpose only. Alle Hersteller-Referenzen dien nur zu Vergleichszwecken. Les references constructeur servent uniquement atitre d' indetification

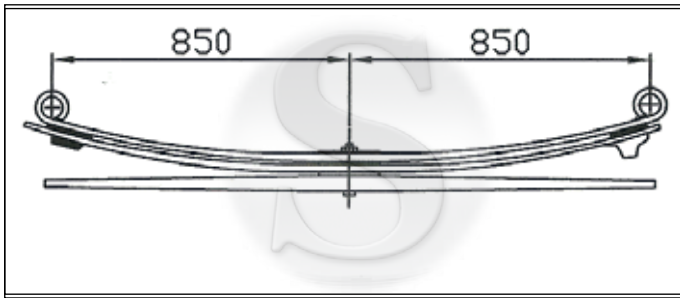

CODE	TYPE	LEAVES	MATERIAL SIZE	LENGTH		EYE	
				F	R	F	R
5063330		3		850 - 850			
5063331			80x23				
5063332			80x24				
5063333			80x45				

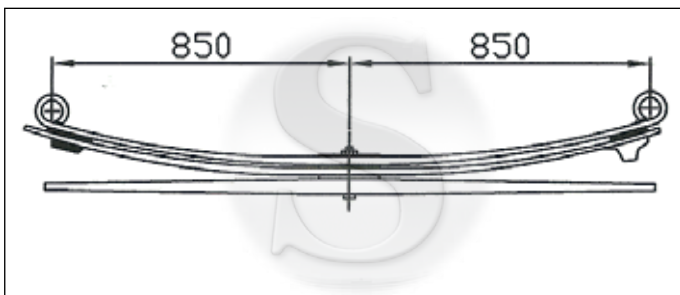

CODE	TYPE	LEAVES	MATERIAL SIZE	LENGTH		EYE	
				F	R	F	R
5063230		3		850 - 850			
5063231			80x23				
5063232			80x26				
5063233			80x47				

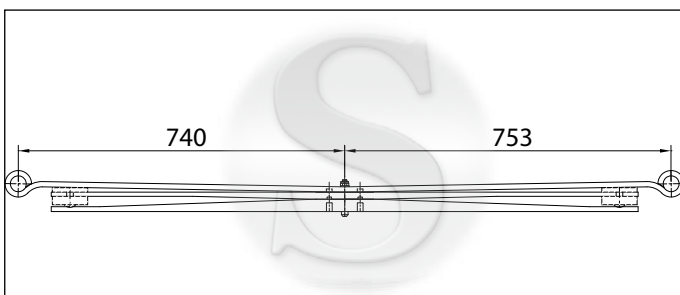

CODE	TYPE	LEAVES	MATERIAL SIZE	LENGTH		EYE	
				F	R	F	R
5064060	SPRINTER	3		745 - 745			
5064061	410-416		70x12				
5064062	WV		70x15				
5064063	LT-46		70x28				

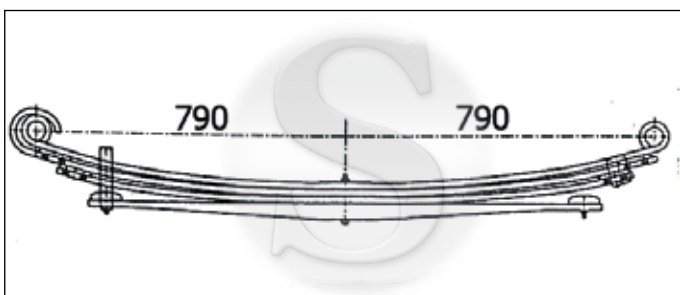

CODE	TYPE	LEAVES	MATERIAL SIZE	LENGTH		EYE	
				F	R	F	R
5067210	709	4		790 - 790			
5067211			70x14				
5067212			70x14				
5067213			70x14				
5067214			70x36				

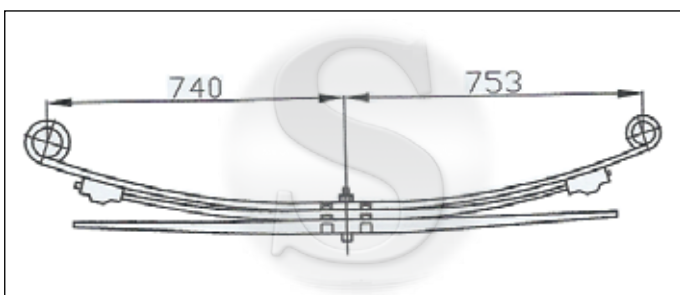

CODE	TYPE	LEAVES	MATERIAL SIZE	LENGTH		EYE	
				F	R	F	R
5064050	SPRINTER	3		740 - 753			
5064051			70x15				
5064052			70x18				
5064053			70x28				

Any reference to manufacture' s numbers are for the comparison purpose only. Alle Hersteller-Referenzen dien nur zu Vergleichswecken. Les references constructeur servent uniquement atitre d' indetification

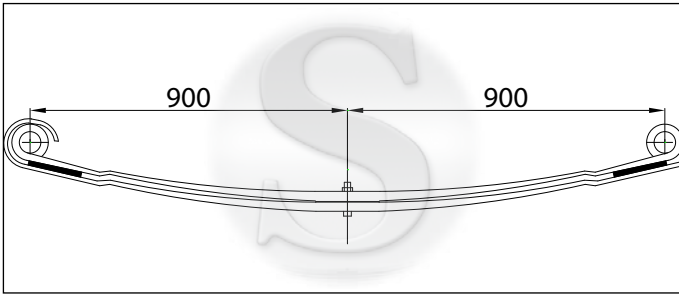

CODE	TYPE	LEA- VES	MATERIAL SIZE	LENGTH		EYE	
				F	R	F	R
5067010		2		900 - 900			
5067011			90x27				
5067012			90x27				

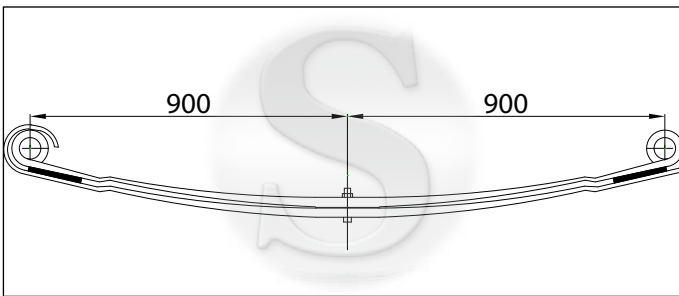

CODE	TYPE	LEA- VES	MATERIAL SIZE	LENGTH		EYE	
				F	R	F	R
5067110		2		900 - 900			
5067111			90x28				
5067112			90x28				

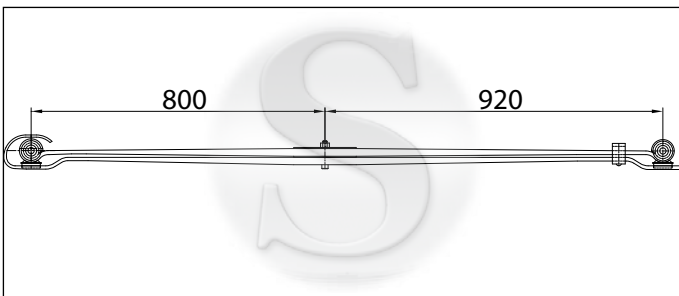

CODE	TYPE	LEA- VES	MATERIAL SIZE	LENGTH		EYE	
				F	R	F	R
5066310		2		800 - 920			
5066311			80x21				
5066312			80x21				

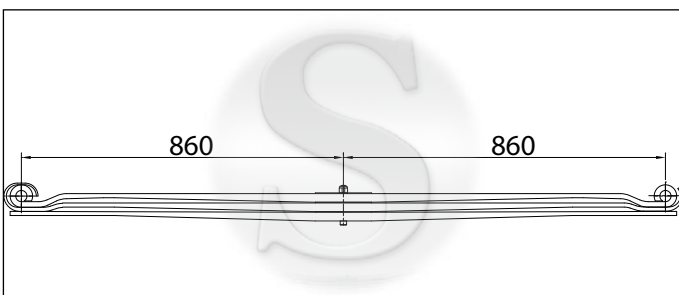

CODE	TYPE	LEA- VES	MATERIAL SIZE	LENGTH		EYE	
				F	R	F	R
5061010	1420/22	3		860 - 860			
5061011	1617/20		80x23				
5061012	1622/25		80x23				
5061013	2220		80x23				

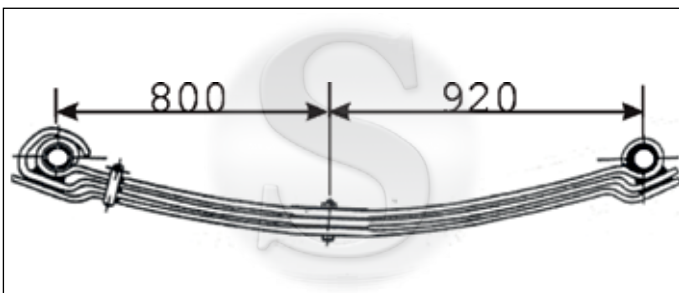

CODE	TYPE	LEA- VES	MATERIAL SIZE	LENGTH		EYE	
				F	R	F	R
5062110	1114	3		800 - 920			
5062111	1117		80x18				
5062112	1120		80x18				
5062113	814		80x18				
	817						
	914						

Any reference to manufacture's numbers are for the comparison purpose only. Alle Hersteller-Referenzen dien nur zu Vergleichswecken. Les references constructeur servent uniquement atitre d' indetification

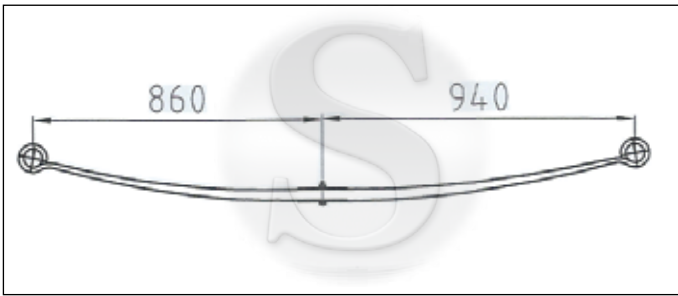

CODE	TYPE	LEAVES	MATERIAL SIZE	LENGTH		EYE	
				F	R	F	R
5064920	ATECO	1	80x30	860 - 940			

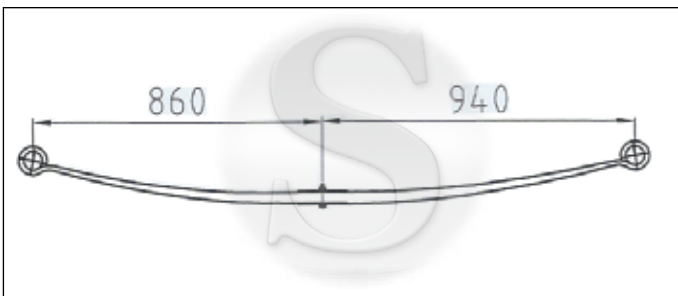

CODE	TYPE	LEAVES	MATERIAL SIZE	LENGTH		EYE	
				F	R	F	R
5064910	ATECO	1	80x29	860 - 940			

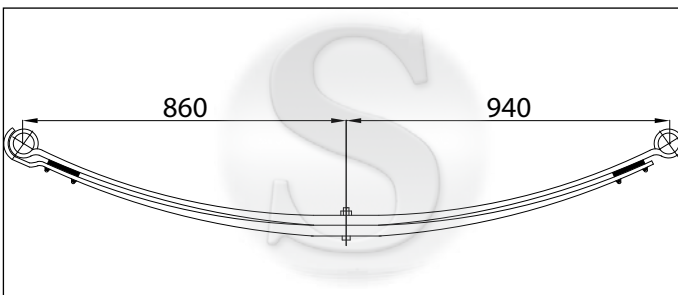

CODE	TYPE	LEAVES	MATERIAL SIZE	LENGTH		EYE	
				F	R	F	R
5064930	ATECO	2		860 - 940			
5064931			80x24				
5064932			80x26				

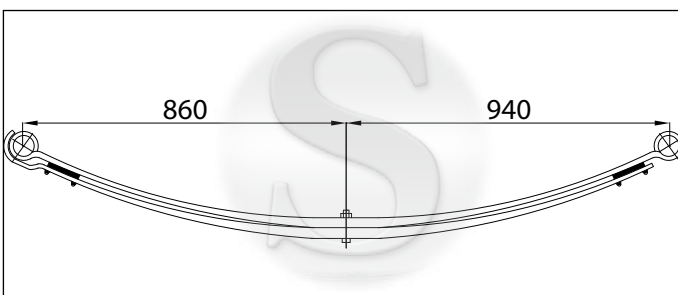

CODE	TYPE	LEAVES	MATERIAL SIZE	LENGTH		EYE	
				F	R	F	R
5064940	ATECO	2		860 - 940			
5064941			80x25				
5064942			80x27				

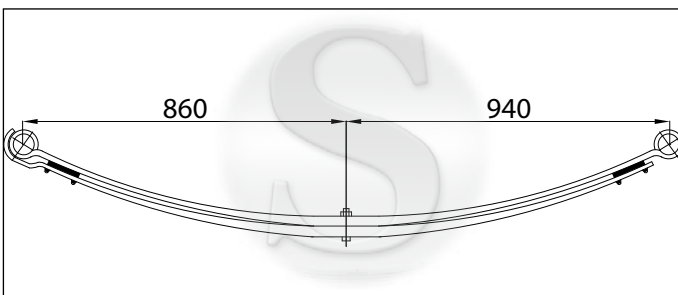

CODE	TYPE	LEAVES	MATERIAL SIZE	LENGTH		EYE	
				F	R	F	R
5064950	ATECO	2		860 - 940			
5064951			80x27				
5064952			80x29				

Any reference to manufacture' s numbers are for the comparison purpose only. Alle Hersteller-Referenzen dien nur zu Vergleichswecken. Les references constructeur servent uniquement atitre d' indetification

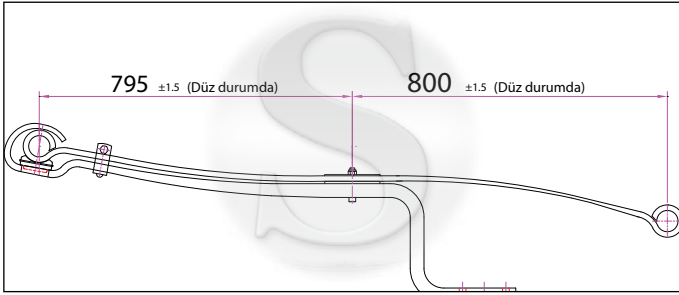

CODE	TYPE	LEA- VES	MATERIAL SIZE	LENGTH		EYE	
				F	R	F	R
5062510	817L	2		795 - 800			
5062511	817LS		80x14				
5062512			80x35				

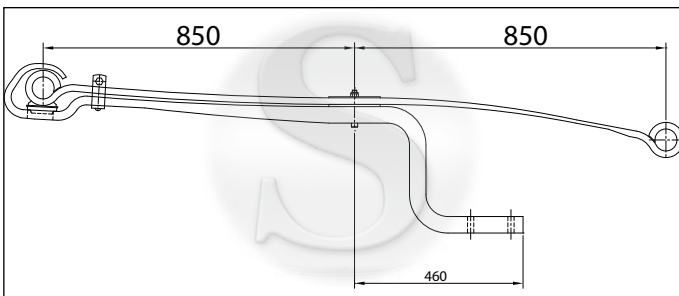

CODE	TYPE	LEA- VES	MATERIAL SIZE	LENGTH		EYE	
				F	R	F	R
5062410	1114/17	2		850 - 850			
5062411	1120		80x18				
5062412	1314/17		80x45				
	1320						

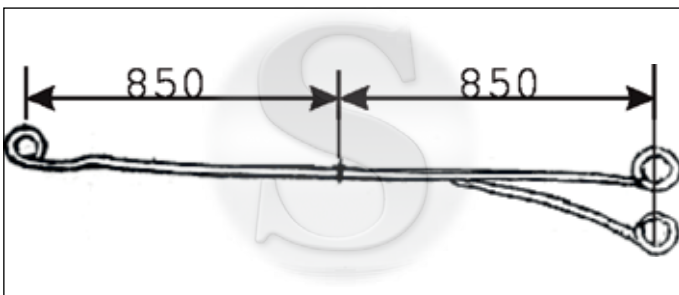

CODE	TYPE	LEA- VES	MATERIAL SIZE	LENGTH		EYE	
				F	R	F	R
5062431			80x18	850 - 850			

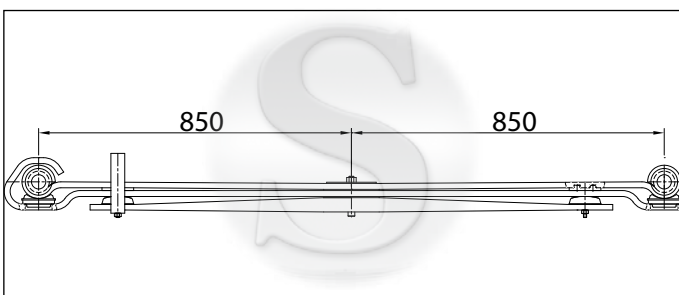

CODE	TYPE	LEA- VES	MATERIAL SIZE	LENGTH		EYE	
				F	R	F	R
5060710		3		790 - 790			
5060711			80x15				
5060712			80x15				
5060713			80x36				

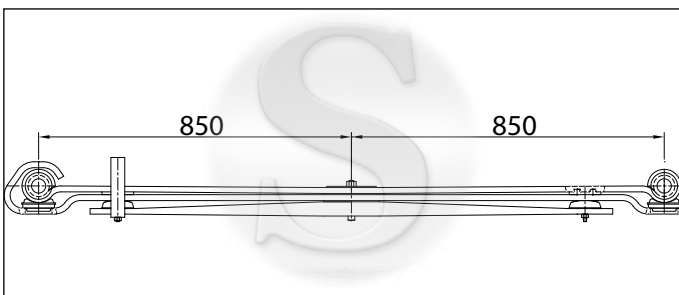

CODE	TYPE	LEA- VES	MATERIAL SIZE	LENGTH		EYE	
				F	R	F	R
5060810		3		850 - 850			
5060811			80x18				
5060812			80x18				
5060813			80x46				

Any reference to manufacture' s numbers are for the comparison purpose only. Alle Hersteller-Referenzen dien nur zu Vergleichswecken. Les references constructeur servent uniquement atitre d' indetification

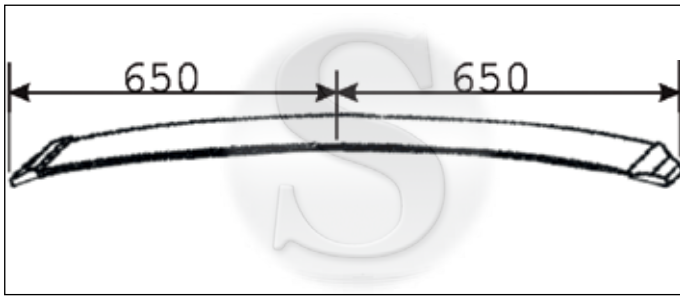

CODE	TYPE	LEA- VES	MATERIAL SIZE	LENGTH		EYE	
				F	R	F	R
5064320	212-D	1	110x15	650	650		
	208						

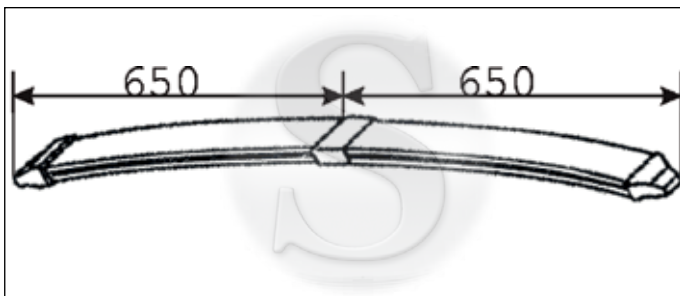

CODE	TYPE	LEA- VES	MATERIAL SIZE	LENGTH		EYE	
				F	R	F	R
5063930	312-D	2	110x13	650	650		

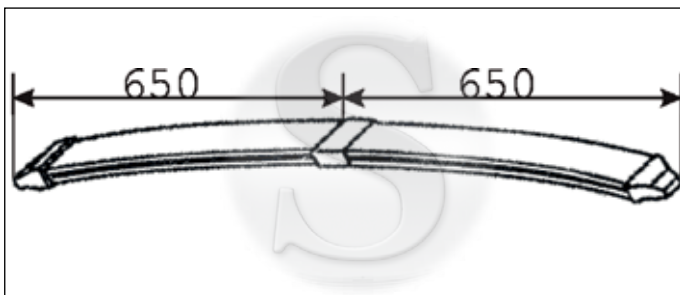

CODE	TYPE	LEA- VES	MATERIAL SIZE	LENGTH		EYE	
				F	R	F	R
5064120	308-D	2	100x13	650	650		

CODE	TYPE	LEA- VES	MATERIAL SIZE	LENGTH		EYE	
				F	R	F	R
5064720		1	103x25	807			

CODE	TYPE	LEA- VES	MATERIAL SIZE	LENGTH		EYE	
				F	R	F	R
5064820		1	103x25	850			

Any reference to manufacture' s numbers are for the comparison purpose only. Alle Hersteller-Referenzen dien nur zu Vergleichswecken. Les references constructeur servent uniquement atitre d' indetification

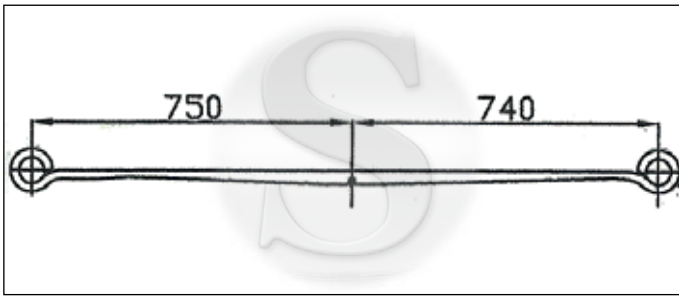

CODE	TYPE	LEAVES	MATERIAL SIZE	LENGTH		EYE	
				F	R	F	R
5064230	SPRINTER	1	70x25	750	740		
	906						
	2500						
	313 CDI						
	VW						

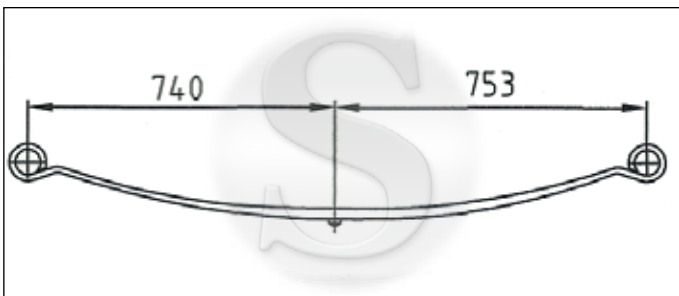

CODE	TYPE	LEAVES	MATERIAL SIZE	LENGTH		EYE	
				F	R	F	R
5064250		1	70x26	740	753		

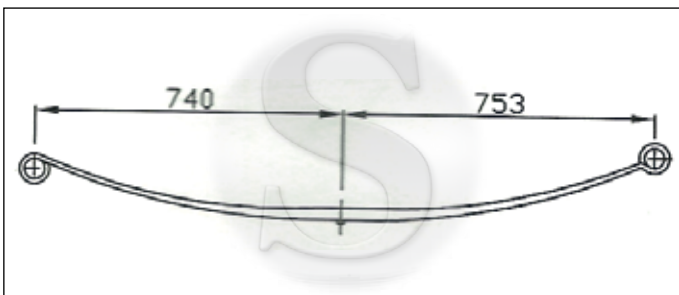

CODE	TYPE	LEAVES	MATERIAL SIZE	LENGTH		EYE	
				F	R	F	R
5064260	SPRINTER	1	70x25	740	753		
	903						

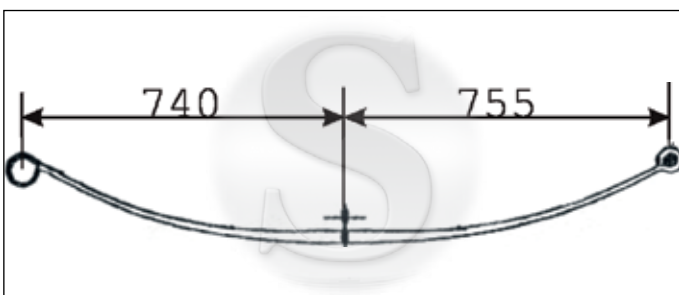

CODE	TYPE	LEAVES	MATERIAL SIZE	LENGTH		EYE	
				F	R	F	R
5064220	212	1	70x24	740	755		
	295-32T						

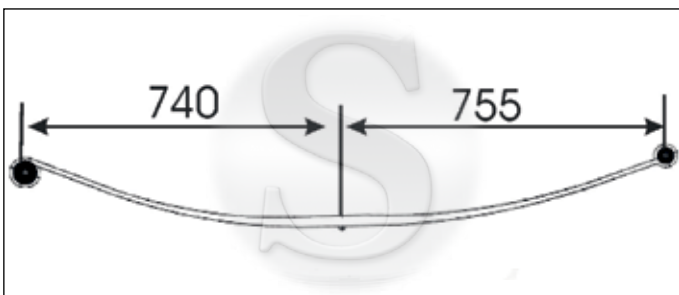

CODE	TYPE	LEAVES	MATERIAL SIZE	LENGTH		EYE	
				F	R	F	R
5066710	SPRINTER	1	70x25	740	755		
	903						

Any reference to manufacture' s numbers are for the comparison purpose only. Alle Hersteller-Referenzen dien nur zu Vergleichswecken. Les references constructeur servent uniquement atitre d' indetification

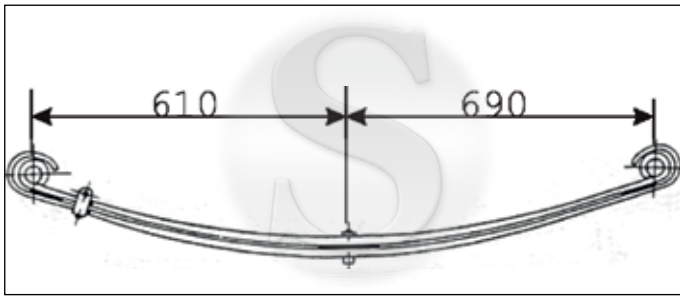

CODE	TYPE	LEAVES	MATERIAL SIZE	LENGTH		EYE	
				F	R	F	R
5060000	207	2	60x14	610	690		
	208						
	209						
	307						
	308						
	309						

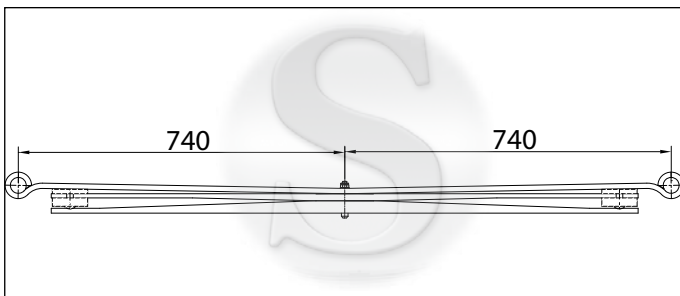

CODE	TYPE	LEAVES	MATERIAL SIZE	LENGTH		EYE	
				F	R	F	R
5064020	SPRINTER	2/1		740	753		
5064021	904		70x12				
5064022			70x15,5				
5064023			70x28				

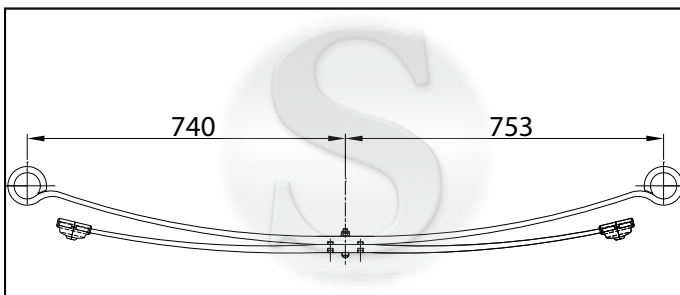

CODE	TYPE	LEAVES	MATERIAL SIZE	LENGTH		EYE	
				F	R	F	R
5065510	SPRINTER	2		740	755		
5065511	903		70x18,5				
5065512			70x20				

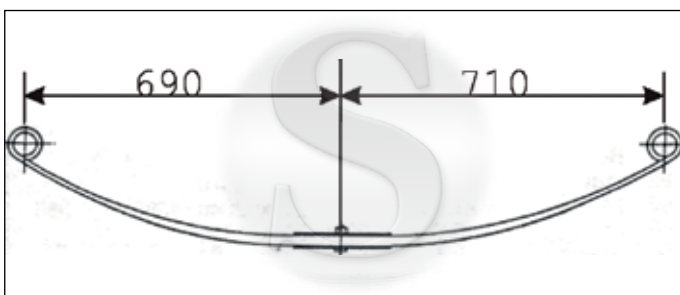

CODE	TYPE	LEAVES	MATERIAL SIZE	LENGTH		EYE	
				F	R	F	R
5063310	MB	1	70x21	690	710		
	100						

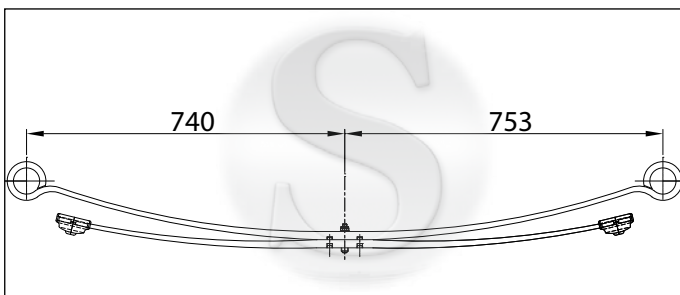

CODE	TYPE	LEAVES	MATERIAL SIZE	LENGTH		EYE	
				F	R	F	R
5067140		2		740	753		
5067141			70x19				
5067142			70x19				

Any reference to manufacture' s numbers are for the comparison purpose only. Alle Hersteller-Referenzen dien nur zu Vergleichswecken. Les references constructeur servent uniquement atitre d' indetification

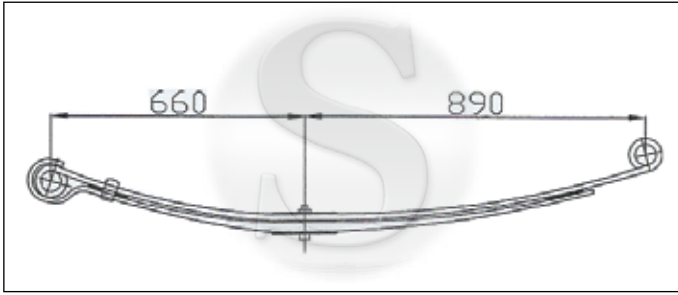

CODE	TYPE	LEAVES	MATERIAL SIZE	LENGTH		EYE	
				F	R	F	R
5064210		2		660 - 890			
5064211			70x21				
5064212			70x21				

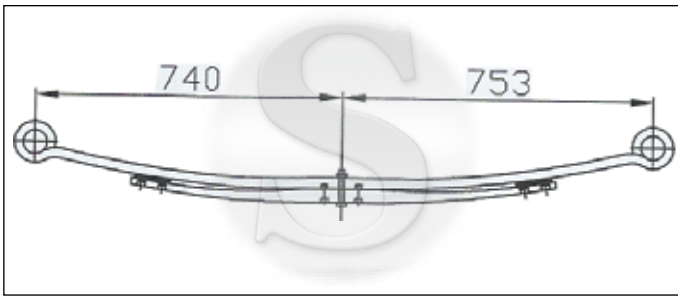

CODE	TYPE	LEAVES	MATERIAL SIZE	LENGTH		EYE	
				F	R	F	R
5067520		2		740 - 753			
5067521			70x19				
5067522			70x28				

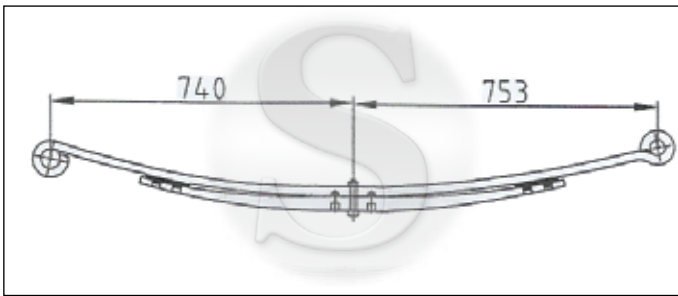

CODE	TYPE	LEAVES	MATERIAL SIZE	LENGTH		EYE	
				F	R	F	R
5064240		2		740 - 753			
5064241			70x18				
5064242			70x28				

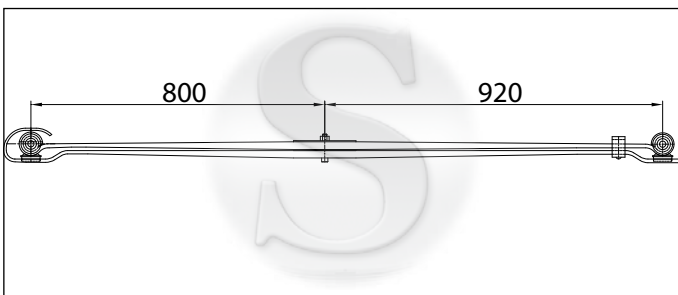

CODE	TYPE	LEAVES	MATERIAL SIZE	LENGTH		EYE	
				F	R	F	R
5066110		2		800 - 920			
5066111			80x20				
5066112			80x20				

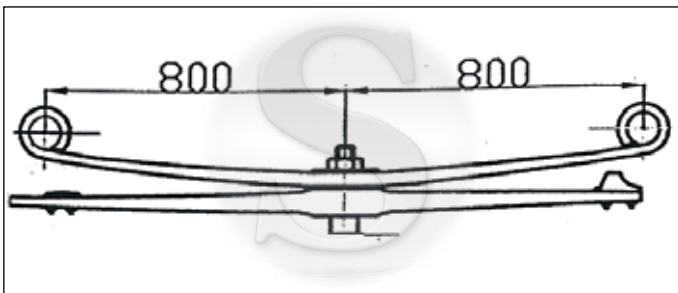

CODE	TYPE	LEAVES	MATERIAL SIZE	LENGTH		EYE	
				F	R	F	R
5067200	ATECO	2		800 - 800			
5067201			80x25				
5067202			80x38				

Any reference to manufacture' s numbers are for the comparison purpose only. Alle Hersteller-Referenzen dien nur zu Vergleichswecken. Les references constructeur servent uniquement atitre d' indetification



CODE	TYPE	LEA- VES	MATERIAL SIZE	LENGTH		EYE	
				F	R	F	R

5064040

PLASTIC

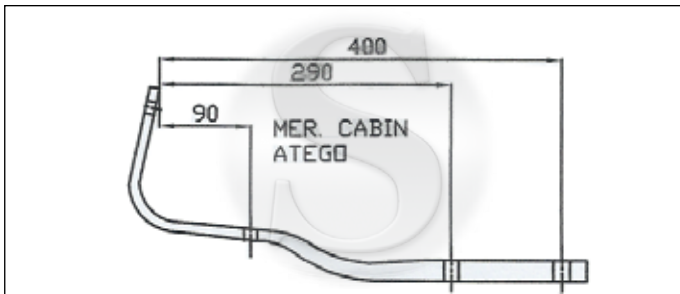

CODE	TYPE	LEA- VES	MATERIAL SIZE	LENGTH		EYE	
				F	R	F	R

5080400

ATECO

1

60x21

MER. CABIN
ATEGO

Any reference to manufacture' s numbers are for the comparison purpose only. Alle Hersteller-Referenzen dien nur zu Vergleichswecken. Les references constructeur servent uniquement atitre d' indetification

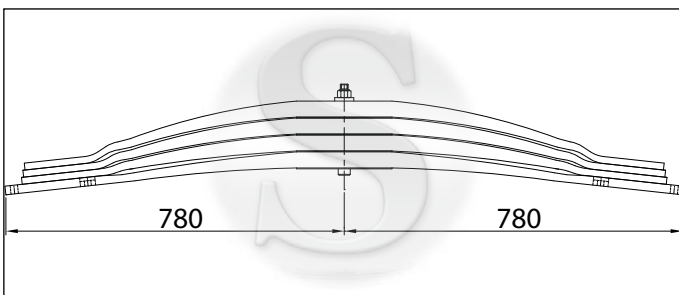
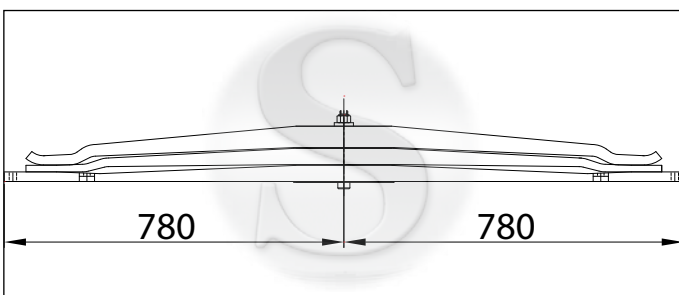
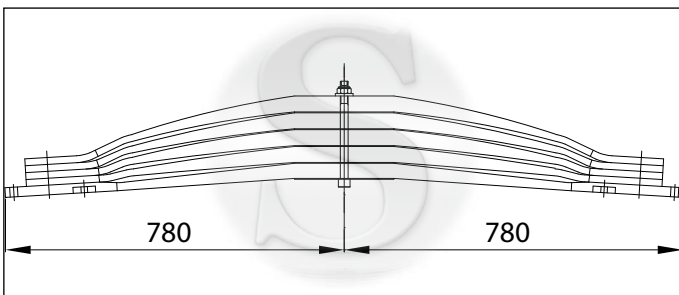
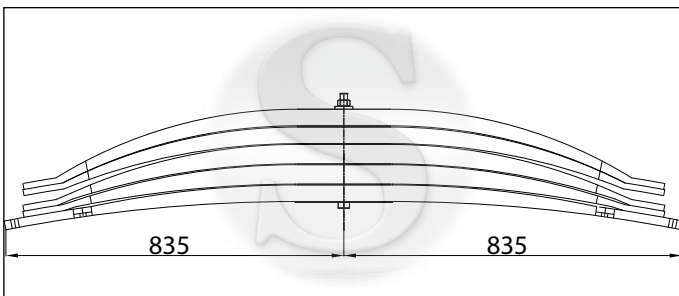
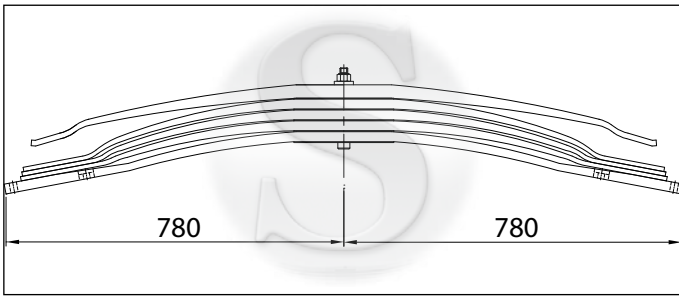

CODE	TYPE	LEAVES	MATERIAL SIZE	LENGTH		EYE	
				F	R	F	R
5063220	6x4	4/1		780	780		
5063221	8x4		100x23				
5063222			100x23				
5063223			100x23				
5063224			100x23				
5063225			100x31				

CODE	TYPE	LEAVES	MATERIAL SIZE	LENGTH		EYE	
				F	R	F	R
5066800		5		835	835		
5066801			100x41				
5066802			100x41				
5066803			100x41				
5066804			100x48				
5066805			100x48				

CODE	TYPE	LEAVES	MATERIAL SIZE	LENGTH		EYE	
				F	R	F	R
5066810		5		780	780		
5066811			100x37				
5066812			100x37				
5066813			100x37				
5066814			100x37				
5066815			100x37				

CODE	TYPE	LEAVES	MATERIAL SIZE	LENGTH		EYE	
				F	R	F	R
5063520		3		780	780		
5063521			100x37				
5063522			100x37				
5063523			100x49				

CODE	TYPE	LEAVES	MATERIAL SIZE	LENGTH		EYE	
				F	R	F	R
5063320	6x4	4		780	780		
5063321	6x8		100x33				
5063322			100x33				
5063323			100x33				
5063324			100x33				

Any reference to manufacture' s numbers are for the comparison purpose only. Alle Hersteller-Referenzen dien nur zu Vergleichswecken. Les references constructeur servent uniquement atitre d' indetification

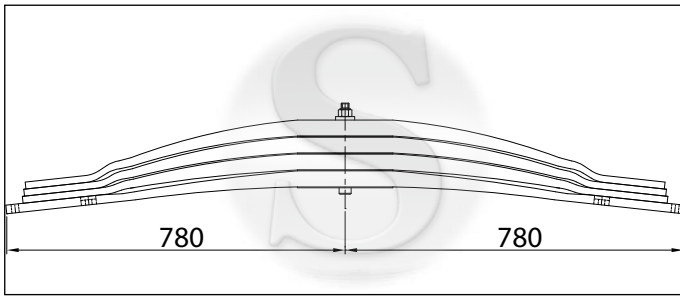

CODE	TYPE	LEAVES	MATERIAL SIZE	LENGTH		EYE	
				F	R	F	R
5063420	6x4	4		780 - 780			
5063421	8x4		100x37				
5063422			100x37				
5063423			100x37				
5063424			100x37				

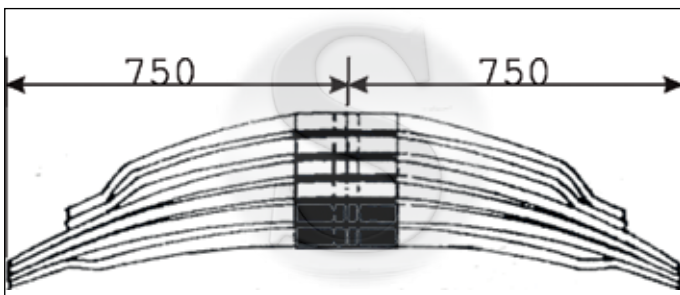

CODE	TYPE	LEAVES	MATERIAL SIZE	LENGTH		EYE	
				F	R	F	R
5062420		6		750 - 750			
5062421			93x33				
5062422			90x33				
5062423			90x33				
5062424			90x33				
5062425			90x35				
5062426			90x35				

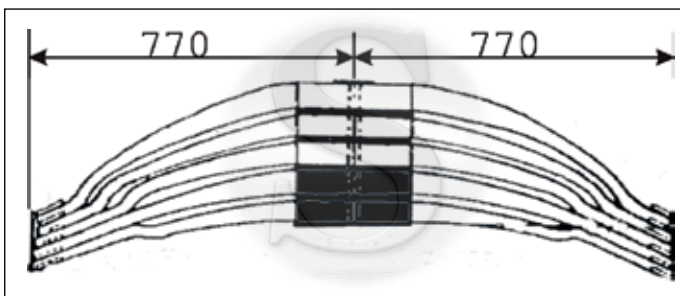

CODE	TYPE	LEAVES	MATERIAL SIZE	LENGTH		EYE	
				F	R	F	R
5062720		2		770 - 770			
5062721			94x36				
5062722			94x36				
5062723			90x36				
5062724			90x36				
5062725			90x36				

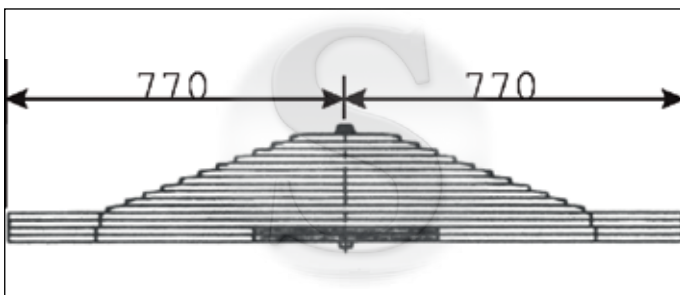

CODE	TYPE	LEAVES	MATERIAL SIZE	LENGTH		EYE	
				F	R	F	R
6060620		15	100x18	770-770			

Any reference to manufacture' s numbers are for the comparison purpose only. Alle Hersteller-Referenzen dien nur zu Vergleichswecken. Les references constructeur servent uniquement atitre d' indetification

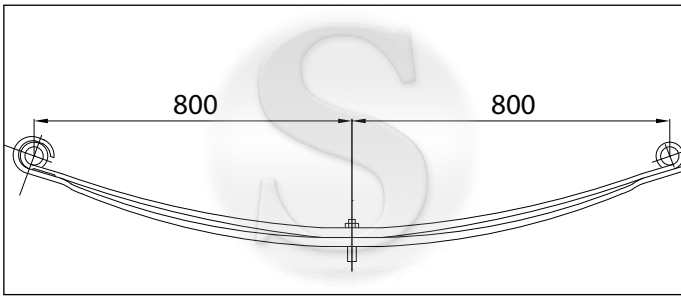

CODE	TYPE	LEA- VES	MATERIAL SIZE	LENGTH		EYE	
				F	R	F	R
5031300		2		800 - 800			
5031301			80x22				
5031302			80x22				

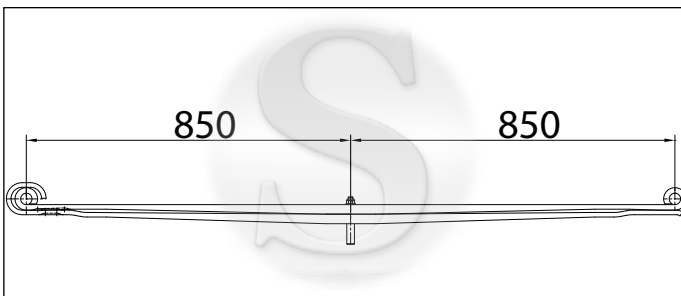

CODE	TYPE	LEA- VES	MATERIAL SIZE	LENGTH		EYE	
				F	R	F	R
5031200		2		850 - 850			
5031201			80x25				
5031202			80x25				

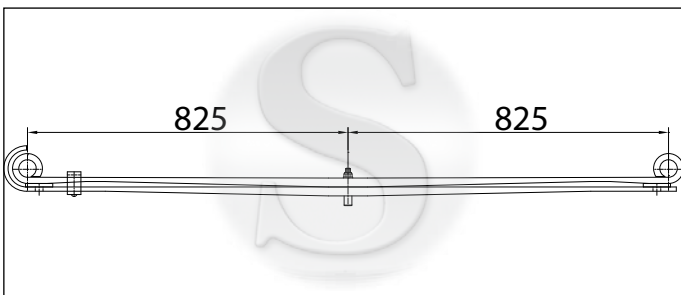

CODE	TYPE	LEA- VES	MATERIAL SIZE	LENGTH		EYE	
				F	R	F	R
5031810		2		825 - 825			
5031811			80x23				
5031812			80x23				

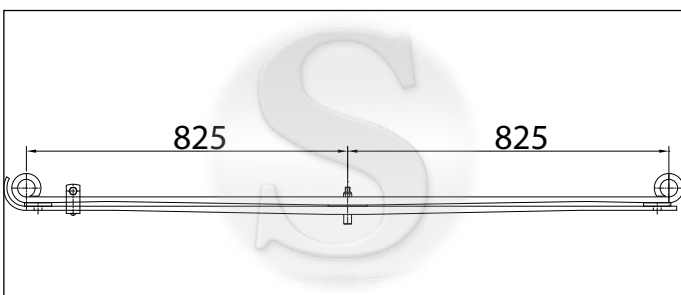

CODE	TYPE	LEA- VES	MATERIAL SIZE	LENGTH		EYE	
				F	R	F	R
5031610		2		825 - 825			
5031611	TGA		80x21				
5031612	33-412		80x21				

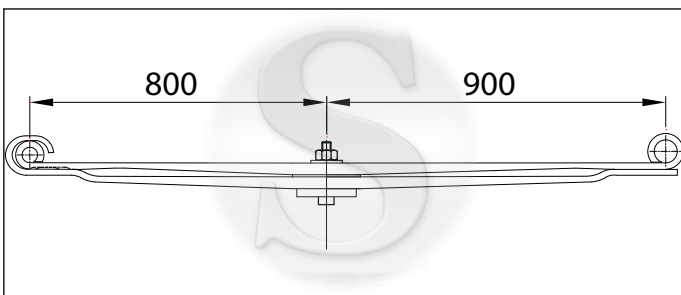

CODE	TYPE	LEA- VES	MATERIAL SIZE	LENGTH		EYE	
				F	R	F	R
5032400		2		800 - 900			
5032401			80x25				
5032402			80x25				

Any reference to manufacture' s numbers are for the comparison purpose only. Alle Hersteller-Referenzen dien nur zu Vergleichswecken. Les references constructeur servent uniquement atitre d' indetification

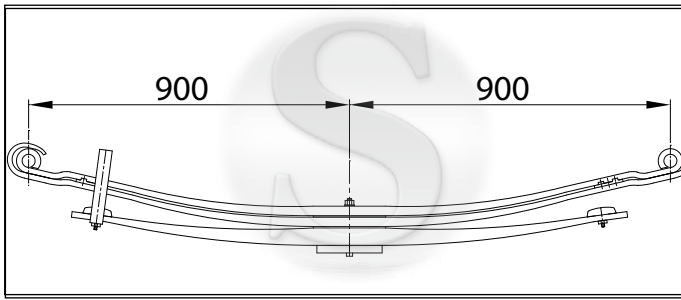

CODE	TYPE	LEA- VES	MATERIAL SIZE	LENGTH		EYE	
				F	R	F	R
5030820	TGM	2/1		900 - 900			
5030821	18T		80x28				
5030822			80x28				
5030823			80x50				

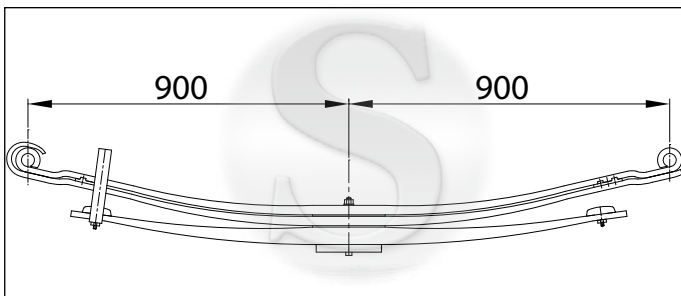

CODE	TYPE	LEA- VES	MATERIAL SIZE	LENGTH		EYE	
				F	R	F	R
5032130		2/1		900 - 900			
5032131			80x26				
5032132			80x26				
5032133			80x49				

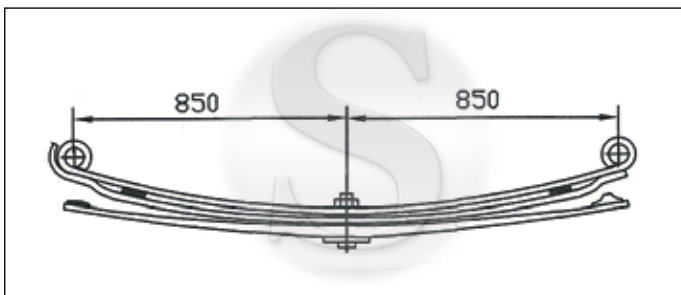

CODE	TYPE	LEA- VES	MATERIAL SIZE	LENGTH		EYE	
				F	R	F	R
5032490		2/1		850 - 850			
5032491			80x16				
5032492			80x16				
5032493			80x48				

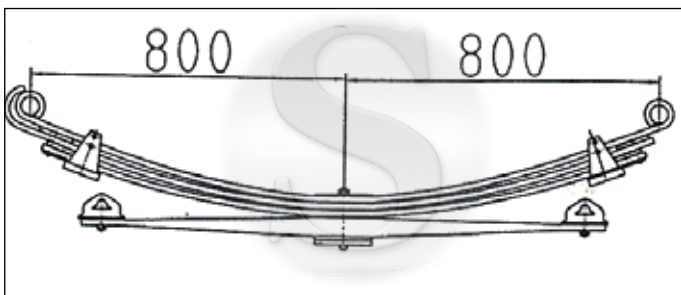

CODE	TYPE	LEA- VES	MATERIAL SIZE	LENGTH		EYE	
				F	R	F	R
5032420		3/1		800 - 800			
5032421			80x14				
5032422			80x13				
5032423			80x13				
5032424			80x45				

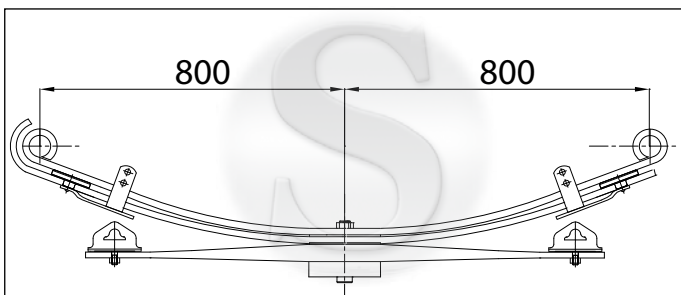

CODE	TYPE	LEA- VES	MATERIAL SIZE	LENGTH		EYE	
				F	R	F	R
5032460		2/1		800 - 800			
5032461			80x13,5				
5032462			80x13,5				
5032463			80x36				

Any reference to manufacture' s numbers are for the comparison purpose only. Alle Hersteller-Referenzen dien nur zu Vergleichswecken. Les references constructeur servent uniquement atitre d' indetification

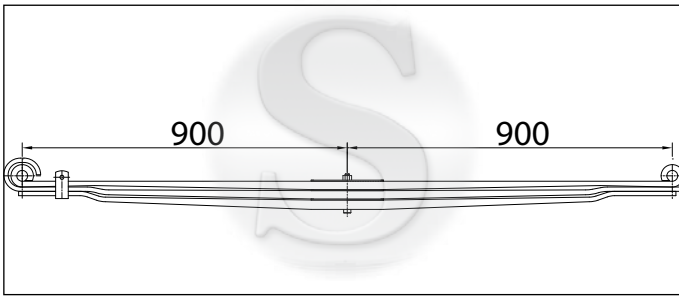

CODE	TYPE	LEA- VES	MATERIAL SIZE	LENGTH		EYE	
				F	R	F	R
5031700		3		900 - 900			
5031701			80x25				
5031702			80x25				
5031703			80x25				

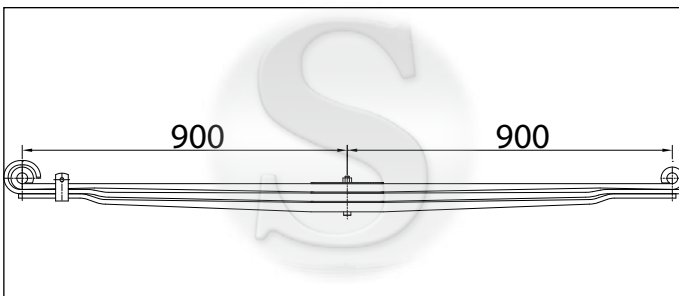

CODE	TYPE	LEA- VES	MATERIAL SIZE	LENGTH		EYE	
				F	R	F	R
5032470		3		900 - 900			
5032471			80x26				
5032472			80x26				
5032473			80x26				

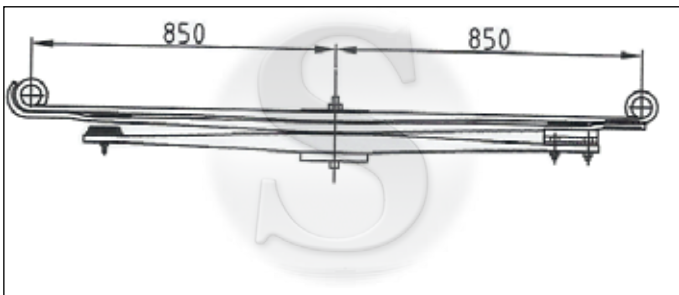

CODE	TYPE	LEA- VES	MATERIAL SIZE	LENGTH		EYE	
				F	R	F	R
5030150		2/1		850 - 850			
5030151			80x19				
5030152			80x19				
5030153			80x45				

Any reference to manufacture' s numbers are for the comparison purpose only. Alle Hersteller-Referenzen dien nur zu Vergleichswecken. Les references constructeur servent uniquement atitre d' indetification

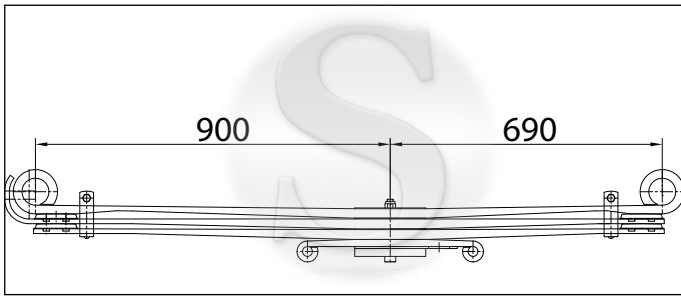

CODE	TYPE	LEAVES	MATERIAL SIZE	LENGTH		EYE	
				F	R	F	R
5030910		3		900 - 695			
5030911			90x24				
5030912			90x24				
5030913			90x24				

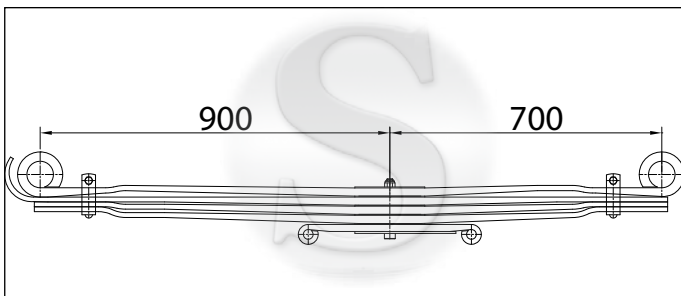

CODE	TYPE	LEAVES	MATERIAL SIZE	LENGTH		EYE	
				F	R	F	R
5031110		4		900 - 700			
5031111			90x24				
5031112			90x24				
5031113			90x24				
5031114			90x24				

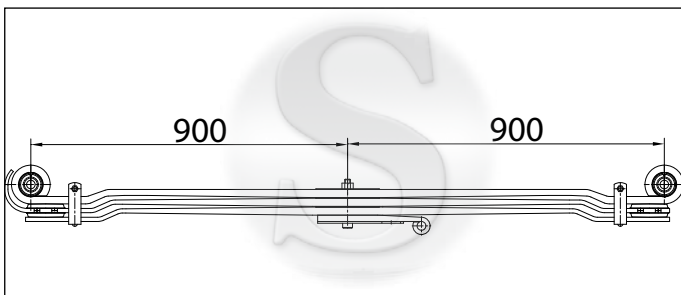

CODE	TYPE	LEAVES	MATERIAL SIZE	LENGTH		EYE	
				F	R	F	R
5030830		3		900 - 900			
5030831			90x24				
5030832			90x24				
5030833			90x24				

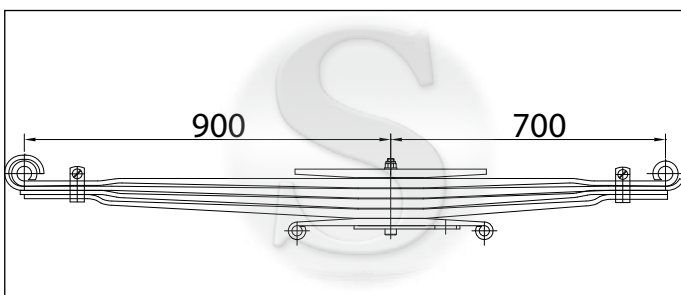

CODE	TYPE	LEAVES	MATERIAL SIZE	LENGTH		EYE	
				F	R	F	R
5031500	TGA	4		900 - 700			
5031501	F2000		90x24				
5031502	M90		90x24				
5031503	M2000		90x24				
5031504	F90		90x24				

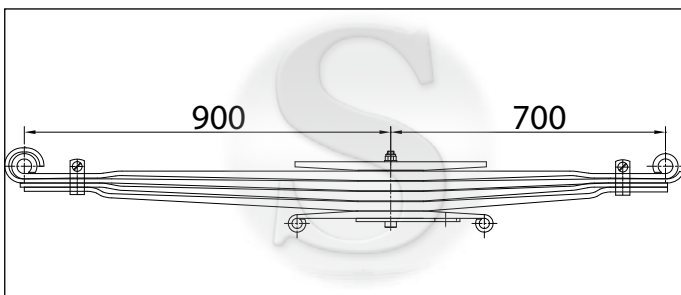

CODE	TYPE	LEAVES	MATERIAL SIZE	LENGTH		EYE	
				F	R	F	R
5030210	F13	3		900 - 700			
5030211	F14		90x22				
5030212	F17		90x22				
5030213	25-28T		90x22				
5030214	30-32T		90x22				
	35-41T						

Any reference to manufacture' s numbers are for the comparison purpose only. Alle Hersteller-Referenzen dien nur zu Vergleichswecken. Les references constructeur servent uniquement atitre d' indetification

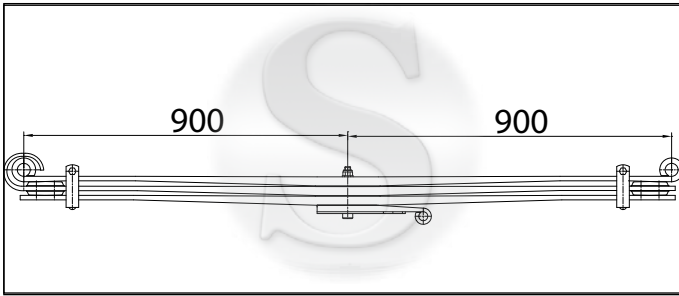

CODE	TYPE	LEA- VES	MATERIAL SIZE	LENGTH		EYE	
				F	R	F	R
5031900	19-422	3		900 - 900			
5031901			90x24				
5031902			90x24				
5031903			90x24				

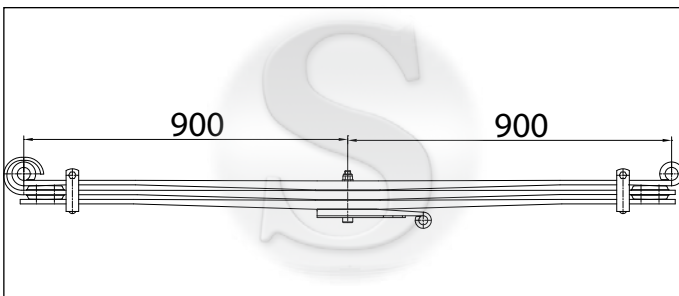

CODE	TYPE	LEA- VES	MATERIAL SIZE	LENGTH		EYE	
				F	R	F	R
5031400		3		900 - 900			
5031401			90x25				
5031402			90x25				
5031403			90x25				

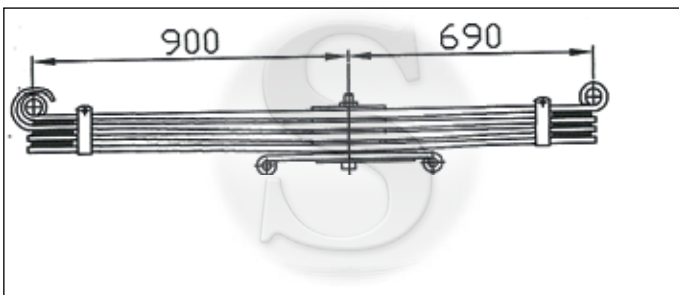

CODE	TYPE	LEA- VES	MATERIAL SIZE	LENGTH		EYE	
				F	R	F	R
5032500		4		900 - 690			
5032501			90x24				
5032502			90x24				
5032503			90x24				
5032504			90x24				

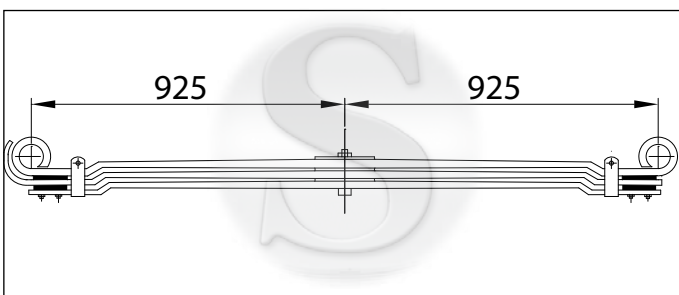

CODE	TYPE	LEA- VES	MATERIAL SIZE	LENGTH		EYE	
				F	R	F	R
5032440		3		925 - 925			
5032441			90x26				
5032442			90x26				
5032443			90x26				

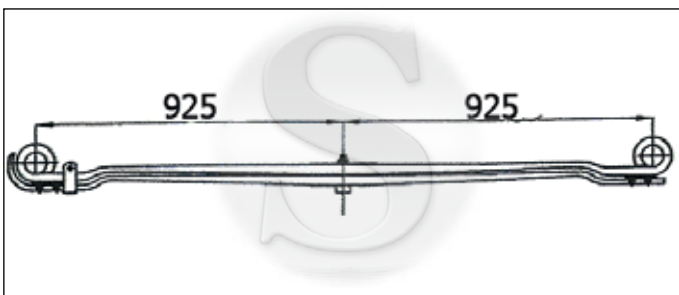

CODE	TYPE	LEA- VES	MATERIAL SIZE	LENGTH		EYE	
				F	R	F	R
5032430		2		925 - 925			
5032431			90x28				
5032432			90x28				

Any reference to manufacture' s numbers are for the comparison purpose only. Alle Hersteller-Referenzen dien nur zu Vergleichswecken. Les references constructeur servent uniquement atitre d' indetification

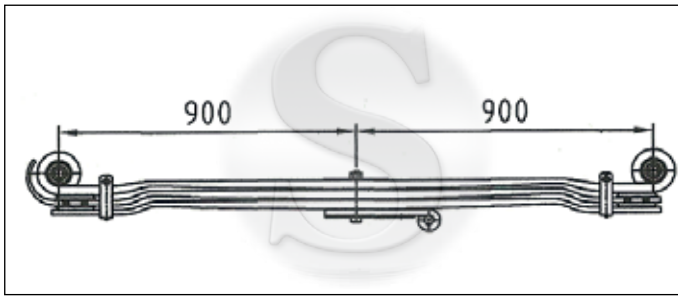

CODE	TYPE	LEA- VES	MATERIAL SIZE	LENGTH		EYE	
				F	R	F	R
5032480		3		800 - 800			
5032481			90x21				
5032482			90x21				
5032483			90x21				

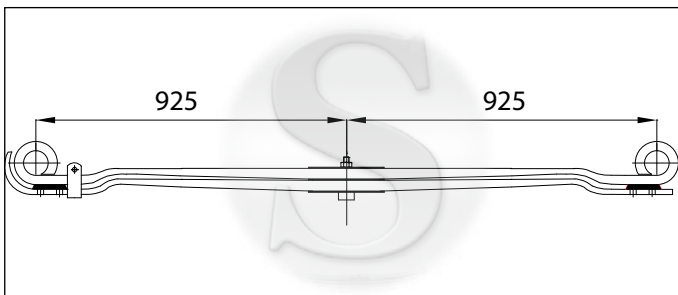

CODE	TYPE	LEA- VES	MATERIAL SIZE	LENGTH		EYE	
				F	R	F	R
5030140		2		925 - 925			
5030141			90x30				
5030142			90x30				

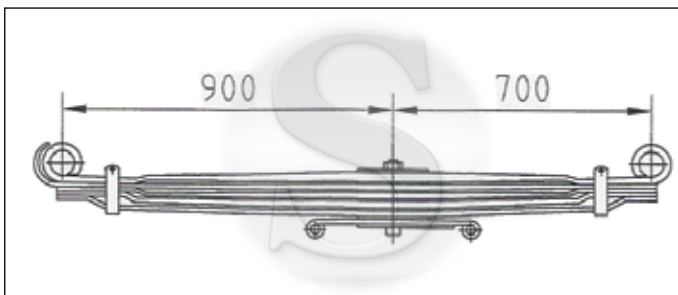

CODE	TYPE	LEA- VES	MATERIAL SIZE	LENGTH		EYE	
				F	R	F	R
5032520		5		900 - 700			
5032521			90x22				
5032522			90x22				
5032523			90x22				
5032524			90x22				
5032525			90x22				

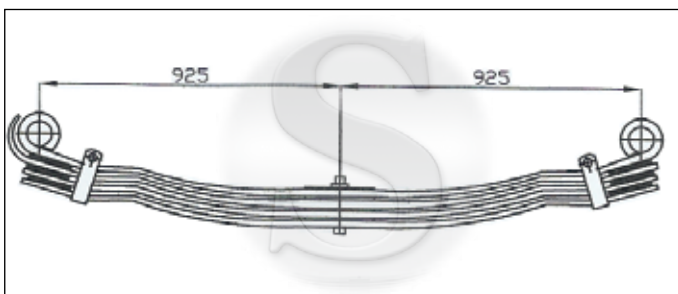

CODE	TYPE	LEA- VES	MATERIAL SIZE	LENGTH		EYE	
				F	R	F	R
5032190		4		925 - 925			
5032191			90x22				
5032192			90x24				
5032193			90x24				
5032194			90x24				

Any reference to manufacture' s numbers are for the comparison purpose only. Alle Hersteller-Referenzen dien nur zu Vergleichswecken. Les references constructeur servent uniquement atitre d' indetification

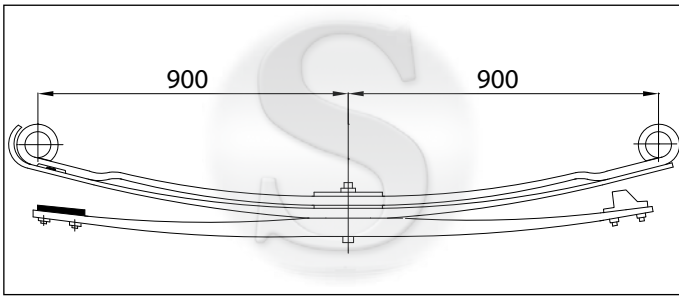

CODE	TYPE	LEA- VES	MATERIAL SIZE	LENGTH		EYE	
				F	R	F	R
5032180		2/1		900 - 900			
5032181			90x30				
5032182			90x30				
5032183			90x45				

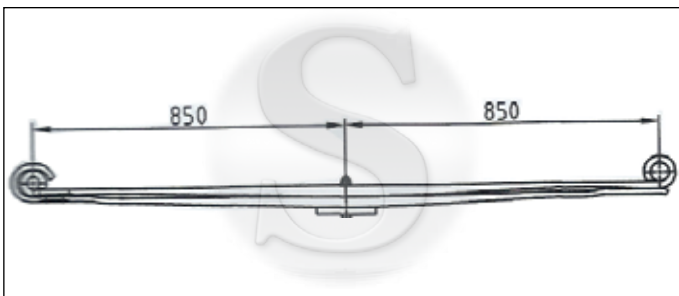

CODE	TYPE	LEA- VES	MATERIAL SIZE	LENGTH		EYE	
				F	R	F	R
5032450		2		850 - 850			
5032451			80x26				
5032452			80x26				

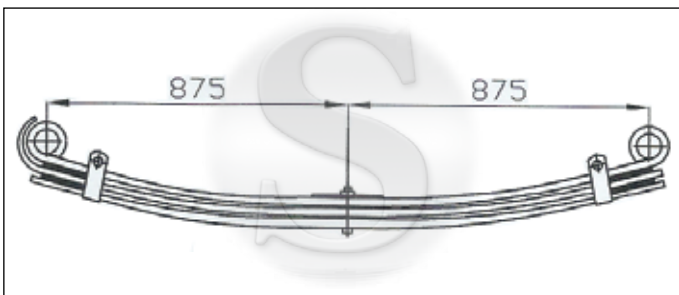

CODE	TYPE	LEA- VES	MATERIAL SIZE	LENGTH		EYE	
				F	R	F	R
5032170		3		875 - 875			
5032171			80x25				
5032172			80x25				
5032173			80x25				

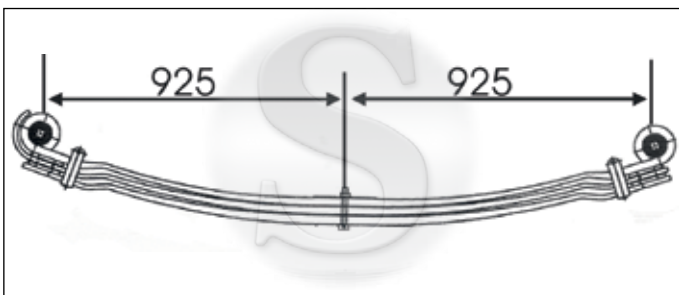

CODE	TYPE	LEA- VES	MATERIAL SIZE	LENGTH		EYE	
				F	R	F	R
5032010		3		925 - 925			
5032011	33.412		90x27				
5032012			90x27				
5032013			90x27				

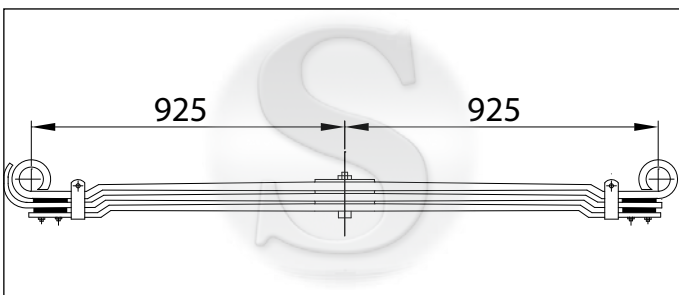

CODE	TYPE	LEA- VES	MATERIAL SIZE	LENGTH		EYE	
				F	R	F	R
5032440		3		925 - 925			
5032441			90x26				
5032442			90x26				
5032443			90x26				

Any reference to manufacture' s numbers are for the comparison purpose only. Alle Hersteller-Referenzen dien nur zu Vergleichswecken. Les references constructeur servent uniquement atitre d' indetification

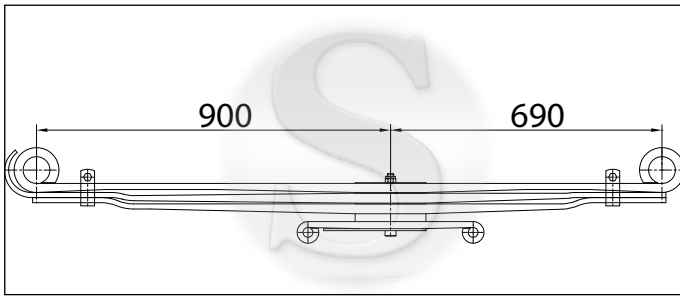

CODE	TYPE	LEA- VES	MATERIAL SIZE	LENGTH		EYE	
				F	R	F	R
5032120		3		900 - 690			
5032121			90x24				
5032122			90x25				
5032123			90x25				

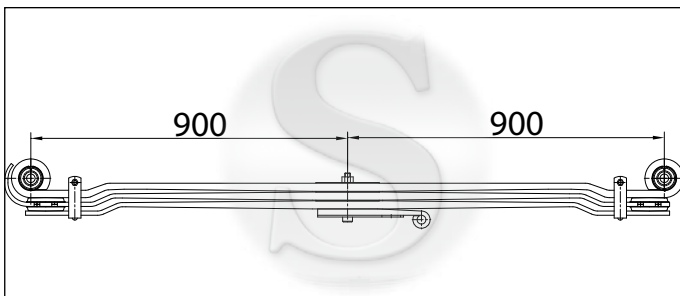

CODE	TYPE	LEA- VES	MATERIAL SIZE	LENGTH		EYE	
				F	R	F	R
5031600	F2000	3		900 - 900			
5031601			90x23				
5031602			90x25				
5031603			90x27				

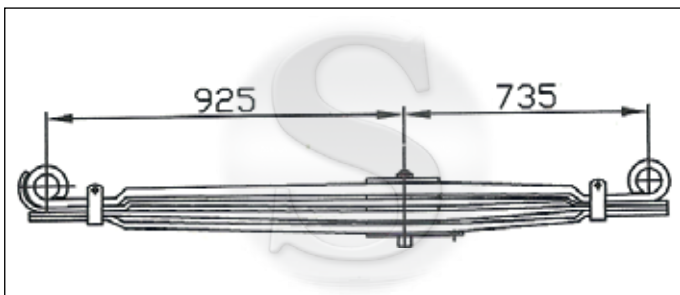

CODE	TYPE	LEA- VES	MATERIAL SIZE	LENGTH		EYE	
				F	R	F	R
5032160		4		925 - 735			
5032161			90x25				
5032162			90x25				
5032163			90x25				
5032164			90x25				

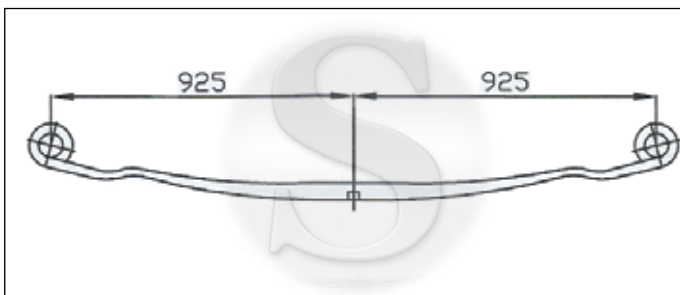

CODE	TYPE	LEA- VES	MATERIAL SIZE	LENGTH		EYE	
				F	R	F	R
5032600		1	90x40	925 - 925			

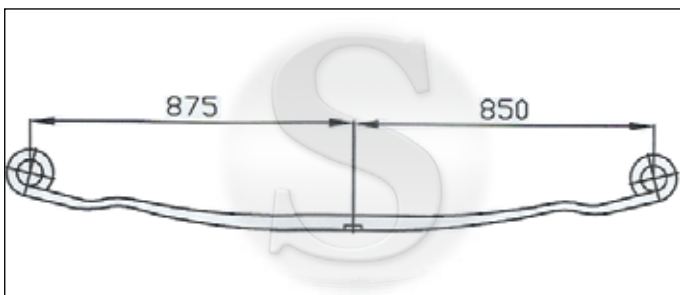

CODE	TYPE	LEA- VES	MATERIAL SIZE	LENGTH		EYE	
				F	R	F	R
5032200		1	90x30	875 - 875			

Any reference to manufacture' s numbers are for the comparison purpose only. Alle Hersteller-Referenzen dien nur zu Vergleichswecken. Les references constructeur servent uniquement atitre d' indetification

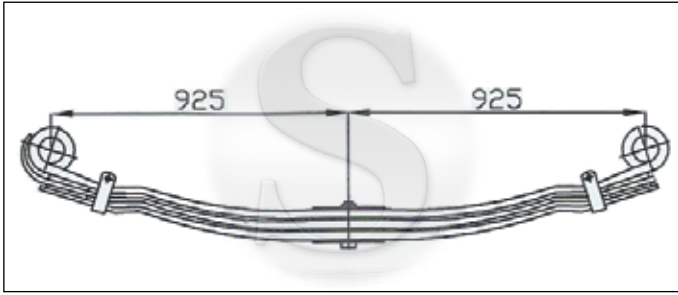

CODE	TYPE	LEAVES	MATERIAL SIZE	LENGTH		EYE	
				F	R	F	R
5032300		3		925	925		
5032301			90x27				
5032302			90x27				
5032303			90x27				

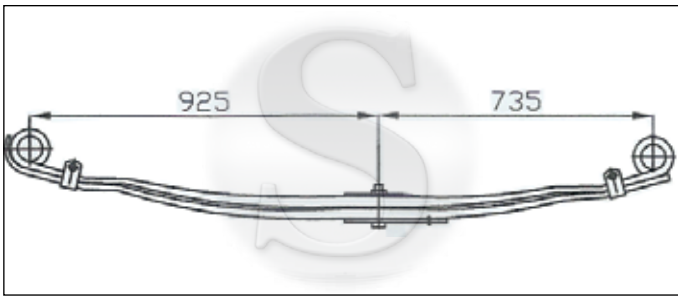

CODE	TYPE	LEAVES	MATERIAL SIZE	LENGTH		EYE	
				F	R	F	R
5030230		2		925	735		
5030231			90x30				
5030232			90x30				

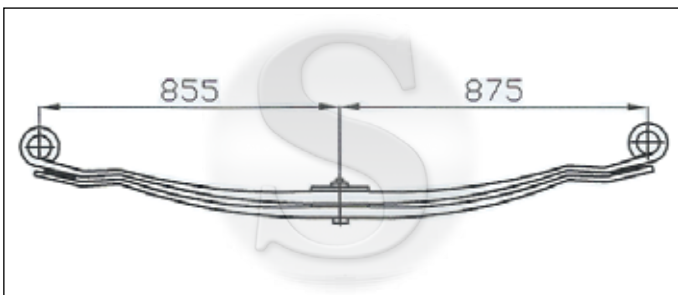

CODE	TYPE	LEAVES	MATERIAL SIZE	LENGTH		EYE	
				F	R	F	R
5030240		2		855	875		
5030241			90x24				
5030242			90x24				

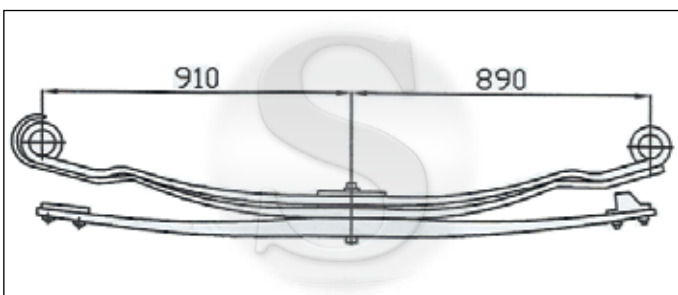

CODE	TYPE	LEAVES	MATERIAL SIZE	LENGTH		EYE	
				F	R	F	R
5030220		2/1		910	890		
5030221			80x27				
5030222			80x27				
5030223			80x48				

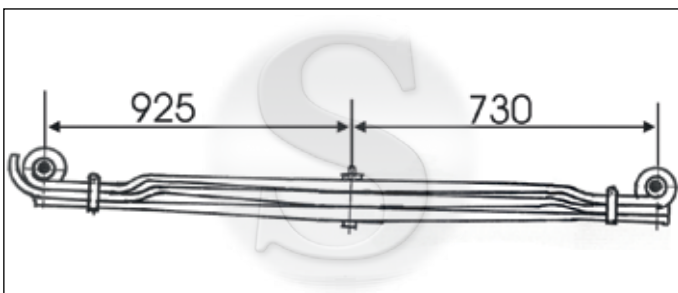

CODE	TYPE	LEAVES	MATERIAL SIZE	LENGTH		EYE	
				F	R	F	R
5031910		3		925	730		
5031911			90x25				
5031912			90x25				
5031913			90x25				

Any reference to manufacture' s numbers are for the comparison purpose only. Alle Hersteller-Referenzen dien nur zu Vergleichswecken. Les references constructeur servent uniquement atitre d' indetification

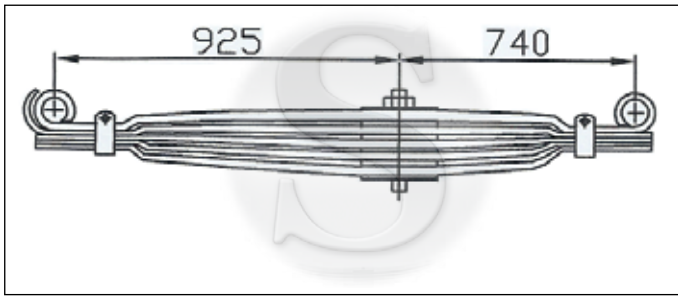

CODE	TYPE	LEA- VES	MATERIAL SIZE	LENGTH		EYE	
				F	R	F	R
5032110	TGA	5		925 - 740			
5032111			90x24				
5032112			90x22				
5032113			90x22				
5032114			90x22				
5032115			90x22				

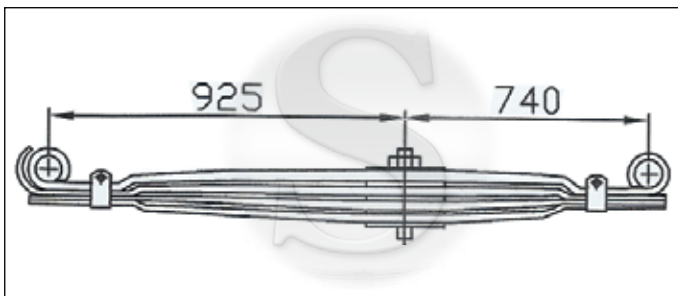

CODE	TYPE	LEA- VES	MATERIAL SIZE	LENGTH		EYE	
				F	R	F	R
5032510	TGA	3		925 - 740			
5032511			90x23				
5032512			90x23				
5032513			90x23				

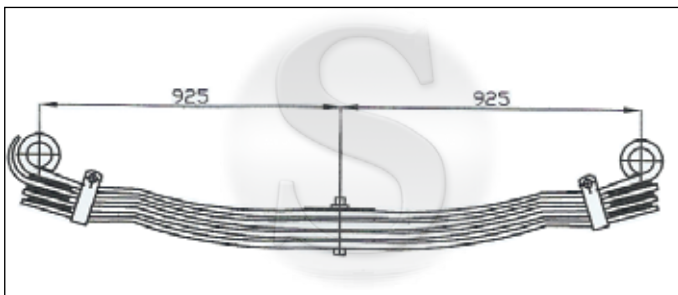

CODE	TYPE	LEA- VES	MATERIAL SIZE	LENGTH		EYE	
				F	R	F	R
5032620				925 - 925			
5032621			90x24				
5032622			90x24				
5032623			90x24				
5032624			90x24				

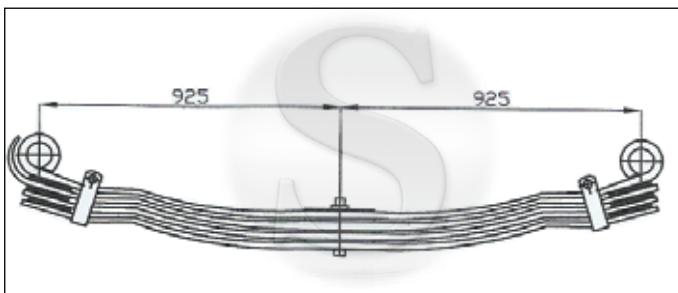

CODE	TYPE	LEA- VES	MATERIAL SIZE	LENGTH		EYE	
				F	R	F	R
5032610				925 - 925			
5032611			90x23				
5032612			90x24				
5032613			90x24				
5032614			90x24				

Any reference to manufacture' s numbers are for the comparison purpose only. Alle Hersteller-Referenzen dien nur zu Vergleichswecken. Les references constructeur servent uniquement atitre d' indetification

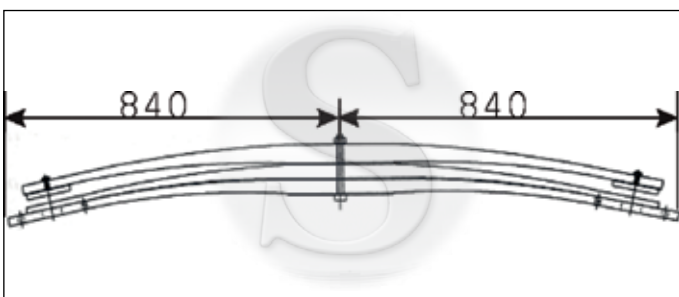
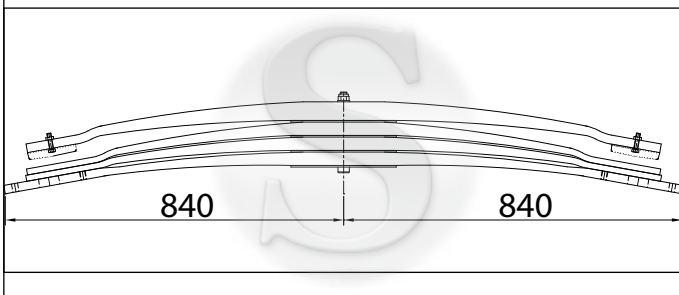
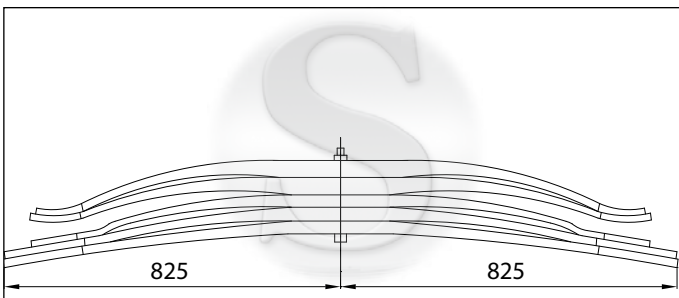
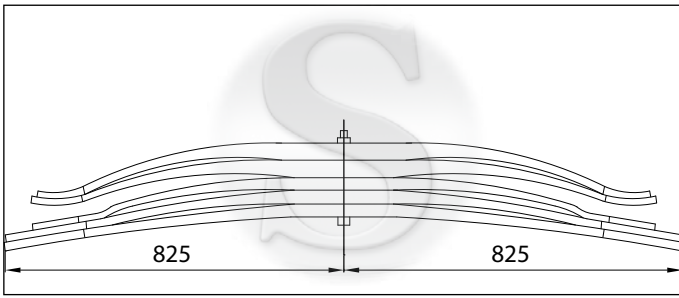

CODE	TYPE	LEAVES	MATERIAL SIZE	LENGTH		EYE	
				F	R	F	R
5032310	TGA	5		825 - 825			
5032311			100x31				
5032312			100x31				
5032313			100x31				
5032314			100x42				
5032315			100x42				

CODE	TYPE	LEAVES	MATERIAL SIZE	LENGTH		EYE	
				F	R	F	R
5032410	TGA	5		825 - 825			
5032411			100x31				
5032412			100x31				
5032413			100x31				
5032414			100x35				
5032415			100x35				

CODE	TYPE	LEAVES	MATERIAL SIZE	LENGTH		EYE	
				F	R	F	R
5030630		4		835 - 835			
5030631			100x33				
5030632			100x33				
5030633			100x33				
5030634			100x47				

CODE	TYPE	LEAVES	MATERIAL SIZE	LENGTH		EYE	
				F	R	F	R
5030620	24,242	3		840 - 840			
5030621	24,262		100x33				
5030622	24,292		100x33				
5030623	24,332		100x46				
	24,362						
	32,292						

Any reference to manufacture' s numbers are for the comparison purpose only. Alle Hersteller-Referenzen dien nur zu Vergleichswecken. Les references constructeur servent uniquement atitre d' indetification

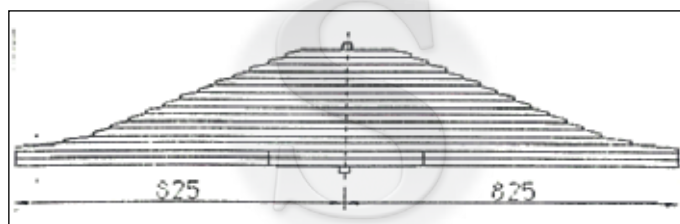
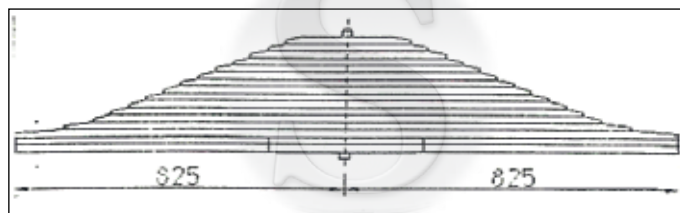
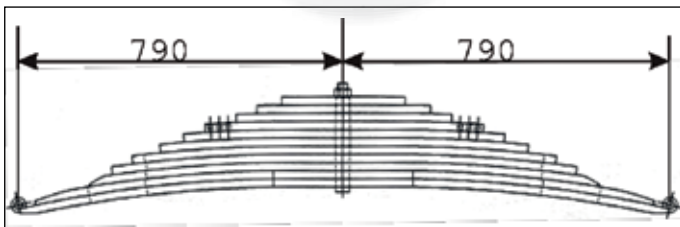
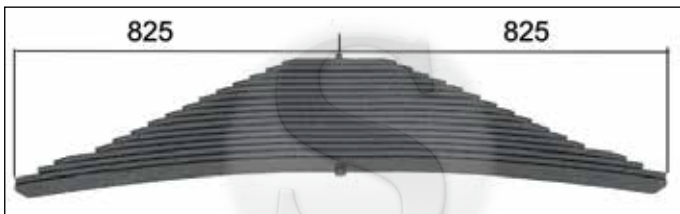
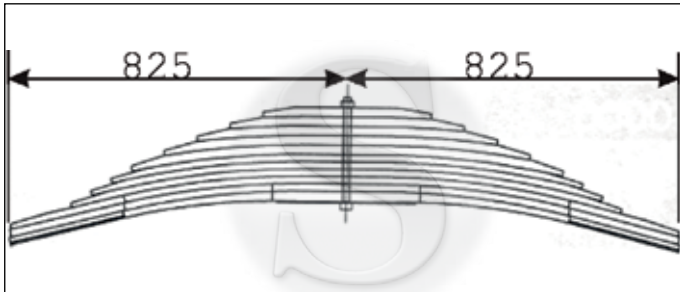

CODE	TYPE	LEAVES	MATERIAL SIZE	LENGTH		EYE	
				F	R	F	R
5030720		11		825 - 825			
5030721			100x26				
5030722			100x19				
5030723			100x18				
5030724			100x18				
5030725			100x18				
5030726			100x18				
5030727			100x23				
5030728			100x23				
5030729			100x23				
5030730			100x23				
5030731			100x23				

CODE	TYPE	LEAVES	MATERIAL SIZE	LENGTH		EYE	
				F	R	F	R
6032700		16		825 - 825			
			100x18				

CODE	TYPE	LEAVES	MATERIAL SIZE	LENGTH		EYE	
				F	R	F	R
6030420		11		790 - 790			
			100x20				

CODE	TYPE	LEAVES	MATERIAL SIZE	LENGTH		EYE	
				F	R	F	R
6030430		16		825 - 825			
			100x18				

CODE	TYPE	LEAVES	MATERIAL SIZE	LENGTH		EYE	
				F	R	F	R
6030710	TGA	16	100x20	825 - 825			
	TGS						
	TGX						

Any reference to manufacture' s numbers are for the comparison purpose only. Alle Hersteller-Referenzen dien nur zu Vergleichswecken. Les references constructeur servent uniquement atitre d' indetification

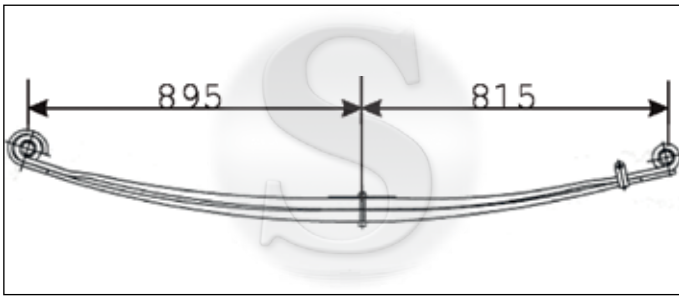

CODE	TYPE	LEA- VES	MATERIAL SIZE	LENGTH		EYE	
				F	R	F	R
5011210	F10	2		895 - 815			
5011211	F12		100x30				
5011212	F16		100x30				

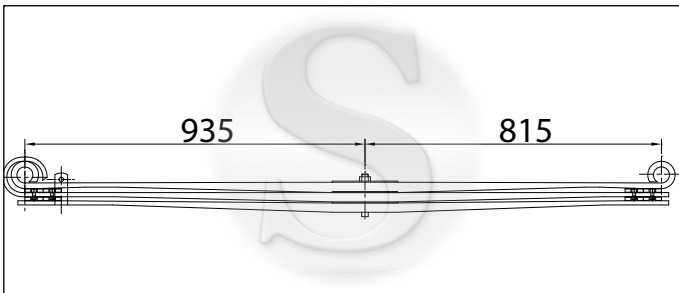

CODE	TYPE	LEA- VES	MATERIAL SIZE	LENGTH		EYE	
				F	R	F	R
5010910	F10	3		935 - 815			
5010911	F12		100x25				
5010912	FL10		100x25				
5010913	FL7		100x25				

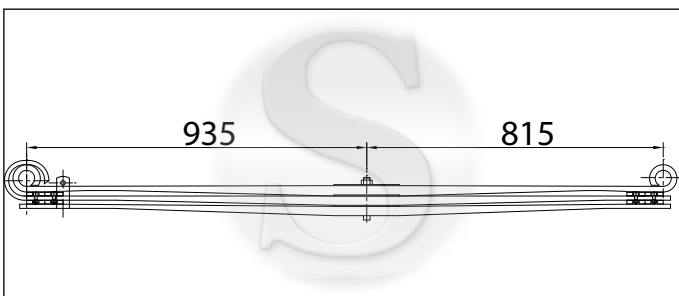

CODE	TYPE	LEA- VES	MATERIAL SIZE	LENGTH		EYE	
				F	R	F	R
5010710	F10	3		935 - 815			
5010711	F12		100x26				
5010712	N10		100x26				
5010713	N12		100x26				

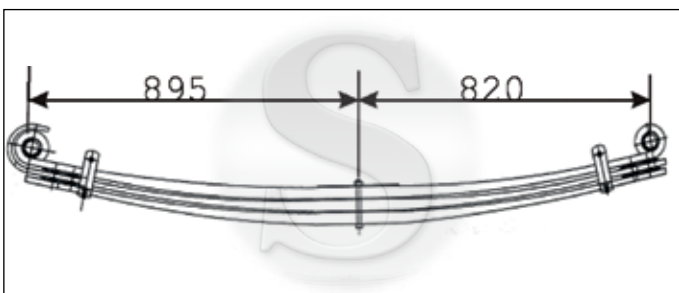

CODE	TYPE	LEA- VES	MATERIAL SIZE	LENGTH		EYE	
				F	R	F	R
5010620	F10	3		895 - 820			
5010621	F12		100x32				
5010622	FL7		100x32				
5010623	FL10		100x32				

Any reference to manufacture' s numbers are for the comparison purpose only. Alle Hersteller-Referenzen dien nur zu Vergleichswecken. Les references constructeur servent uniquement atitre d' indetification

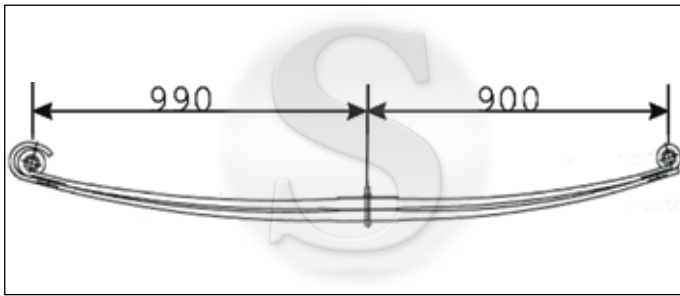

CODE	TYPE	LEAVES	MATERIAL SIZE	LENGTH		EYE	
				F	R	F	R
5011310	FH12	2		990 - 900			
5011311	FH16		100x32				
5011312	4x2		100x32				
	6x2						
	6x4						

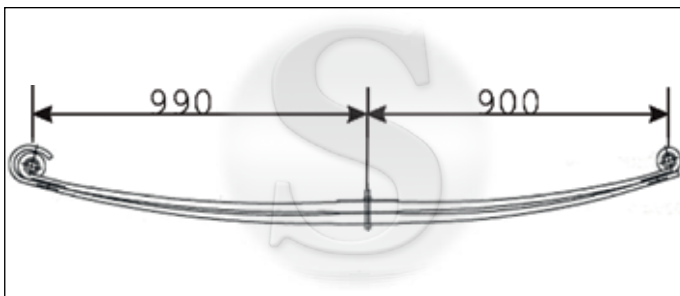

CODE	TYPE	LEAVES	MATERIAL SIZE	LENGTH		EYE	
				F	R	F	R
5011710		2		990 - 900			
5011711			100x28				
5011712			100x30				

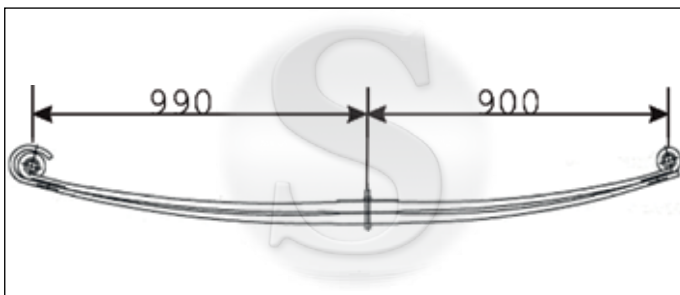

CODE	TYPE	LEAVES	MATERIAL SIZE	LENGTH		EYE	
				F	R	F	R
5011810		2		990 - 900			
5011811			100x28				
5011812			100x30				

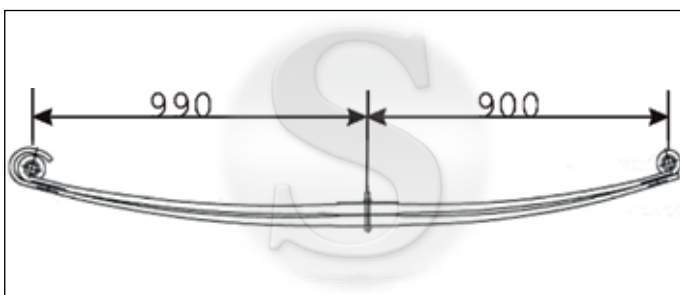

CODE	TYPE	LEAVES	MATERIAL SIZE	LENGTH		EYE	
				F	R	F	R
5012010	FH	2		990 - 900			
5012011	FL		100x28				
5012012	FM		100x30				

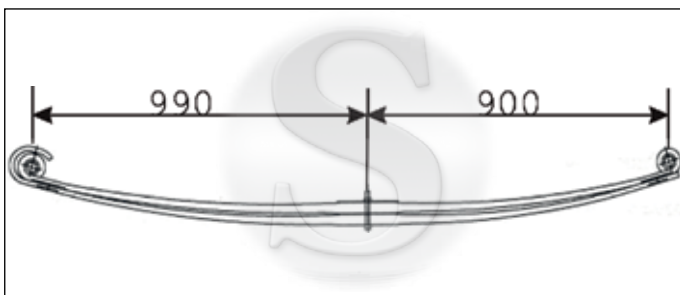

CODE	TYPE	LEAVES	MATERIAL SIZE	LENGTH		EYE	
				F	R	F	R
5012110		2		990 - 900			
5012111			100x30				
5012112			100x30				

Any reference to manufacture' s numbers are for the comparison purpose only. Alle Hersteller-Referenzen dien nur zu Vergleichswecken. Les references constructeur servent uniquement atitre d' indetification

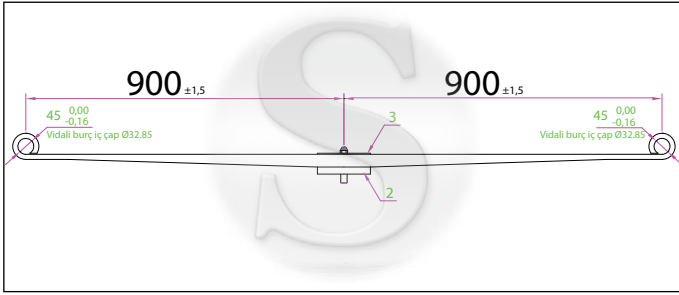

CODE	TYPE	LEAVES	MATERIAL SIZE	LENGTH		EYE	
				F	R	F	R
5012140	FL612	1	80x36	900 - 900			
	FL615						

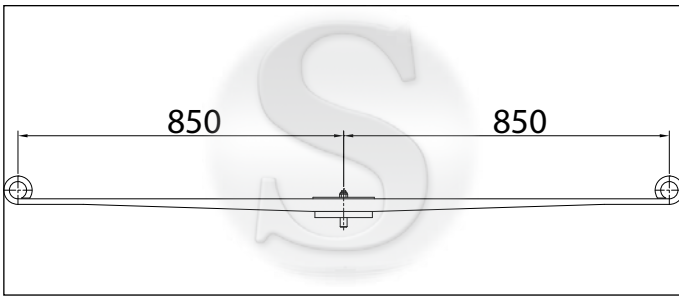

CODE	TYPE	LEAVES	MATERIAL SIZE	LENGTH		EYE	
				F	R	F	R
5012160	FL608	1	80x29	900 - 900			
	FL611						

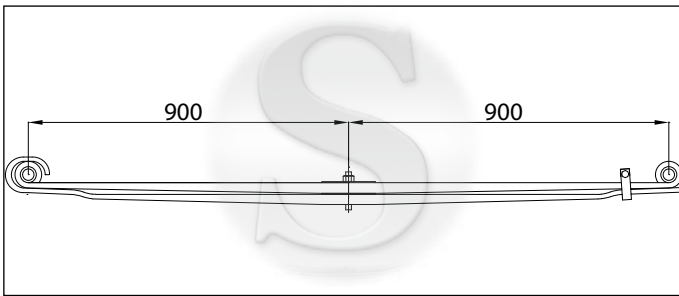

CODE	TYPE	LEAVES	MATERIAL SIZE	LENGTH		EYE	
				F	R	F	R
5012200	FL	2		900 - 900			
5012201			80x29				
5012202			80x29				

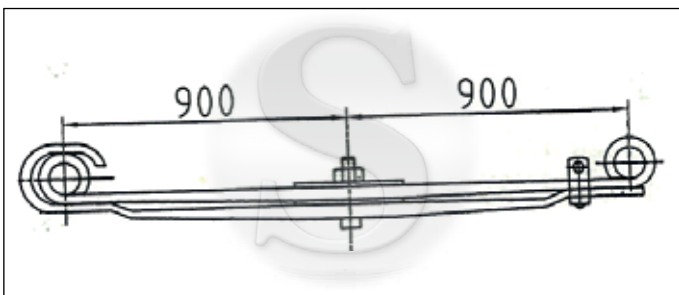

CODE	TYPE	LEAVES	MATERIAL SIZE	LENGTH		EYE	
				F	R	F	R
5012190		2		900 - 900			
5012191			100x30				
5012192			100x30				

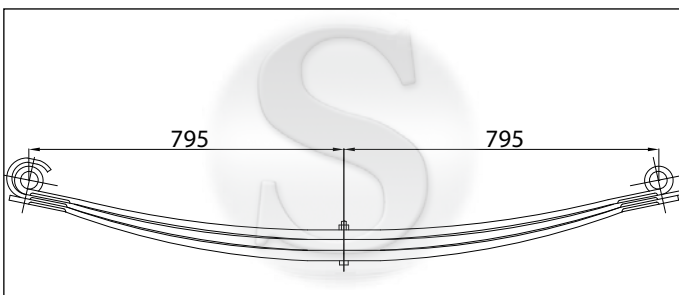

CODE	TYPE	LEAVES	MATERIAL SIZE	LENGTH		EYE	
				F	R	F	R
5012170	FM9	3		795 - 795			
5012171			100x22				
5012172			100x24				
5012173			100x24				

Any reference to manufacture's numbers are for the comparison purpose only. Alle Hersteller-Referenzen dien nur zu Vergleichswecken. Les references constructeur servent uniquement atitre d' indetification

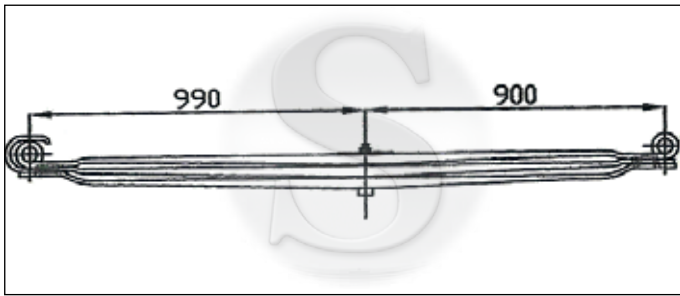

CODE	TYPE	LEA- VES	MATERIAL SIZE	LENGTH		EYE	
				F	R	F	R
5012210		3		990 - 900			
5012211			100x32				
5012212			100x32				
5012213			100x26				

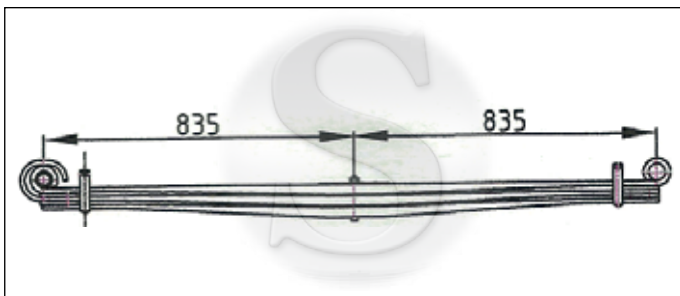

CODE	TYPE	LEA- VES	MATERIAL SIZE	LENGTH		EYE	
				F	R	F	R
5012300		3		835 - 835			
5012301			100x27				
5012302			100x27				
5012303			100x27				

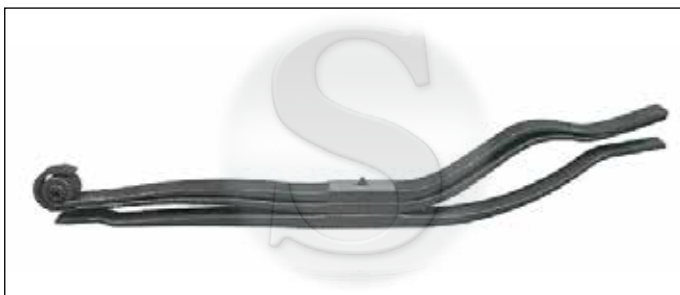

CODE	TYPE	LEA- VES	MATERIAL SIZE	LENGTH		EYE	
				F	R	F	R
5012270		3		905 - 970			
5012271			90x35				
5012272			90x35				
5012273			90x45				

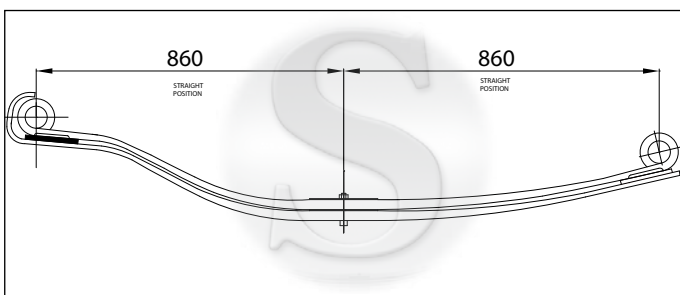

CODE	TYPE	LEA- VES	MATERIAL SIZE	LENGTH		EYE	
				F	R	F	R
5010760		2		822 - 842			
5010761			90x26				
5010762			90x27				

Any reference to manufacture' s numbers are for the comparison purpose only. Alle Hersteller-Referenzen dien nur zu Vergleichswecken. Les references constructeur servent uniquement atitre d' indetification

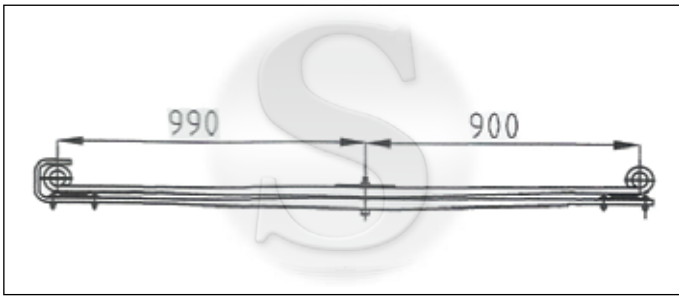

CODE	TYPE	LEA- VES	MATERIAL SIZE	LENGTH		EYE	
				F	R	F	R
5012180		2		990 - 900			
5012181			100x32				
5012182			100x32				

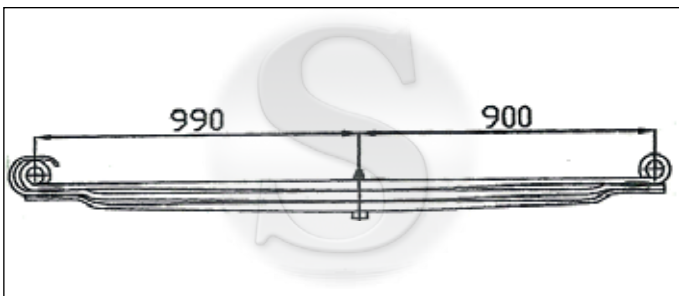

CODE	TYPE	LEA- VES	MATERIAL SIZE	LENGTH		EYE	
				F	R	F	R
5012220		3		990 - 900			
5012221			100x30				
5012222			100x30				
5012223			100x26				

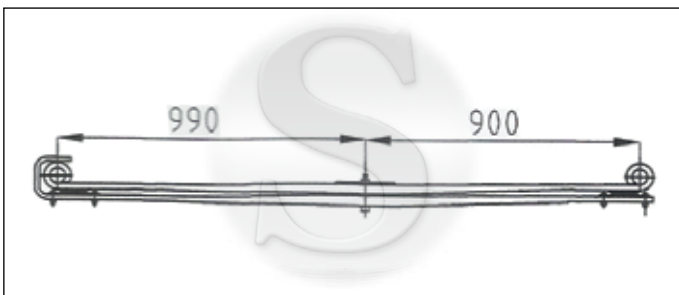

CODE	TYPE	LEA- VES	MATERIAL SIZE	LENGTH		EYE	
				F	R	F	R
5012260		2		990 - 900			
5012261			100x30				
5012262			100x30				

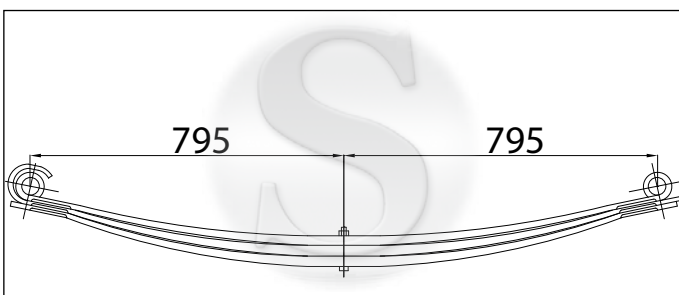

CODE	TYPE	LEA- VES	MATERIAL SIZE	LENGTH		EYE	
				F	R	F	R
5012230		3		795 - 795			
5012231			100x22				
5012232			100x24				
5012233			100x24				

Any reference to manufacture' s numbers are for the comparison purpose only. Alle Hersteller-Referenzen dien nur zu Vergleichswecken. Les references constructeur servent uniquement atitre d' indetification

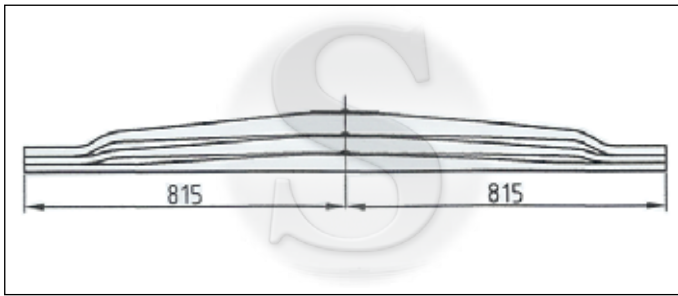

CODE	TYPE	LEA- VES	MATERIAL SIZE	LENGTH		EYE	
				F	R	F	R
5012240		3		815 - 815			
5012241			75x43				
5012242			75x43				
5012243			75x55				



CODE	TYPE	LEA- VES	MATERIAL SIZE	LENGTH		EYE	
				F	R	F	R
5012250		3		815 - 815			
5012251			75x47				
5012252			75x47				
5012253			75x55				

Any reference to manufacture' s numbers are for the comparison purpose only. Alle Hersteller-Referenzen dien nur zu Vergleichswecken. Les references constructeur servent uniquement atitre d' indetification

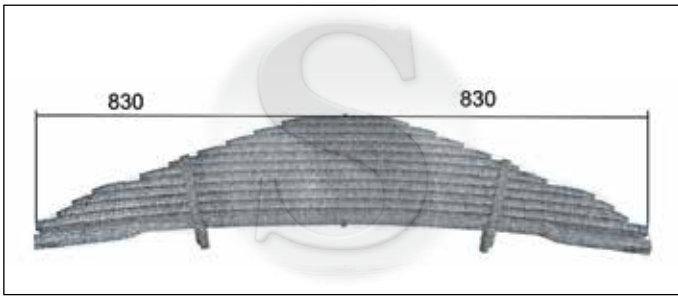

CODE	TYPE	LEAVES	MATERIAL SIZE	LENGTH		EYE	
				F	R	F	R
6010910		11	90x26	830	- 830		

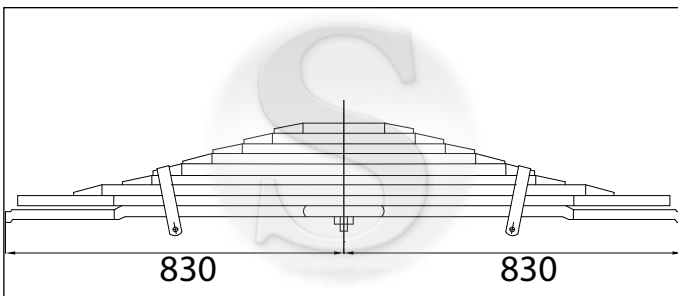

CODE	TYPE	LEAVES	MATERIAL SIZE	LENGTH		EYE	
				F	R	F	R
6010920		9	90x26	830	- 830		



CODE	TYPE	LEAVES	MATERIAL SIZE	LENGTH		EYE	
				F	R	F	R
6012230		9	75x26	830	- 830		

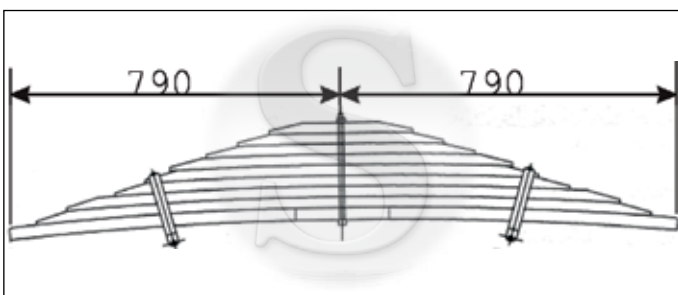

CODE	TYPE	LEAVES	MATERIAL SIZE	LENGTH		EYE	
				F	R	F	R
6010720		9	90x26	790	- 790		

Any reference to manufacture' s numbers are for the comparison purpose only. Alle Hersteller-Referenzen dien nur zu Vergleichswecken. Les references constructeur servent uniquement atitre d' indetification

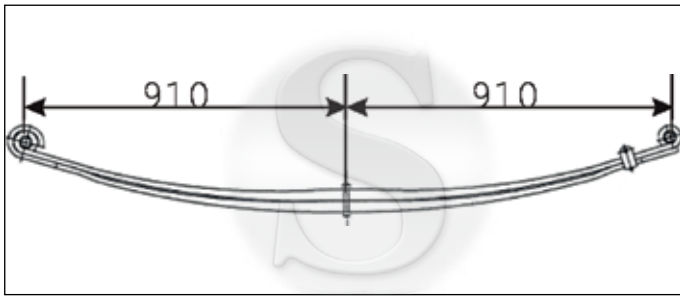

CODE	TYPE	LEAVES	MATERIAL SIZE	LENGTH		EYE	
				F	R	F	R
5040610	82/93	2		910	910		
5040611	113		90x30				
5040612	143		90x30				

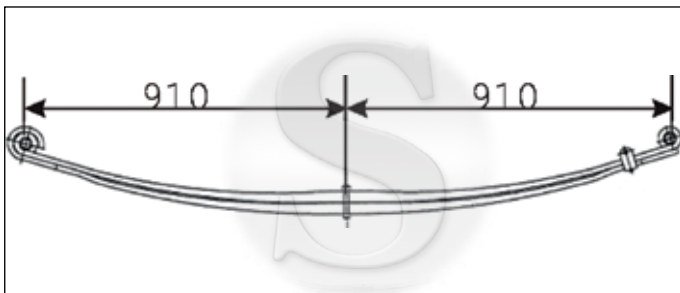

CODE	TYPE	LEAVES	MATERIAL SIZE	LENGTH		EYE	
				F	R	F	R
5041010	93	2		910	910		
5041011			90x32				
5041012			90x32				

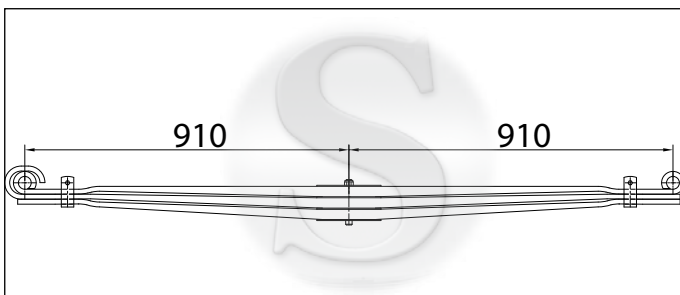

CODE	TYPE	LEAVES	MATERIAL SIZE	LENGTH		EYE	
				F	R	F	R
5040910		3		910	910		
5040911			90x29				
5040912			90x29				
5040913			90x29				

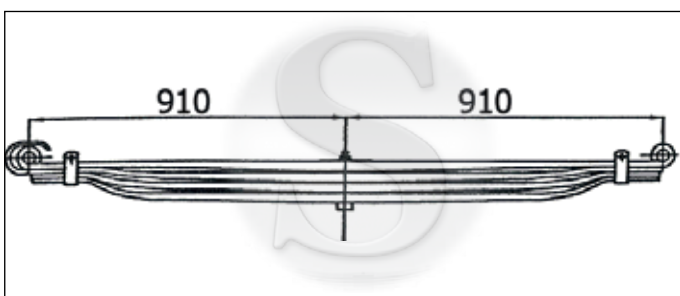

CODE	TYPE	LEAVES	MATERIAL SIZE	LENGTH		EYE	
				F	R	F	R
5040170		4		910	910		
5040171	P/G/R/T		90x28				
5040172			90x28				
5040173			90x28				
5040174			90x28				

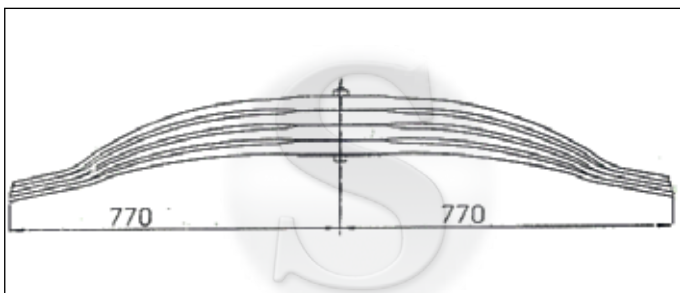

CODE	TYPE	LEAVES	MATERIAL SIZE	LENGTH		EYE	
				F	R	F	R
5040180		4		770	770		
5040181	P/G/R/T		90x41				
5040182			90x41				
5040183			90x41				
5040184			90x41				

Any reference to manufacture' s numbers are for the comparison purpose only. Alle Hersteller-Referenzen dien nur zu Vergleichswecken. Les references constructeur servent uniquement atitre d' indetification

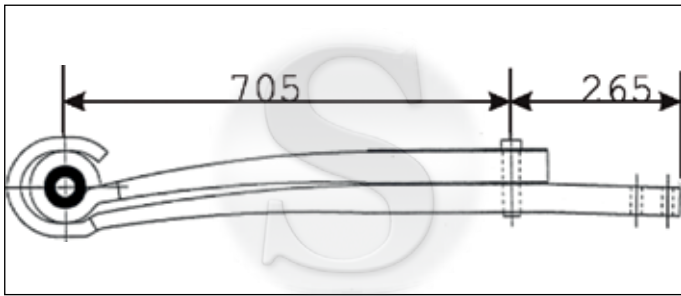

CODE	TYPE	LEA- VES	MATERIAL SIZE	LENGTH		EYE	
				F	R	F	R
5040820	3/4	2		705 - 265			
5040821			100x47				
5040822			100x44				

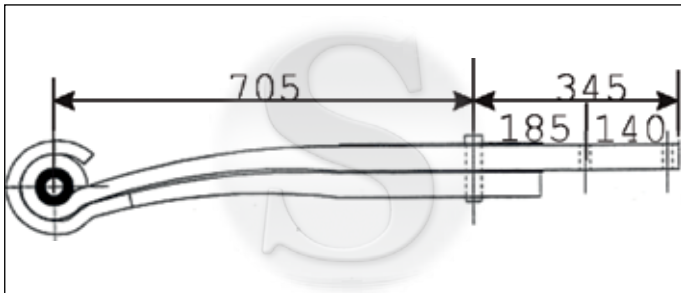

CODE	TYPE	LEA- VES	MATERIAL SIZE	LENGTH		EYE	
				F	R	F	R
5040520	82/92	2	120x40	705 - 345			
	93						
	113						
	142						
	143						

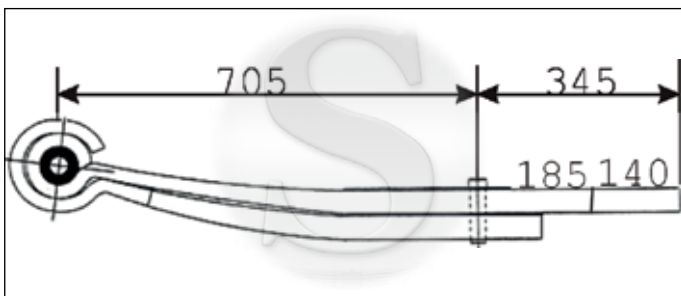

CODE	TYPE	LEA- VES	MATERIAL SIZE	LENGTH		EYE	
				F	R	F	R
5040230	82/92	2	120x40	705 - 345			
	112						
	142						

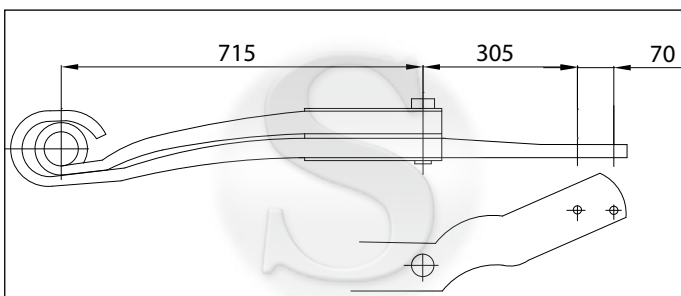

CODE	TYPE	LEA- VES	MATERIAL SIZE	LENGTH		EYE	
				F	R	F	R
5041040	P/G/R/T	2		714 - 400			
5041041			100x47				
5041042			100x44				

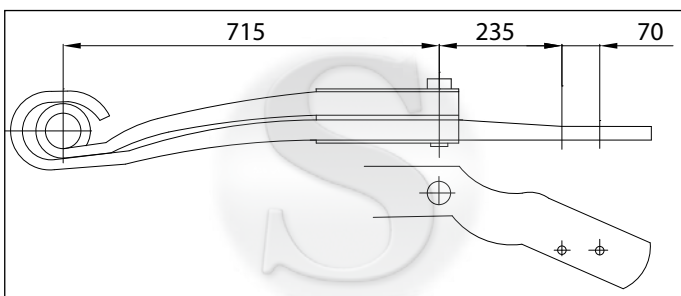

CODE	TYPE	LEA- VES	MATERIAL SIZE	LENGTH		EYE	
				F	R	F	R
5041050	P/G/R/T	2		714 - 400			
5041051			100x47				
5041052			100x44				

Any reference to manufacture's numbers are for the comparison purpose only. Alle Hersteller-Referenzen dien nur zu Vergleichswecken. Les references constructeur servent uniquement atitre d' indetification

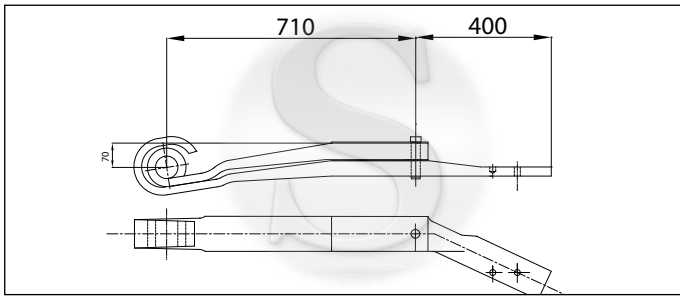

CODE	TYPE	LEA- VES	MATERIAL SIZE	LENGTH		EYE	
				F	R	F	R
5040120	310	2		710 - 410			
5040121	360		100x48				
5040122	P/G/R/T		100x44				

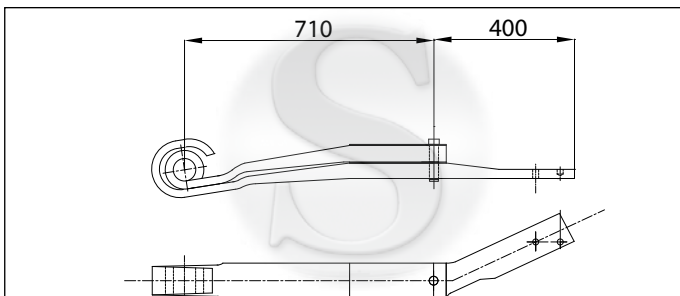

CODE	TYPE	LEA- VES	MATERIAL SIZE	LENGTH		EYE	
				F	R	F	R
5040130	310	2		710 - 410			
5040131	360		100x48				
5040132	P/G/R/T		100x44				

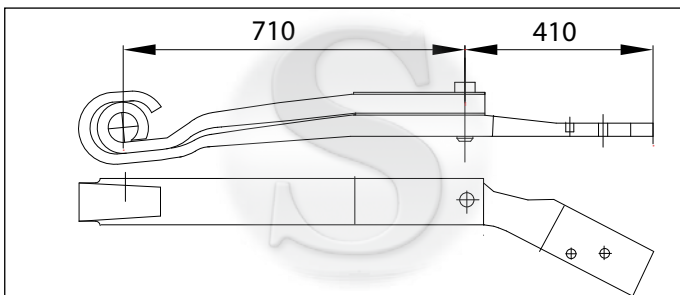

CODE	TYPE	LEA- VES	MATERIAL SIZE	LENGTH		EYE	
				F	R	F	R
5040160	SER4	2		710 - 410			
5040161	P/G/R/T		100x47				
5040162			100x44				

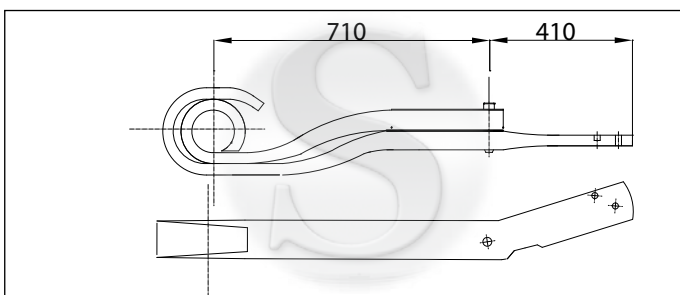

CODE	TYPE	LEA- VES	MATERIAL SIZE	LENGTH		EYE	
				F	R	F	R
5040150	SER4	2		710 - 410			
5040151	P/G/R/T		100x47				
5040152			100x44				

Any reference to manufacture' s numbers are for the comparison purpose only. Alle Hersteller-Referenzen dien nur zu Vergleichswecken. Les references constructeur servent uniquement atitre d' indetification

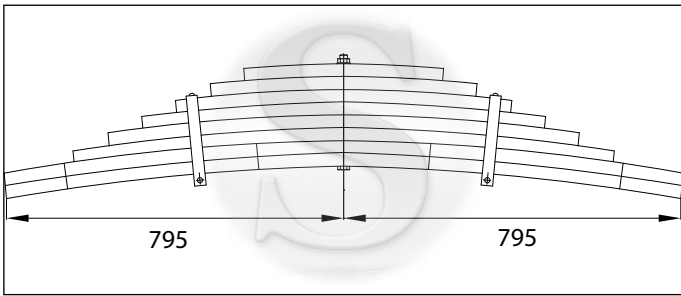

CODE	TYPE	LEAVES	MATERIAL SIZE	LENGTH		EYE	
				F	R	F	R
6040190	P/G/R/T	8	90x30	830	830		

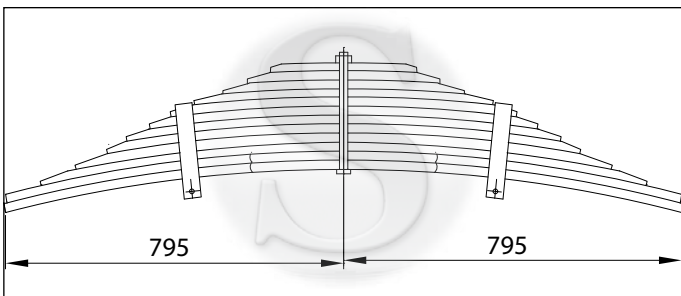

CODE	TYPE	LEAVES	MATERIAL SIZE	LENGTH		EYE	
				F	R	F	R
6040130	6x4 P/G/R/T	12	90x20	795	795		

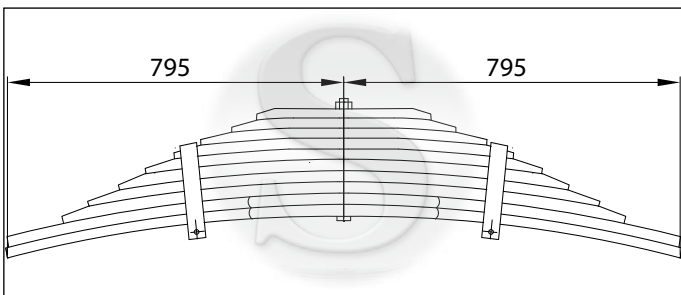

CODE	TYPE	LEAVES	MATERIAL SIZE	LENGTH		EYE	
				F	R	F	R
6040120	6x4 P/G/R/T	10	90x25	795	795		

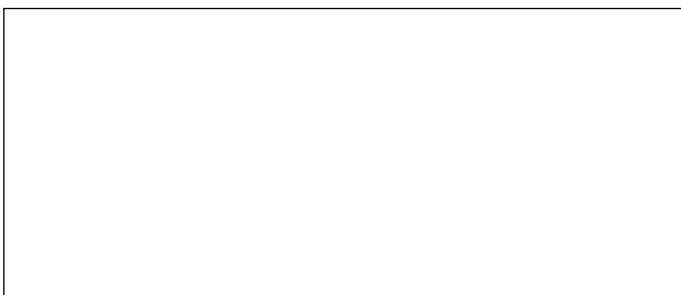

CODE	TYPE	LEAVES	MATERIAL SIZE	LENGTH		EYE	
				F	R	F	R
6040150		10	90x20	770	770		

Any reference to manufacture's numbers are for the comparison purpose only. Alle Hersteller-Referenzen dien nur zu Vergleichswecken. Les references constructeur servent uniquement atitre d' indetification

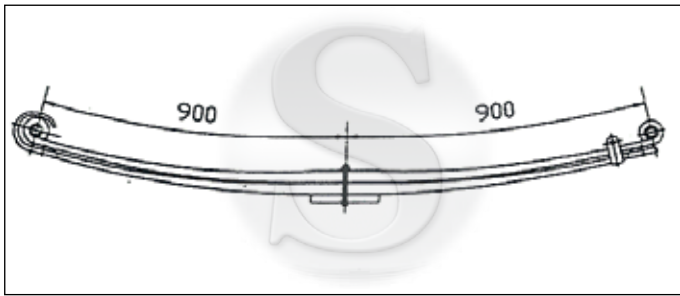

CODE	TYPE	LEA- VES	MATERIAL SIZE	LENGTH		EYE	
				F	R	F	R
5020910	F85	2		900 - 900			
5020911	FAT75		80x32				
5020912	XE95		80x32				

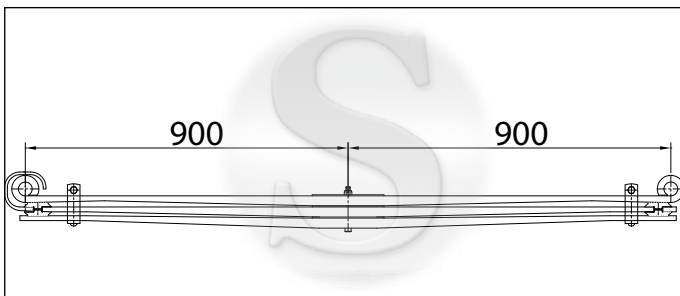

CODE	TYPE	LEA- VES	MATERIAL SIZE	LENGTH		EYE	
				F	R	F	R
5020610	F95			900 - 900			
5020611			80x28				
5020612			80x28				
5020613			80x28				

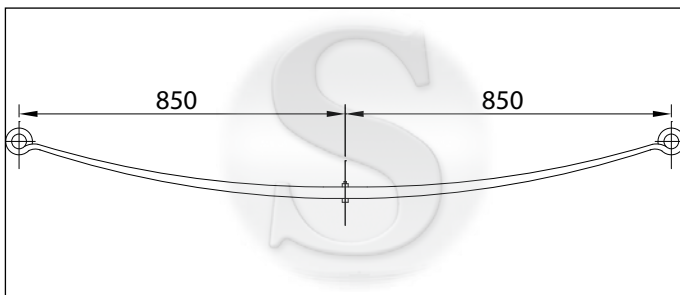

CODE	TYPE	LEA- VES	MATERIAL SIZE	LENGTH		EYE	
				F	R	F	R
5020520		1	75x35	950 - 950			

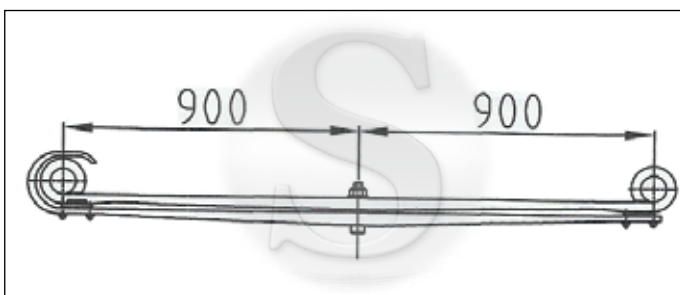

CODE	TYPE	LEA- VES	MATERIAL SIZE	LENGTH		EYE	
				F	R	F	R
5020920	CF75			900 - 900			
5020921	CF85		80x28				
5020922	XF95		80x30				
	XF105						

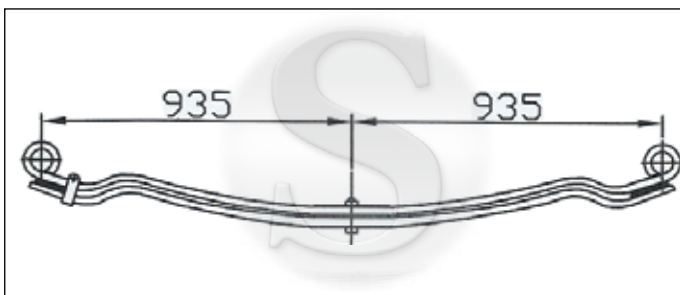

CODE	TYPE	LEA- VES	MATERIAL SIZE	LENGTH		EYE	
				F	R	F	R
5020310	LF45	3		935 - 935			
5020311	LF55/65		90x29				
5020312	LFεκτο6		90x30				
	CF65						
	CFεκτο6						

Any reference to manufacture' s numbers are for the comparison purpose only. Alle Hersteller-Referenzen dien nur zu Vergleichswecken. Les references constructeur servent uniquement atitre d' indetification

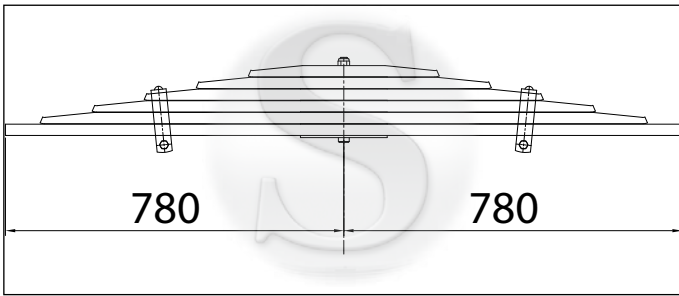

CODE	TYPE	LEA- VES	MATERIAL SIZE	LENGTH		EYE	
				F	R	F	R
6020110		6	90x29	780 - 780			

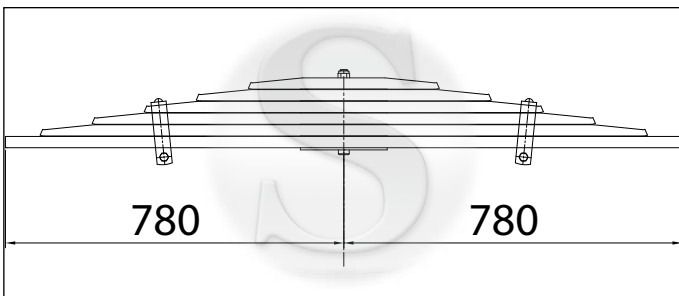

CODE	TYPE	LEA- VES	MATERIAL SIZE	LENGTH		EYE	
				F	R	F	R
6020120		6	90x26	780 - 780			

Any reference to manufacture' s numbers are for the comparison purpose only. Alle Hersteller-Referenzen dien nur zu Vergleichswecken. Les references constructeur servent uniquement atitre d' indetification

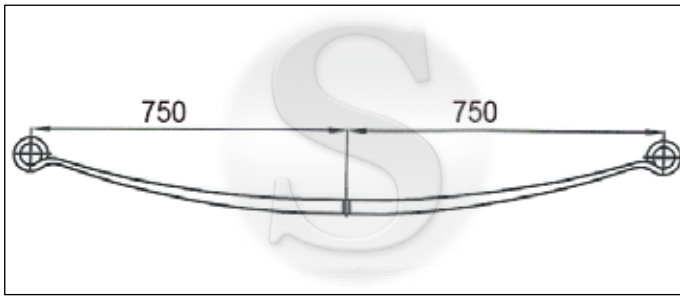

CODE	TYPE	LEA- VES	MATERIAL SIZE	LENGTH		EYE	
				F	R	F	R
5080300		1	80x24	750 - 750			

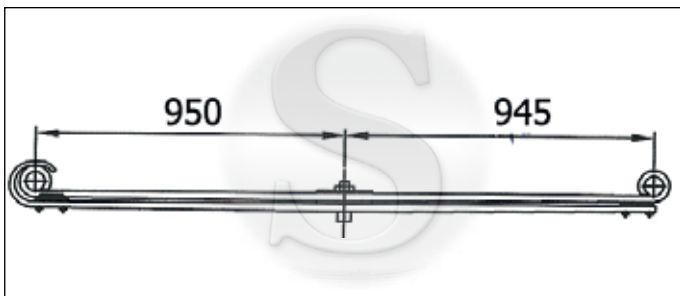

CODE	TYPE	LEA- VES	MATERIAL SIZE	LENGTH		EYE	
				F	R	F	R
5070160		2		950 - 945			
5070161			90x29				
5070162			90x29				

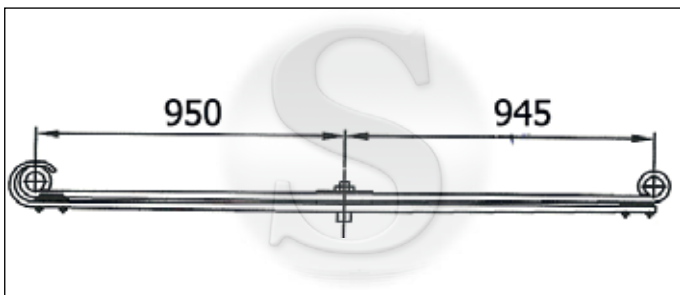

CODE	TYPE	LEA- VES	MATERIAL SIZE	LENGTH		EYE	
				F	R	F	R
5072220		2		950 - 945			
5072221			90x29				
5072222			90x29				

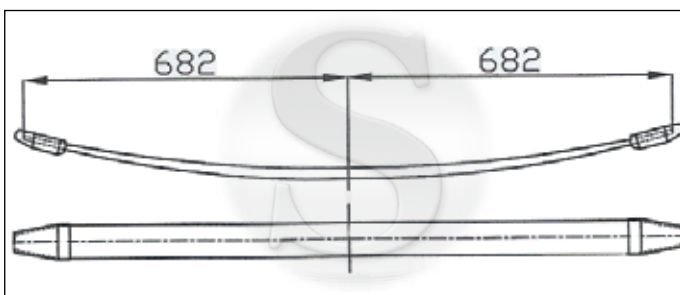

CODE	TYPE	LEA- VES	MATERIAL SIZE	LENGTH		EYE	
				F	R	F	R
5070230		1	80x20	682 - 682			

Any reference to manufacture' s numbers are for the comparison purpose only. Alle Hersteller-Referenzen dien nur zu Vergleichswecken. Les references constructeur servent uniquement atitre d' indetification

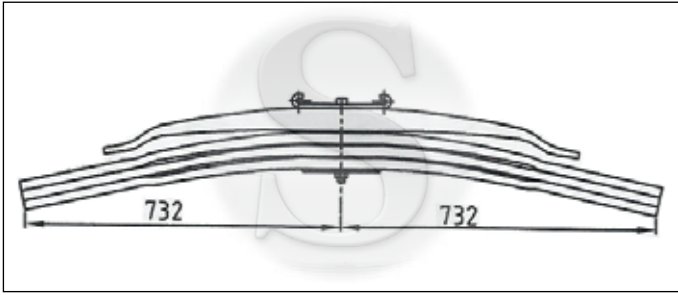

CODE	TYPE	LEAVES	MATERIAL SIZE	LENGTH		EYE	
				F	R	F	R
5070200		4		732 - 732			
5070201			100x26				
5070202			100x26				
5070203			100x26				
5070204			100x43				

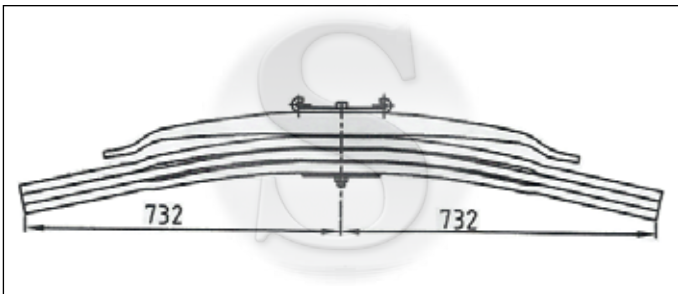

CODE	TYPE	LEAVES	MATERIAL SIZE	LENGTH		EYE	
				F	R	F	R
5070400		4		732 - 732			
5070401			100x26				
5070402			100x26				
5070403			100x26				
5070404			100x53				

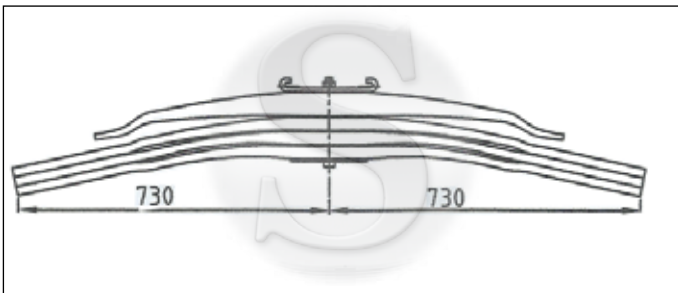

CODE	TYPE	LEAVES	MATERIAL SIZE	LENGTH		EYE	
				F	R	F	R
5070170		4		730 - 730			
5070171			100x31				
5070172			100x31				
5070173			100x31				
5070174			100x56				

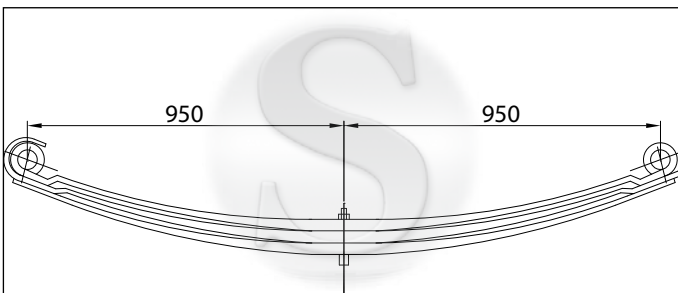

CODE	TYPE	LEAVES	MATERIAL SIZE	LENGTH		EYE	
				F	R	F	R
5070140		3		950 - 950			
5070141			90x25				
5070142			90x26				
5070143			90x26				

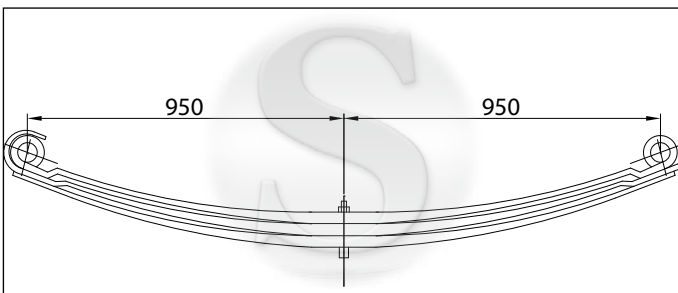

CODE	TYPE	LEAVES	MATERIAL SIZE	LENGTH		EYE	
				F	R	F	R
5070150		3		760 - 760			
5070151			90x25				
5070152			90x25				
5070153			90x25				

Any reference to manufacture' s numbers are for the comparison purpose only. Alle Hersteller-Referenzen dien nur zu Vergleichswecken. Les references constructeur servent uniquement atitre d' indetification

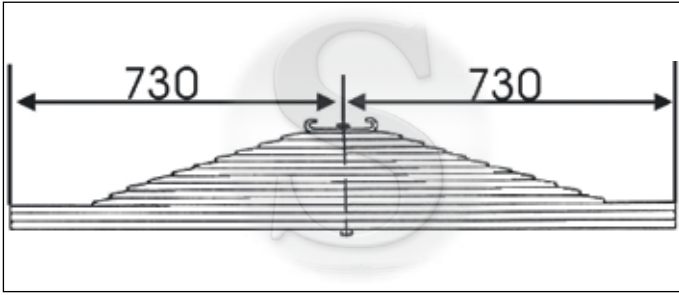

CODE	TYPE	LEA- VES	MATERIAL SIZE	LENGTH		EYE	
				F	R	F	R
6070120		13	100x22	730 - 730			

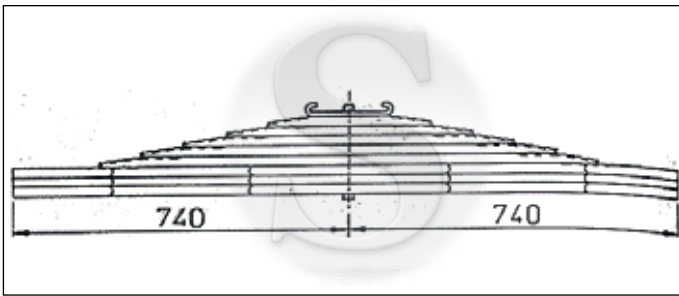

CODE	TYPE	LEA- VES	MATERIAL SIZE	LENGTH		EYE	
				F	R	F	R
6070130		8	100x22	740 - 740			

Any reference to manufacture' s numbers are for the comparison purpose only. Alle Hersteller-Referenzen dien nur zu Vergleichswecken. Les references constructeur servent uniquement atitre d' indetification

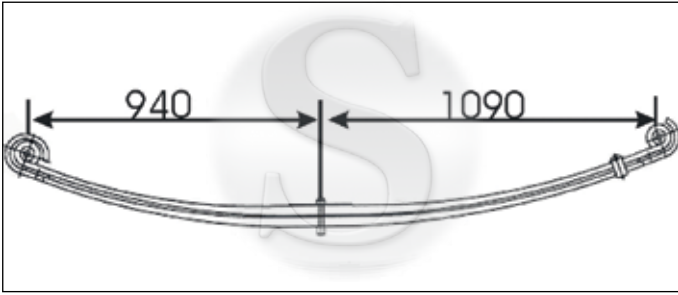

CODE	TYPE	LEAVES	MATERIAL SIZE	LENGTH		EYE	
				F	R	F	R
5075100		2		940 - 1090			
5075101	PREMIUM		90x32				
5075102	I, II		90x32				
	MAGNUM						
	420						

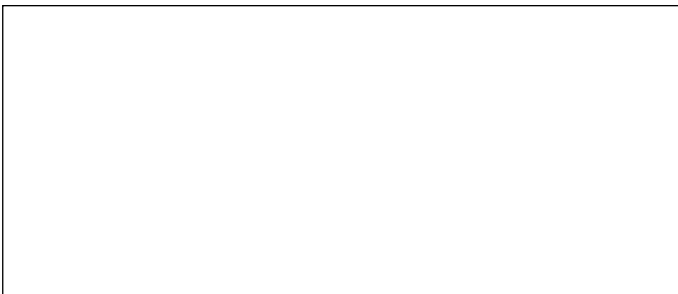

CODE	TYPE	LEAVES	MATERIAL SIZE	LENGTH		EYE	
				F	R	F	R
5075600		3		820 - 820			
5075601			90x23				
5075602			90x23				
5075603			90x23				

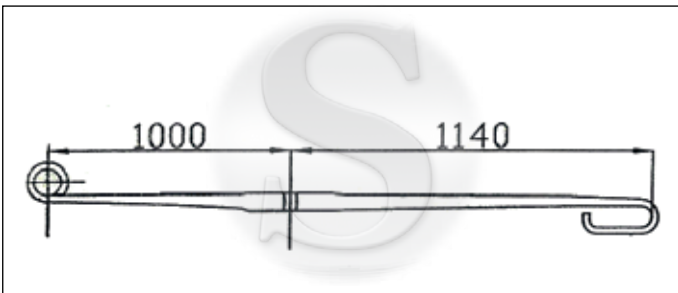

CODE	TYPE	LEAVES	MATERIAL SIZE	LENGTH		EYE	
				F	R	F	R
5075300		1	80x38	1000 - 1140			

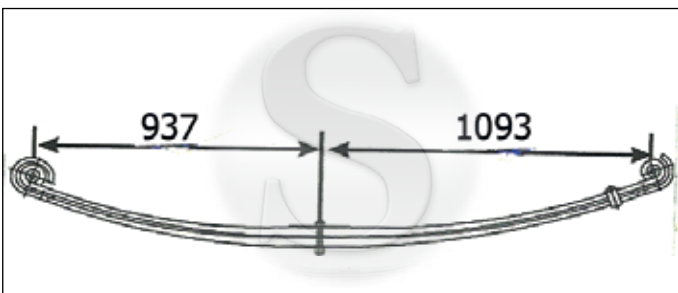

CODE	TYPE	LEAVES	MATERIAL SIZE	LENGTH		EYE	
				F	R	F	R
5075800	PREMIUM I, II	2		937 - 1093			
5075801	MAGNUMAE		90x30				
5075802	E-TECH		90x30				

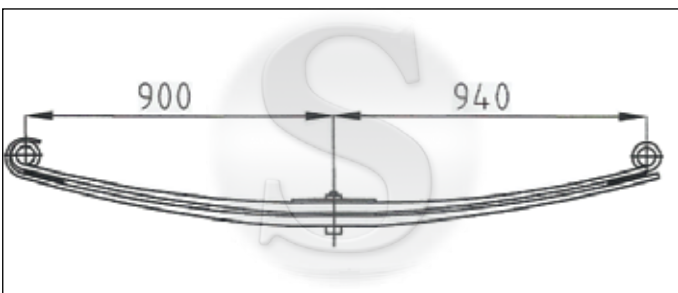

CODE	TYPE	LEAVES	MATERIAL SIZE	LENGTH		EYE	
				F	R	F	R
5075900	KERAX I	2		900 - 940			
5075901	KERAX II		90x30				
5075902			90x30				

Any reference to manufacture' s numbers are for the comparison purpose only. Alle Hersteller-Referenzen dien nur zu Vergleichswecken. Les references constructeur servent uniquement atitre d' indetification

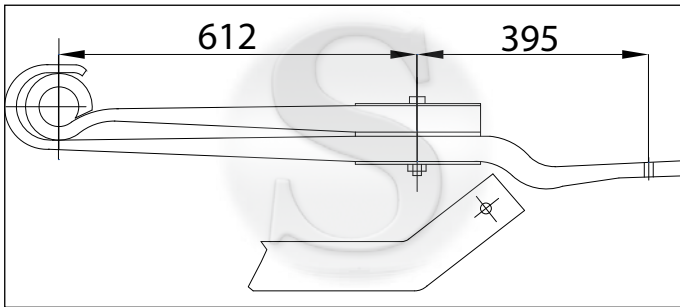

CODE	TYPE	LEAVES	MATERIAL SIZE	LENGTH		EYE	
				F	R	F	R
5075400	PREMIUM I	2		612 - 395			
5075401	PREMIUM II		100x46				
5075402	KERAX I		100x46				
	KERAX II						
	MAGNUMAE						

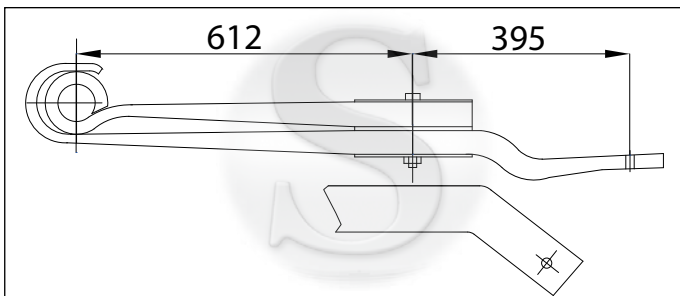

CODE	TYPE	LEAVES	MATERIAL SIZE	LENGTH		EYE	
				F	R	F	R
5075500	PREMIUM I	2		612 - 395			
5075501	PREMIUM II		100x46				
5075502	KERAX I		100x46				
	KERAX II						
	MAGNUMAE						

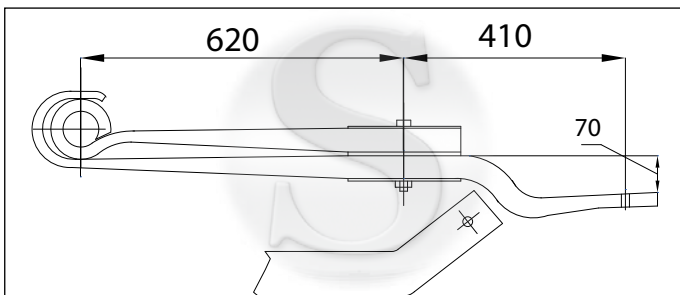

CODE	TYPE	LEAVES	MATERIAL SIZE	LENGTH		EYE	
				F	R	F	R
5075940		2		620 - 410			
			90x48				
			90x48				

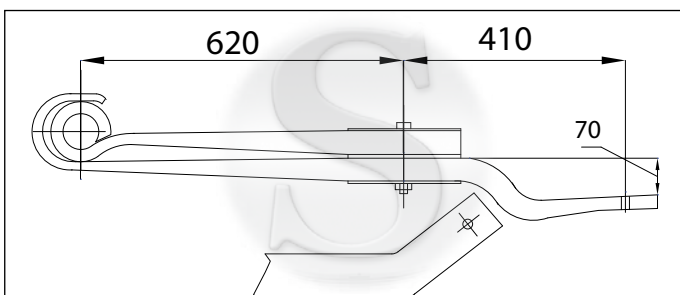

CODE	TYPE	LEAVES	MATERIAL SIZE	LENGTH		EYE	
				F	R	F	R
5075950		2		620 - 410			
			90x48				
			90x48				

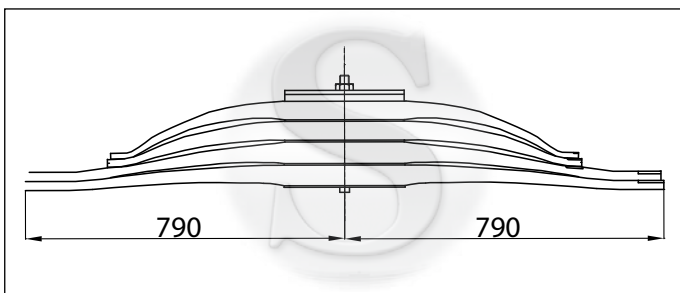

CODE	TYPE	LEAVES	MATERIAL SIZE	LENGTH		EYE	
				F	R	F	R
5075700	KERAX I	4		790 - 790			
5075701	KERAX II		100x51				
5075702			100x51				
5075703			100x47				
5075704			100x47				

Any reference to manufacture' s numbers are for the comparison purpose only. Alle Hersteller-Referenzen dien nur zu Vergleichswecken. Les references constructeur servent uniquement atitre d' indetification

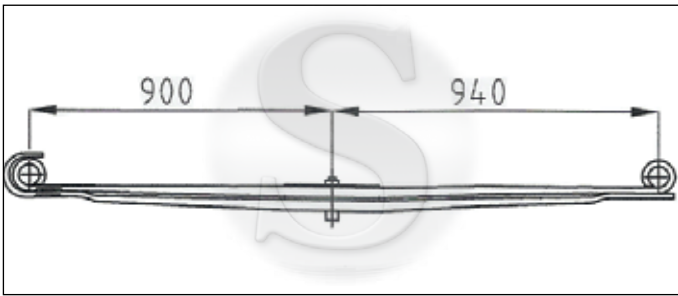

CODE	TYPE	LEAVES	MATERIAL SIZE	LENGTH		EYE	
				F	R	F	R
5075310	PREMIUM II	2		900 - 940			
	PREMIUM III		90x35				
	KERAX III		90x35				

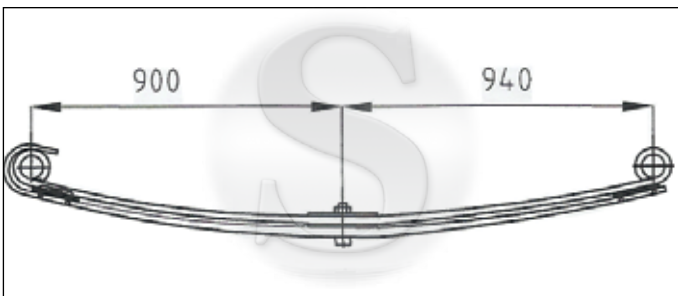

CODE	TYPE	LEAVES	MATERIAL SIZE	LENGTH		EYE	
				F	R	F	R
5075320	MIDLUM I	2	90x28	900 - 940			

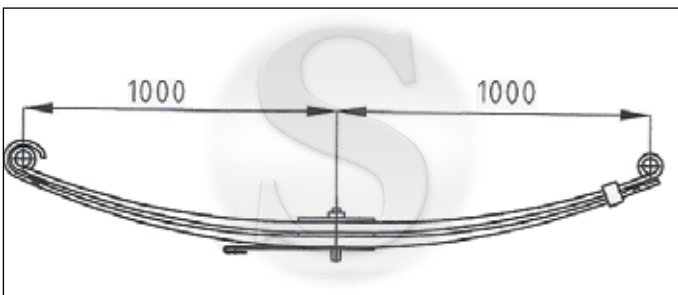

CODE	TYPE	LEAVES	MATERIAL SIZE	LENGTH		EYE	
				F	R	F	R
5075330	MIDLUM I	2		1000 - 1000			
			80x30				
			80x30				

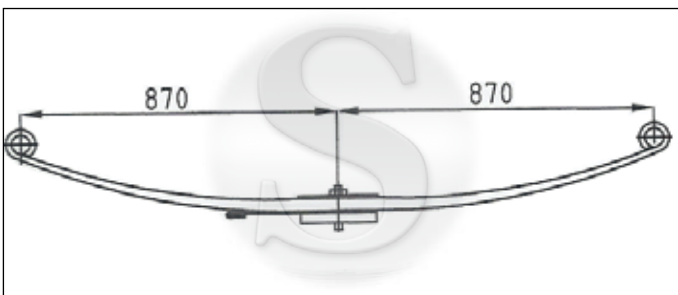

CODE	TYPE	LEAVES	MATERIAL SIZE	LENGTH		EYE	
				F	R	F	R
5075210	MIDLUM I	1	70x30	870 - 870			
	MIDLUM II						

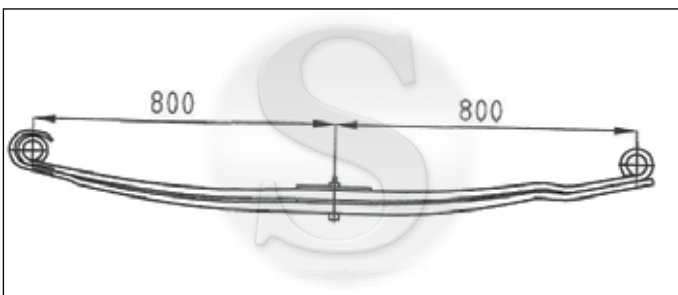

CODE	TYPE	LEAVES	MATERIAL SIZE	LENGTH		EYE	
				F	R	F	R
5075220	MIDLUM I	2		800 - 800			
	MIDLUM II		70x30				
			70x30				

Any reference to manufacture' s numbers are for the comparison purpose only. Alle Hersteller-Referenzen dien nur zu Vergleichswecken. Les references constructeur servent uniquement atitre d' indetification

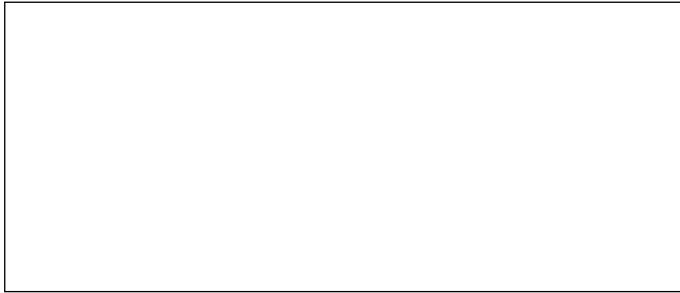

CODE	TYPE	LEA- VES	MATERIAL SIZE	LENGTH		EYE	
				F	R	F	R
5066410		3		800 - 800			
5066411			90x26				
5066412			90x26				
5066413			90x26				

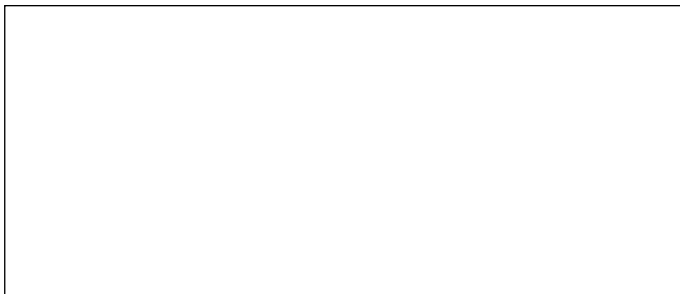

CODE	TYPE	LEA- VES	MATERIAL SIZE	LENGTH		EYE	
				F	R	F	R
5066420		4		815 - 815			
5066421			100x40				
5066422			100x40				
5066423			100x40				
5066424			100x40				

Any reference to manufacture' s numbers are for the comparison purpose only. Alle Hersteller-Referenzen dien nur zu Vergleichswecken. Les references constructeur servent uniquement atitre d' indetification

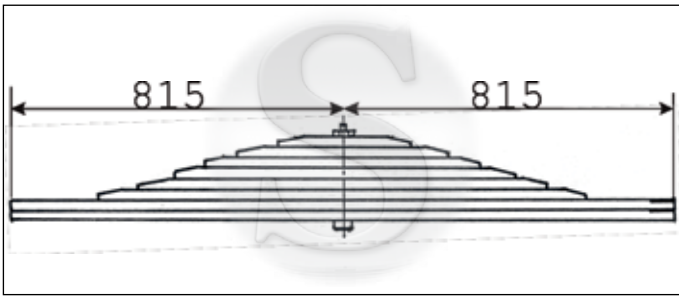

CODE	TYPE	LEA- VES	MATERIAL SIZE	LENGTH		EYE	
				F	R	F	R
6200000		8	100x25	815	815		

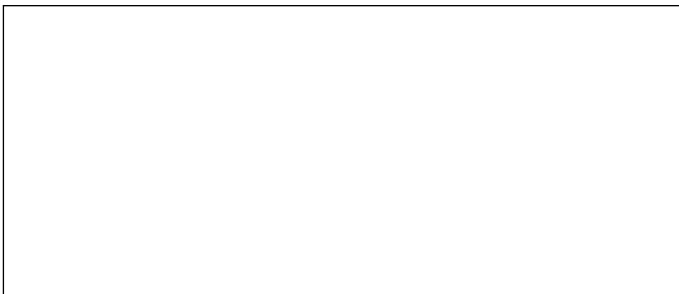

CODE	TYPE	LEA- VES	MATERIAL SIZE	LENGTH		EYE	
				F	R	F	R
6200100		9	100x25	815	815		

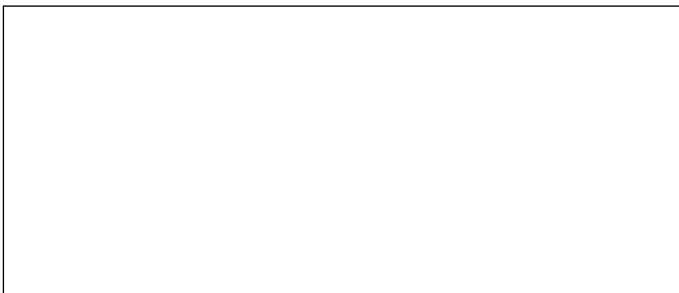

CODE	TYPE	LEA- VES	MATERIAL SIZE	LENGTH		EYE	
				F	R	F	R
6200200		10	100x25	815	815		

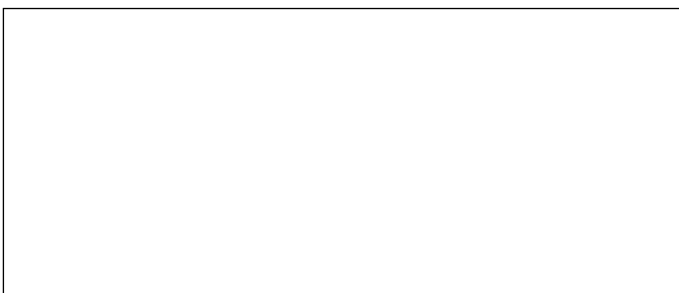

CODE	TYPE	LEA- VES	MATERIAL SIZE	LENGTH		EYE	
				F	R	F	R
6200300		8	90x16	800	792		

Any reference to manufacture' s numbers are for the comparison purpose only. Alle Hersteller-Referenzen dien nur zu Vergleichswecken. Les references constructeur servent uniquement atitre d' indetification

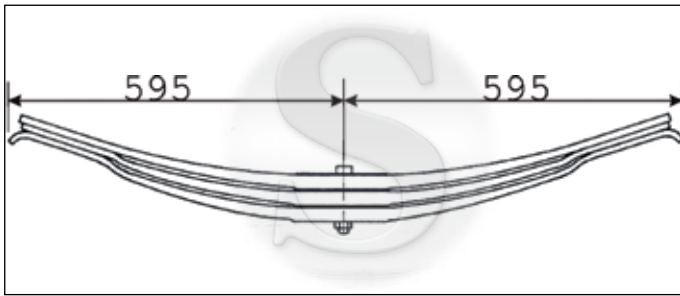

CODE	TYPE	LEA- VES	MATERIAL SIZE	LENGTH		EYE	
				F	R	F	R
5750000		3	100x19	595	595		

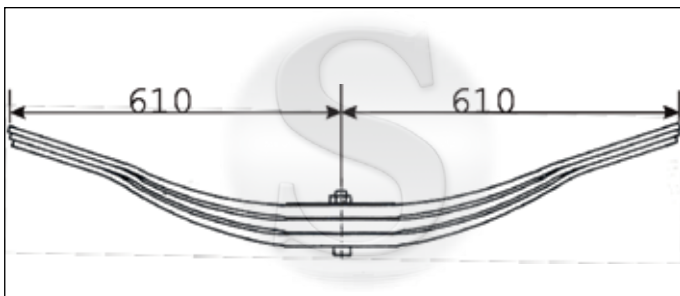

CODE	TYPE	LEA- VES	MATERIAL SIZE	LENGTH		EYE	
				F	R	F	R
5720000		3	100x19	610	610		

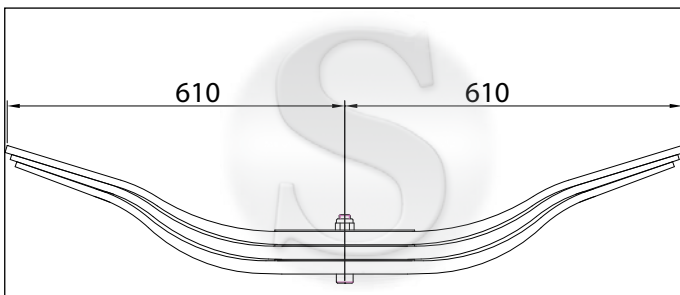

CODE	TYPE	LEA- VES	MATERIAL SIZE	LENGTH		EYE	
				F	R	F	R
5103400		3	100x22	610	610		

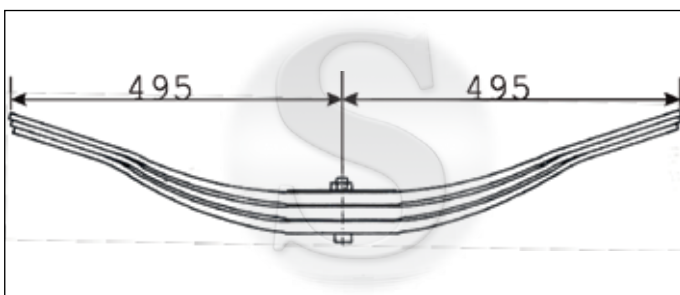

CODE	TYPE	LEA- VES	MATERIAL SIZE	LENGTH		EYE	
				F	R	F	R
5790000		3	100x18	495	495		

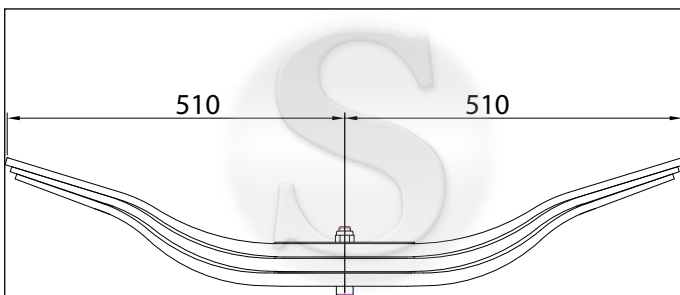

CODE	TYPE	LEA- VES	MATERIAL SIZE	LENGTH		EYE	
				F	R	F	R
5103100		3	100x19	510	510		

Any reference to manufacture' s numbers are for the comparison purpose only. Alle Hersteller-Referenzen dien nur zu Vergleichswecken. Les references constructeur servent uniquement atitre d' indetification

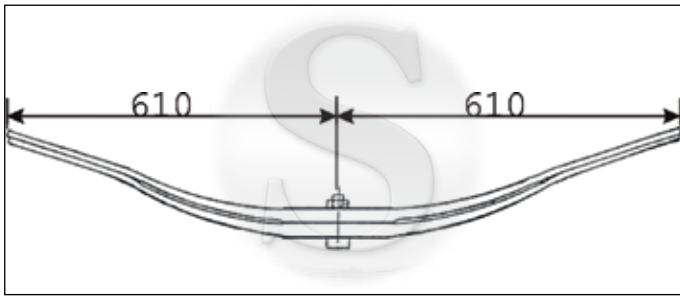

CODE	TYPE	LEA- VES	MATERIAL SIZE	LENGTH		EYE	
				F	R	F	R
5730000		2	100x27	610	610		

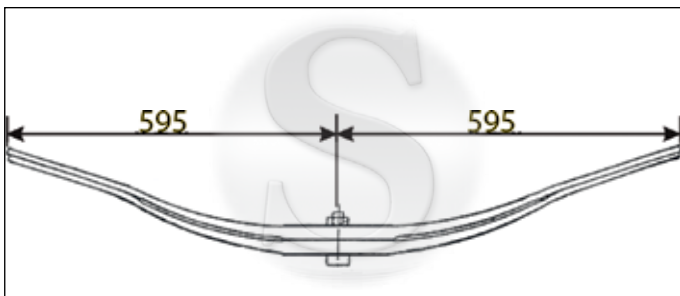

CODE	TYPE	LEA- VES	MATERIAL SIZE	LENGTH		EYE	
				F	R	F	R
5103900		2	100x27	595	595		

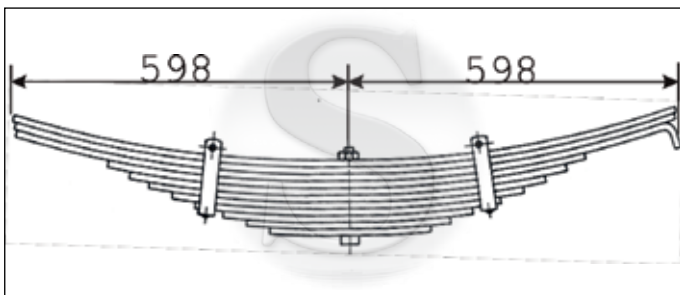

CODE	TYPE	LEA- VES	MATERIAL SIZE	LENGTH		EYE	
				F	R	F	R
6940000		13	100x10	598	598		

Any reference to manufacture' s numbers are for the comparison purpose only. Alle Hersteller-Referenzen dien nur zu Vergleichswecken. Les references constructeur servent uniquement atitre d' indetification

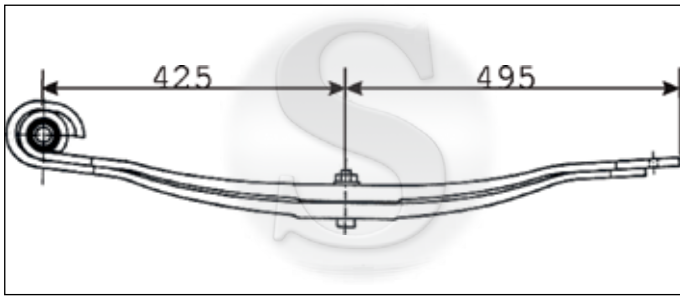

CODE	TYPE	LEAVES	MATERIAL SIZE	LENGTH		EYE	
				F	R	F	R
5782000		2	100x24	425	495		

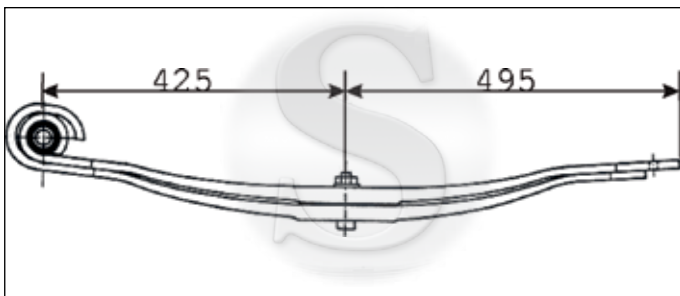

CODE	TYPE	LEAVES	MATERIAL SIZE	LENGTH		EYE	
				F	R	F	R
5781000		2	100x26	425	495		

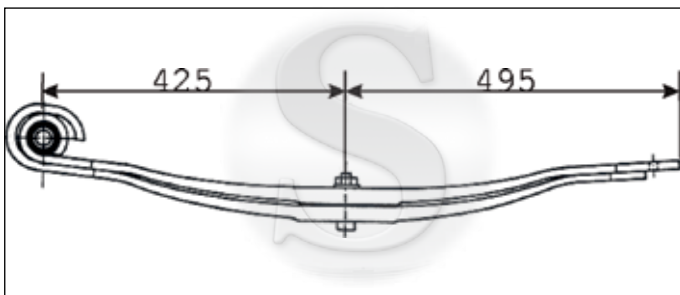

CODE	TYPE	LEAVES	MATERIAL SIZE	LENGTH		EYE	
				F	R	F	R
5780000		2	100x32	425	495		

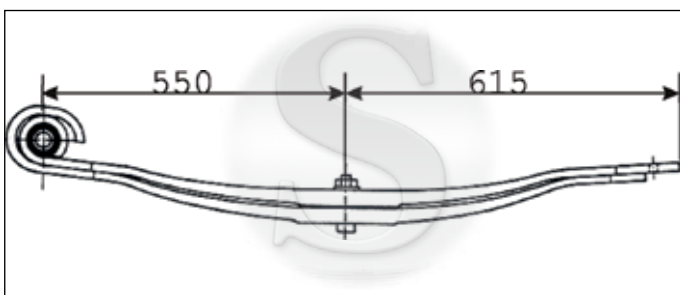

CODE	TYPE	LEAVES	MATERIAL SIZE	LENGTH		EYE	
				F	R	F	R
5870000		2	100x30	550	615		

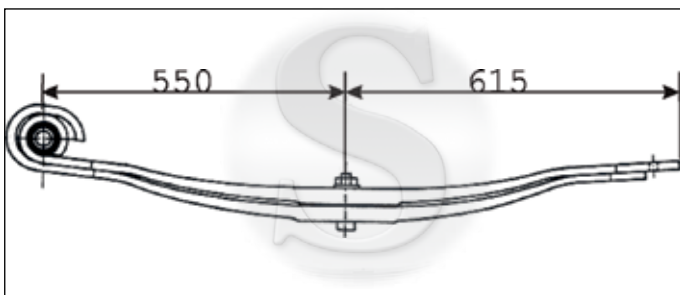

CODE	TYPE	LEAVES	MATERIAL SIZE	LENGTH		EYE	
				F	R	F	R
5103000		2	100x33	550	615		

Any reference to manufacture' s numbers are for the comparison purpose only. Alle Hersteller-Referenzen dien nur zu Vergleichswecken. Les references constructeur servent uniquement atitre d' indetification

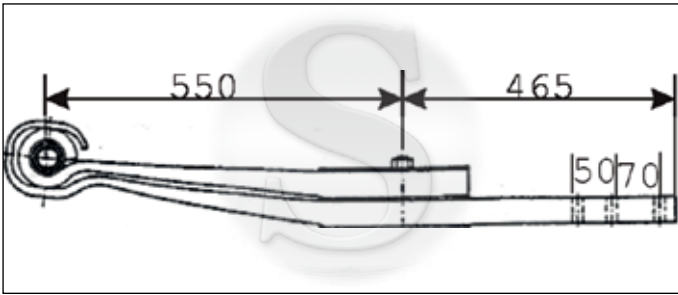

CODE	TYPE	LEA- VES	MATERIAL SIZE	LENGTH		EYE	
				F	R	F	R
5102400		2		550 - 465			
5102401			100x40				
5102402			100x40				

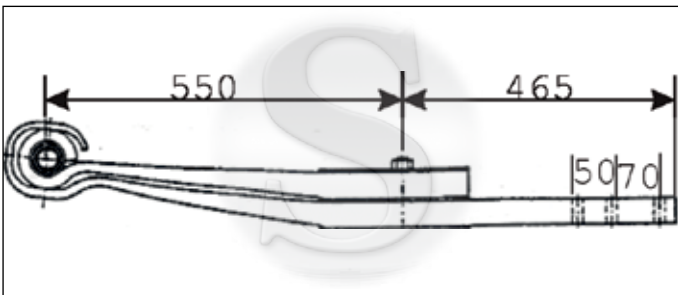

CODE	TYPE	LEA- VES	MATERIAL SIZE	LENGTH		EYE	
				F	R	F	R
5770000		2		550 - 465			
5770001			100x40				
5770002			100x40				

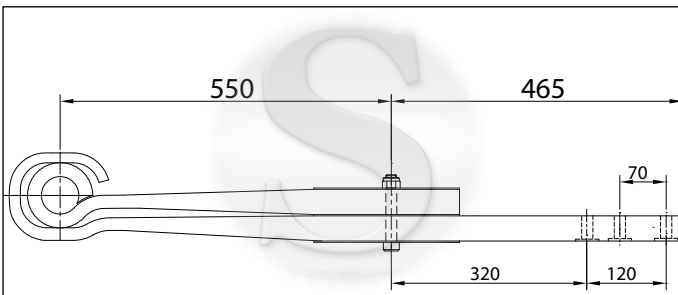

CODE	TYPE	LEA- VES	MATERIAL SIZE	LENGTH		EYE	
				F	R	F	R
5771000		2		550 - 465			
5771001			100x40				
5771002			100x40				

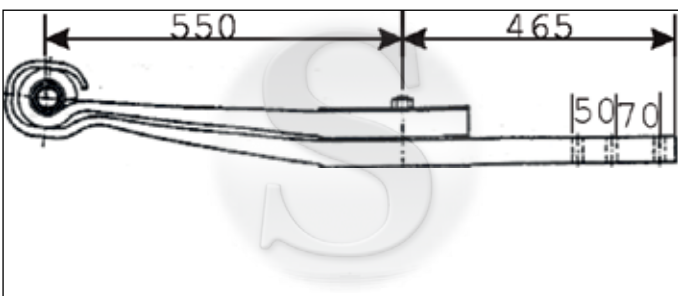

CODE	TYPE	LEA- VES	MATERIAL SIZE	LENGTH		EYE	
				F	R	F	R
5772000		2		550 - 465			
5772001			100x43				
5772002			100x43				

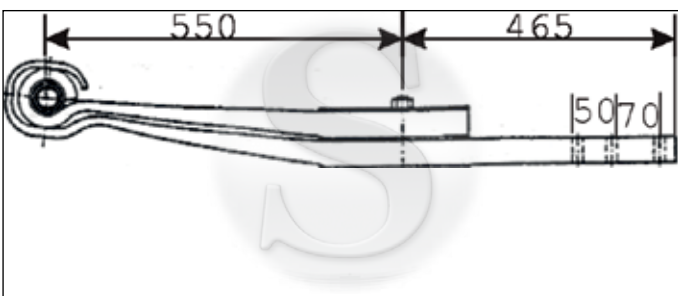

CODE	TYPE	LEA- VES	MATERIAL SIZE	LENGTH		EYE	
				F	R	F	R
5773000		2		550 - 465			
5773001			100x43				
5773002			100x43				

Any reference to manufacture' s numbers are for the comparison purpose only. Alle Hersteller-Referenzen dien nur zu Vergleichswecken. Les references constructeur servent uniquement atitre d' indetification

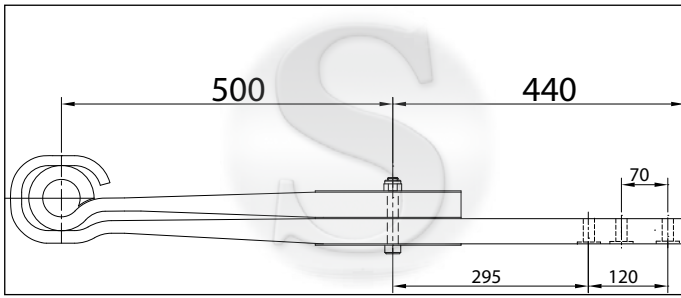

CODE	TYPE	LEAVES	MATERIAL SIZE	LENGTH		EYE	
				F	R	F	R
5102500		2		500 - 440			
5102501			100x33				
5102502			100x33				

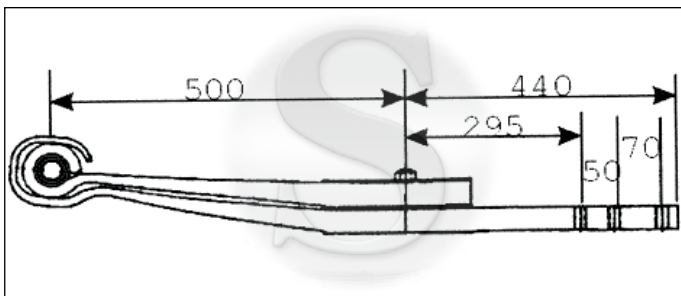

CODE	TYPE	LEAVES	MATERIAL SIZE	LENGTH		EYE	
				F	R	F	R
5778000		2		500 - 440			
5778001			100x38				
5778002			100x38				

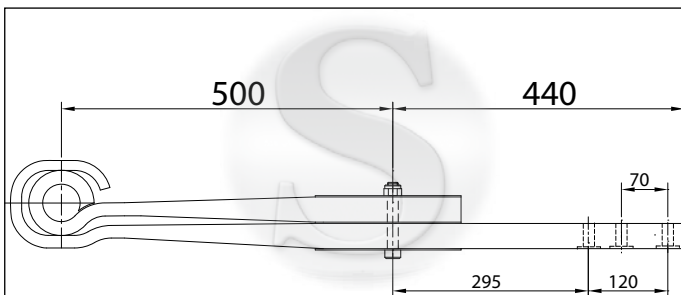

CODE	TYPE	LEAVES	MATERIAL SIZE	LENGTH		EYE	
				F	R	F	R
5100900		2		500 - 440			
5100901			100x38				
5100902			100x38				

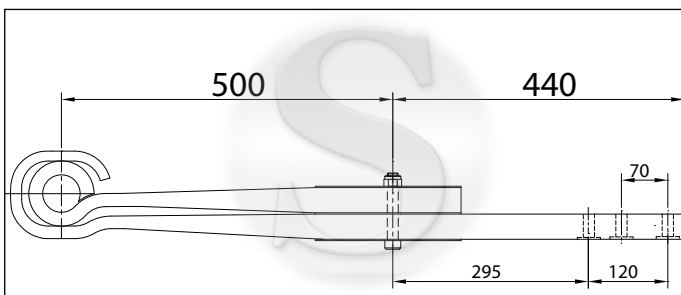

CODE	TYPE	LEAVES	MATERIAL SIZE	LENGTH		EYE	
				F	R	F	R
5103300		2		500 - 440			
5103301			100x38				
5103302			100x38				

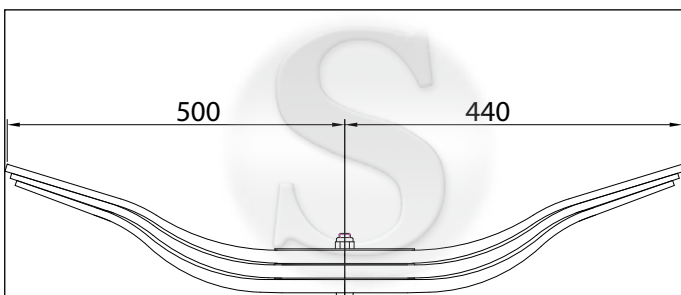

CODE	TYPE	LEAVES	MATERIAL SIZE	LENGTH		EYE	
				F	R	F	R
5779000		2		500 - 440			
5779001			100x38				
5779002			100x38				

Any reference to manufacture' s numbers are for the comparison purpose only. Alle Hersteller-Referenzen dien nur zu Vergleichswecken. Les references constructeur servent uniquement atitre d' indetification

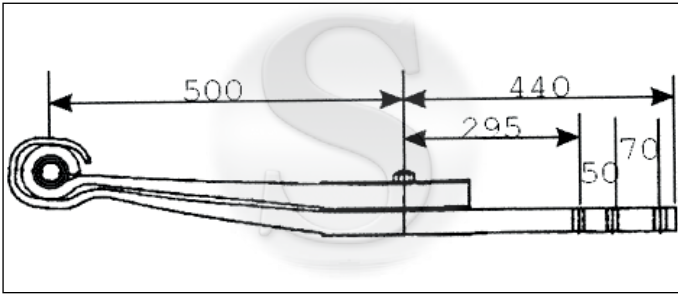

CODE	TYPE	LEA- VES	MATERIAL SIZE	LENGTH		EYE	
				F	R	F	R
5778100		2		500 - 440			
5778101			100x43				
5778102			100x43				

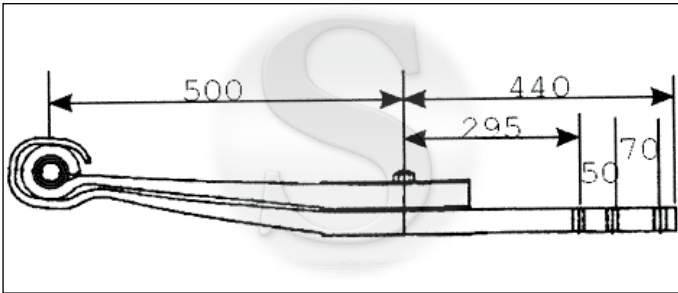

CODE	TYPE	LEA- VES	MATERIAL SIZE	LENGTH		EYE	
				F	R	F	R
5778300		2		500 - 440			
5778301			100x43				
5778302			100x43				

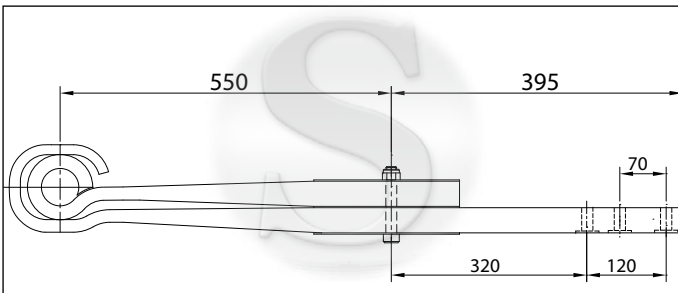

CODE	TYPE	LEA- VES	MATERIAL SIZE	LENGTH		EYE	
				F	R	F	R
5778700		2		550 - 395			
5778701			100x40				
5778702			100x40				

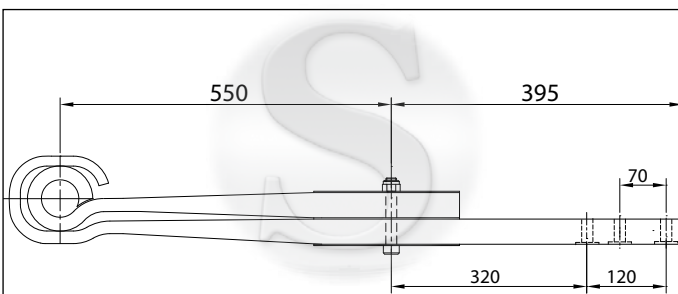

CODE	TYPE	LEA- VES	MATERIAL SIZE	LENGTH		EYE	
				F	R	F	R
5778800		2		550 - 395			
5778801			100x33				
5778802			100x33				

Any reference to manufacture' s numbers are for the comparison purpose only. Alle Hersteller-Referenzen dien nur zu Vergleichswecken. Les references constructeur servent uniquement atitre d' indetification

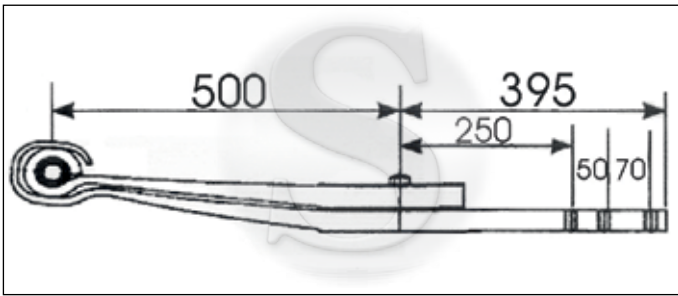

CODE	TYPE	LEA- VES	MATERIAL SIZE	LENGTH		EYE	
				F	R	F	R
5721900		2		500 - 395			
5721901			100x33				
5721902			100x33				

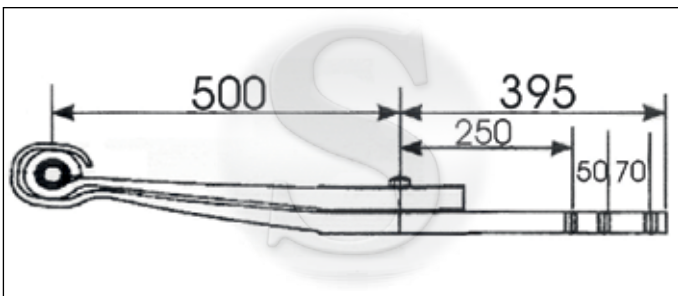

CODE	TYPE	LEA- VES	MATERIAL SIZE	LENGTH		EYE	
				F	R	F	R
5721200				500 - 395			
5721201			100x33				
5721202			100x33				

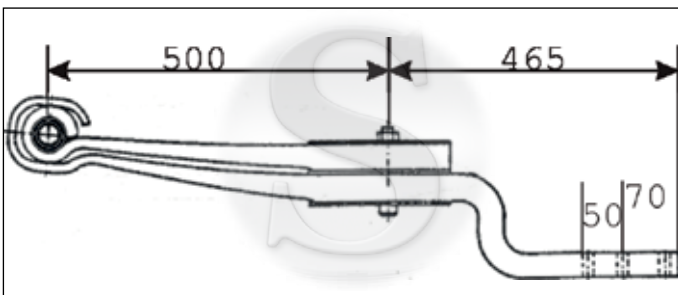

CODE	TYPE	LEA- VES	MATERIAL SIZE	LENGTH		EYE	
				F	R	F	R
5103600		2		500 - 465			
			100x38				
			100x38				

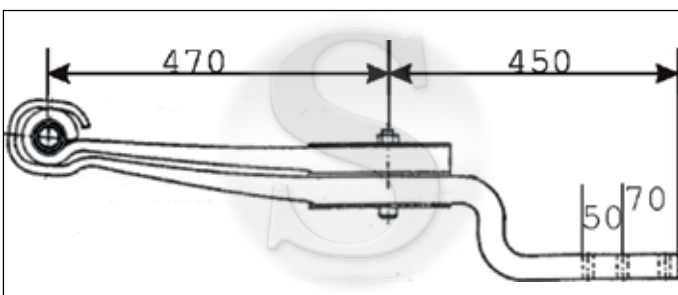

CODE	TYPE	LEA- VES	MATERIAL SIZE	LENGTH		EYE	
				F	R	F	R
5105000		2		470 - 450			
5105001			100x33				
5105002			100x33				

Any reference to manufacture' s numbers are for the comparison purpose only. Alle Hersteller-Referenzen dien nur zu Vergleichswecken. Les references constructeur servent uniquement atitre d' indetification

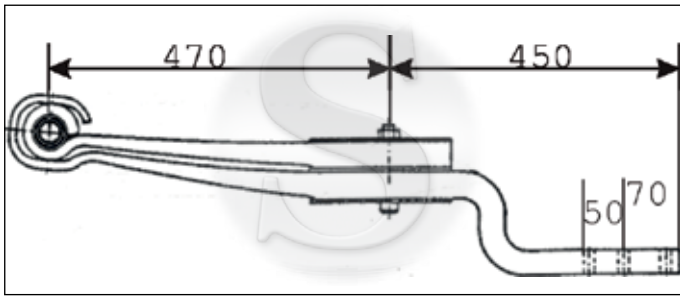

CODE	TYPE	LEA- VES	MATERIAL SIZE	LENGTH		EYE	
				F	R	F	R
5102600		2		470 - 450			
5102601			100x38				
5102602			100x38				

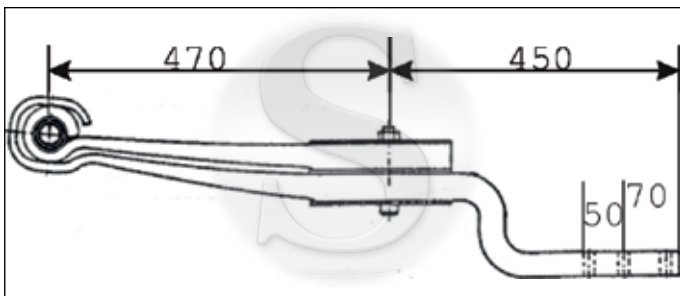

CODE	TYPE	LEA- VES	MATERIAL SIZE	LENGTH		EYE	
				F	R	F	R
5100700		2		470 - 450			
5100701			100x38				
5100702			100x38				

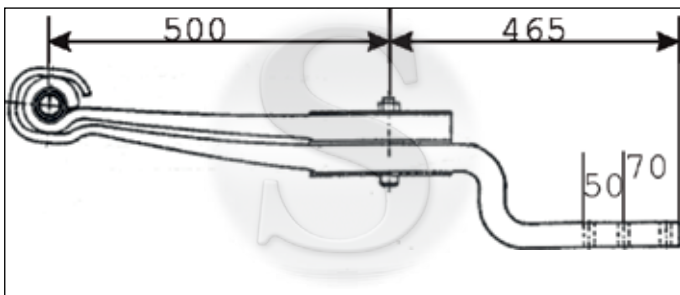

CODE	TYPE	LEA- VES	MATERIAL SIZE	LENGTH		EYE	
				F	R	F	R
5900000		2		500 - 465			
5900001			100x38				
5900002			100x38				

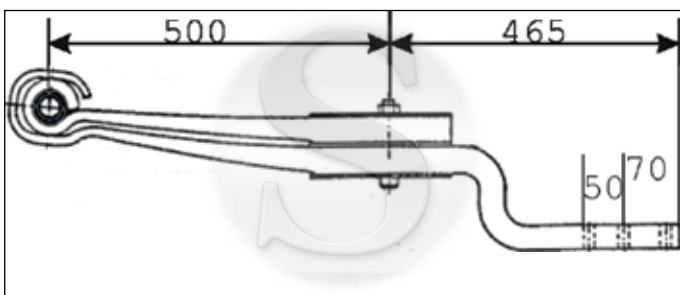

CODE	TYPE	LEA- VES	MATERIAL SIZE	LENGTH		EYE	
				F	R	F	R
5721800		2		500 - 465			
5721801			100x43				
5721802			100x43				

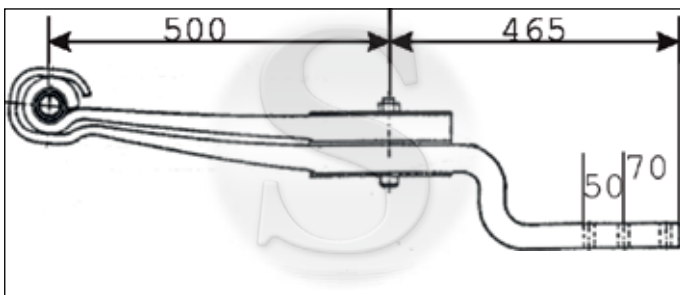

CODE	TYPE	LEA- VES	MATERIAL SIZE	LENGTH		EYE	
				F	R	F	R
5721700		2		500 - 465			
5721701			100x33				
5721702			100x33				

Any reference to manufacture' s numbers are for the comparison purpose only. Alle Hersteller-Referenzen dien nur zu Vergleichswecken. Les references constructeur servent uniquement atitre d' indetification

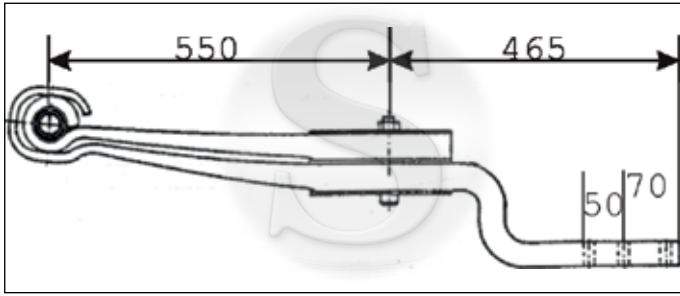

CODE	TYPE	LEA- VES	MATERIAL SIZE	LENGTH		EYE	
				F	R	F	R
5762000		2		550 - 465			
5762001			100x40				
5762002			100x40				

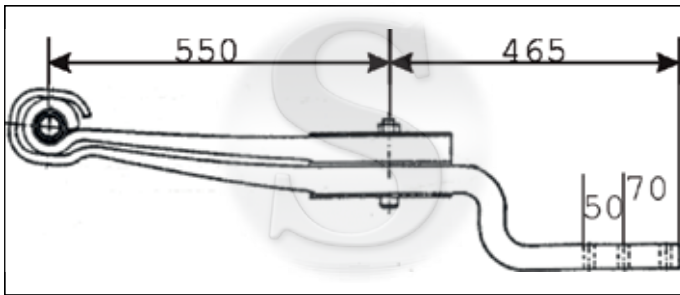

CODE	TYPE	LEA- VES	MATERIAL SIZE	LENGTH		EYE	
				F	R	F	R
5763000		2		550 - 465			
5763001			100x40				
5763002			100x40				

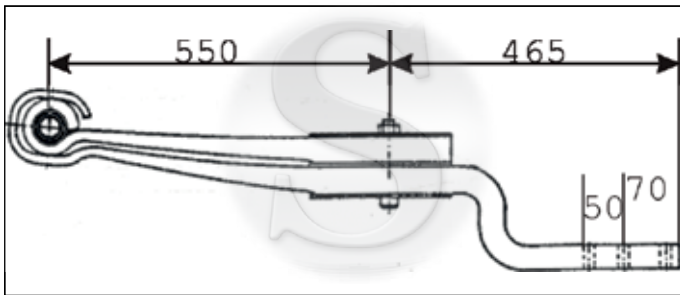

CODE	TYPE	LEA- VES	MATERIAL SIZE	LENGTH		EYE	
				F	R	F	R
5760000		2		550 - 465			
5760001			100x40				
5760002			100x40				

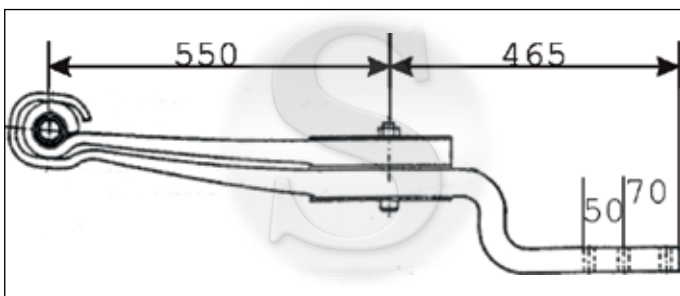

CODE	TYPE	LEA- VES	MATERIAL SIZE	LENGTH		EYE	
				F	R	F	R
5761000		2		550 - 465			
5761001			100x40				
5761002			100x40				

Any reference to manufacture' s numbers are for the comparison purpose only. Alle Hersteller-Referenzen dien nur zu Vergleichswecken. Les references constructeur servent uniquement atitre d' indetification

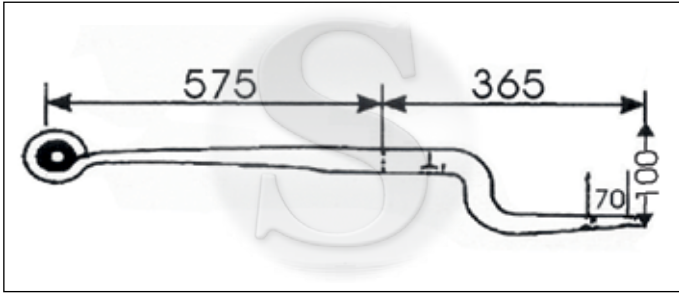

CODE	TYPE	LEAVES	MATERIAL SIZE	LENGTH		EYE	
				F	R	F	R
5721100		1	100x48	575	365		

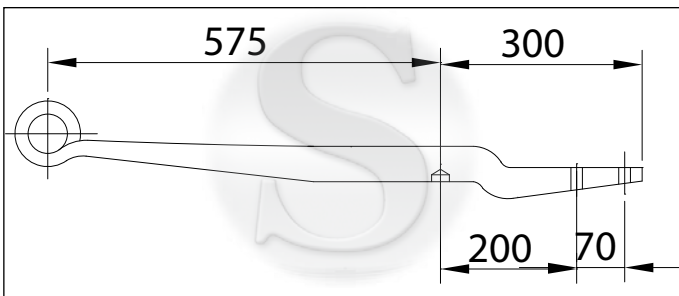

CODE	TYPE	LEAVES	MATERIAL SIZE	LENGTH		EYE	
				F	R	F	R
5101900		1	100x48	575	295		

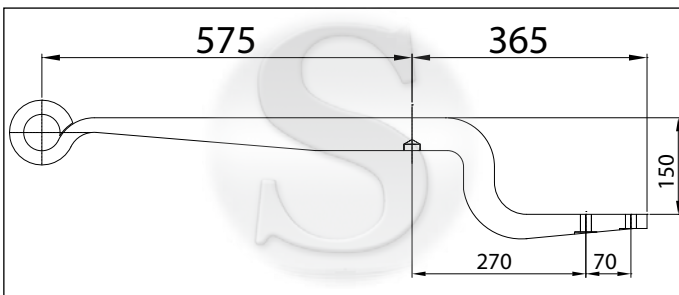

CODE	TYPE	LEAVES	MATERIAL SIZE	LENGTH		EYE	
				F	R	F	R
5103200		1	100x48	575	365		

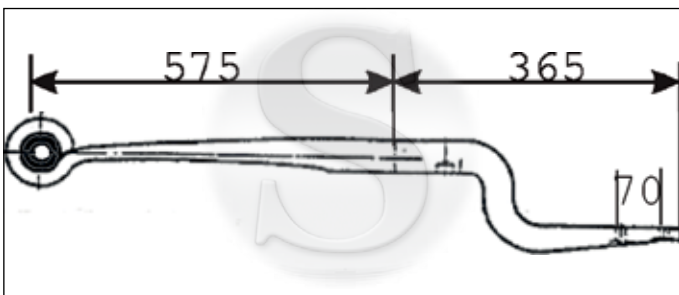

CODE	TYPE	LEAVES	MATERIAL SIZE	LENGTH		EYE	
				F	R	F	R
5101000		1	100x51	575	365		

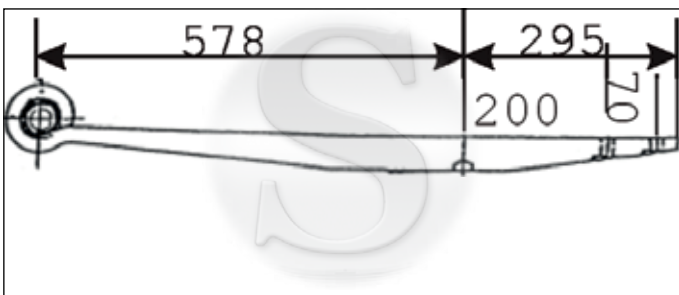

CODE	TYPE	LEAVES	MATERIAL SIZE	LENGTH		EYE	
				F	R	F	R
5101600		1	100x48	578	295		

Any reference to manufacture' s numbers are for the comparison purpose only. Alle Hersteller-Referenzen dien nur zu Vergleichswecken. Les references constructeur servent uniquement atitre d' indetification

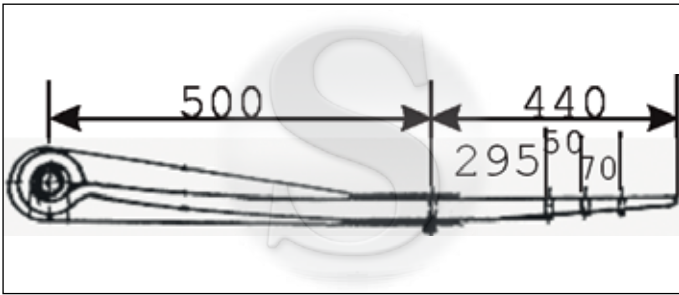

CODE	TYPE	LEA- VES	MATERIAL SIZE	LENGTH		EYE	
				F	R	F	R
5101400		1	100x48	500	440		

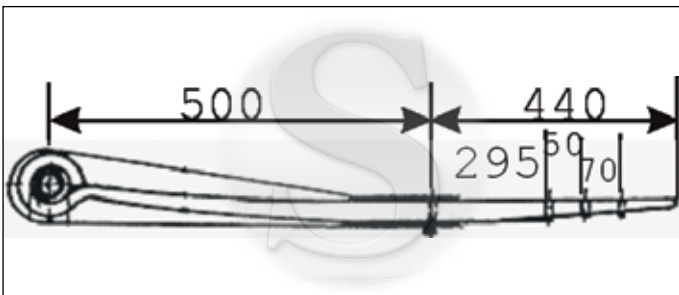

CODE	TYPE	LEA- VES	MATERIAL SIZE	LENGTH		EYE	
				F	R	F	R
5101500		1	100x48	500	440		

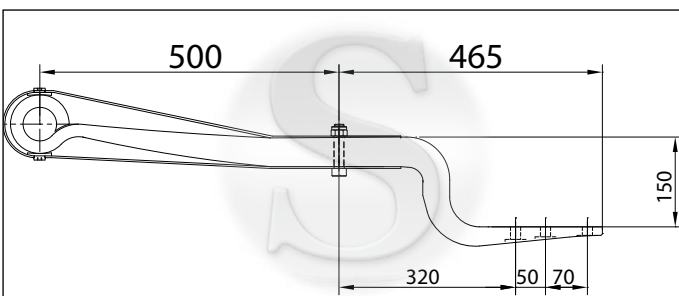

CODE	TYPE	LEA- VES	MATERIAL SIZE	LENGTH		EYE	
				F	R	F	R
5100000		1	100x48	500	465		

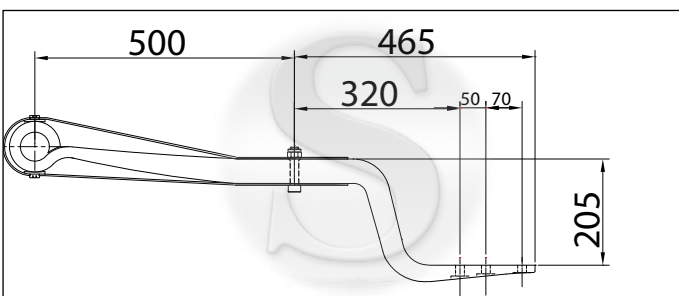

CODE	TYPE	LEA- VES	MATERIAL SIZE	LENGTH		EYE	
				F	R	F	R
5100100		1	100x48	500	465		

Any reference to manufacture' s numbers are for the comparison purpose only. Alle Hersteller-Referenzen dien nur zu Vergleichswecken. Les references constructeur servent uniquement atitre d' indetification

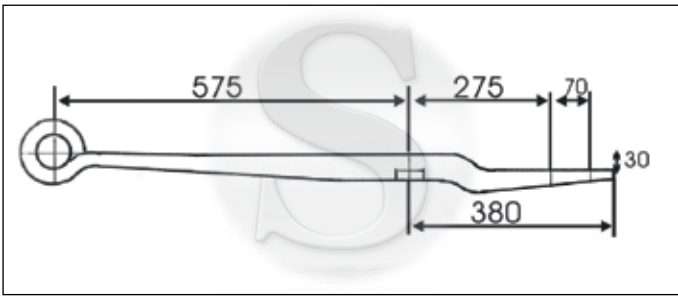

CODE	TYPE	LEA- VES	MATERIAL SIZE	LENGTH		EYE	
				F	R	F	R
5721400		1	70x56	575	380		

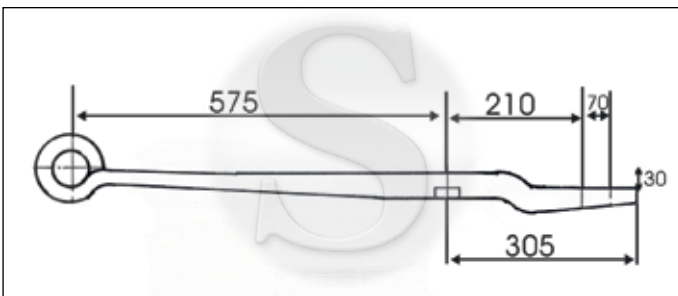

CODE	TYPE	LEA- VES	MATERIAL SIZE	LENGTH		EYE	
				F	R	F	R
5721500		1	70x56	575	305		

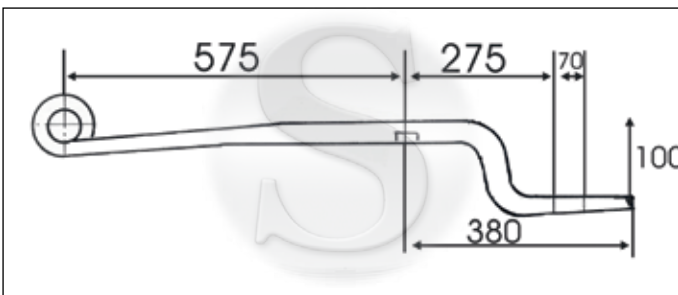

CODE	TYPE	LEA- VES	MATERIAL SIZE	LENGTH		EYE	
				F	R	F	R
5721600		1	70x56	575	380		

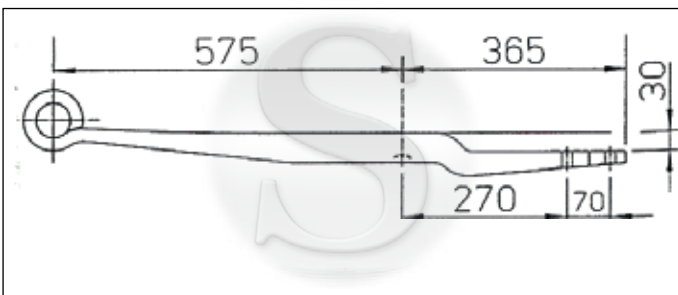

CODE	TYPE	LEA- VES	MATERIAL SIZE	LENGTH		EYE	
				F	R	F	R
5730100		1	100x51	575	365		

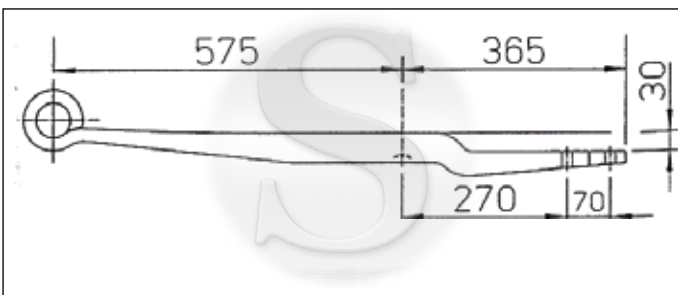

CODE	TYPE	LEA- VES	MATERIAL SIZE	LENGTH		EYE	
				F	R	F	R
5730200		1	100x48	575	365		

Any reference to manufacture' s numbers are for the comparison purpose only. Alle Hersteller-Referenzen dien nur zu Vergleichswecken. Les references constructeur servent uniquement atitre d' indetification

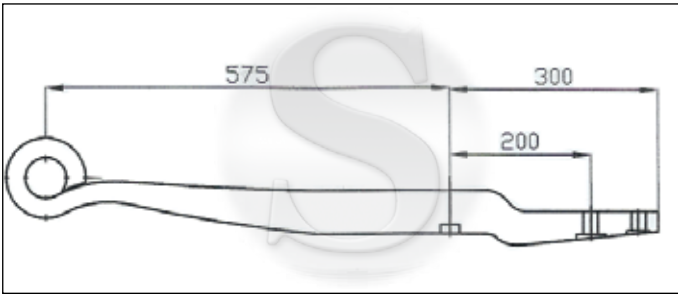

CODE	TYPE	LEA- VES	MATERIAL SIZE	LENGTH		EYE	
				F	R	F	R
5731100		1	71x62	575	300		

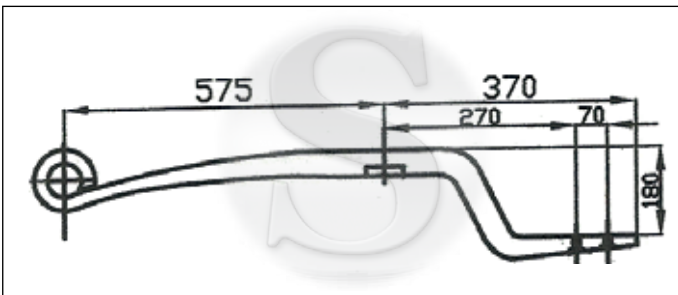

CODE	TYPE	LEA- VES	MATERIAL SIZE	LENGTH		EYE	
				F	R	F	R
5730400		1	70x55	575	370		

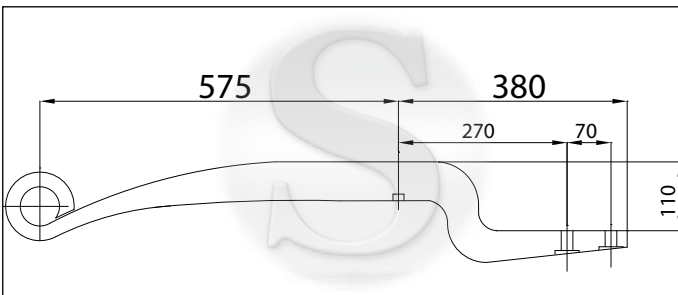

CODE	TYPE	LEA- VES	MATERIAL SIZE	LENGTH		EYE	
				F	R	F	R
5730500		1	70x62	575	370		

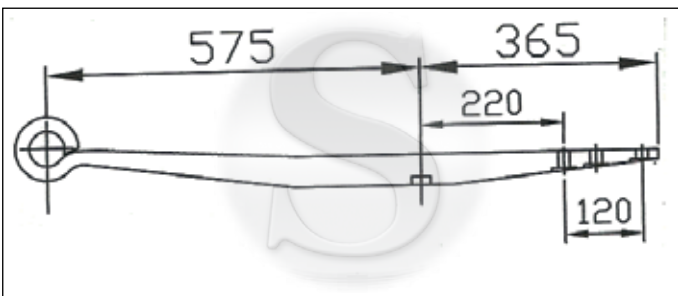

CODE	TYPE	LEA- VES	MATERIAL SIZE	LENGTH		EYE	
				F	R	F	R
5101650		1	100x48	575	365		

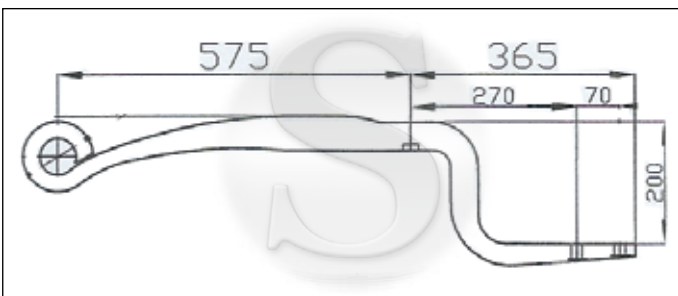

CODE	TYPE	LEA- VES	MATERIAL SIZE	LENGTH		EYE	
				F	R	F	R
5730600		1	70x56	575	365		

Any reference to manufacture' s numbers are for the comparison purpose only. Alle Hersteller-Referenzen dien nur zu Vergleichswecken. Les references constructeur servent uniquement atitre d' indetification

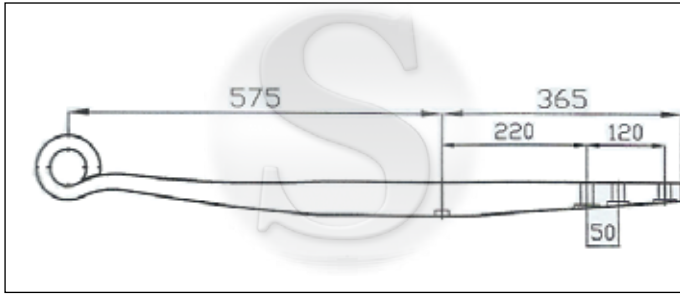

CODE	TYPE	LEAVES	MATERIAL SIZE	LENGTH		EYE	
				F	R	F	R
5730050		1	100x51	575 - 365			

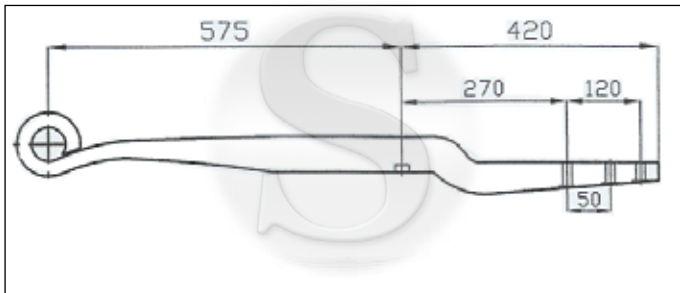

CODE	TYPE	LEAVES	MATERIAL SIZE	LENGTH		EYE	
				F	R	F	R
5730800		1	70x56	575 - 420			

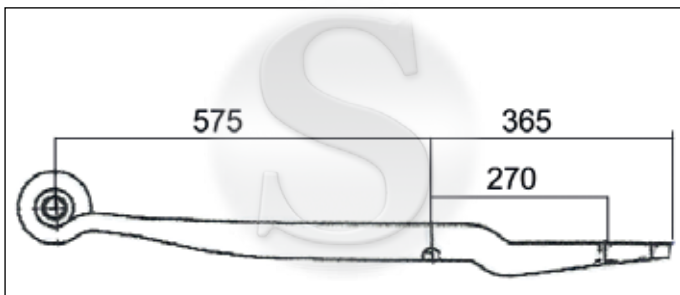

CODE	TYPE	LEAVES	MATERIAL SIZE	LENGTH		EYE	
				F	R	F	R
5730700		1	70x62	575 - 365			

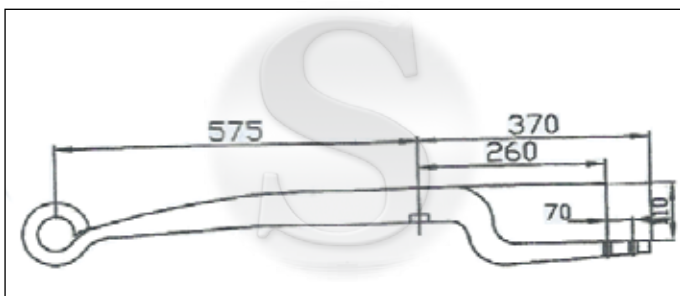

CODE	TYPE	LEAVES	MATERIAL SIZE	LENGTH		EYE	
				F	R	F	R
5730900		1	70x62	575 - 370			

Any reference to manufacture' s numbers are for the comparison purpose only. Alle Hersteller-Referenzen dien nur zu Vergleichswecken. Les references constructeur servent uniquement atitre d' indetification

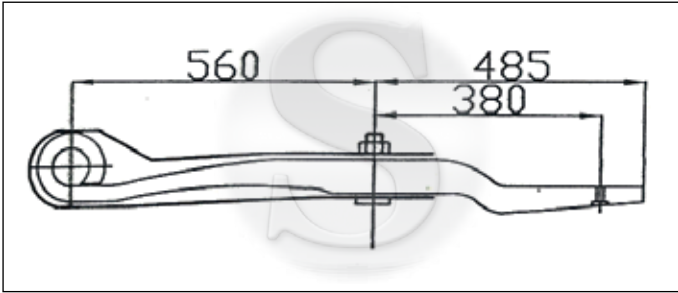

CODE	TYPE	LEA- VES	MATERIAL SIZE	LENGTH		EYE	
				F	R	F	R

5104700		1	100x54	560	485		

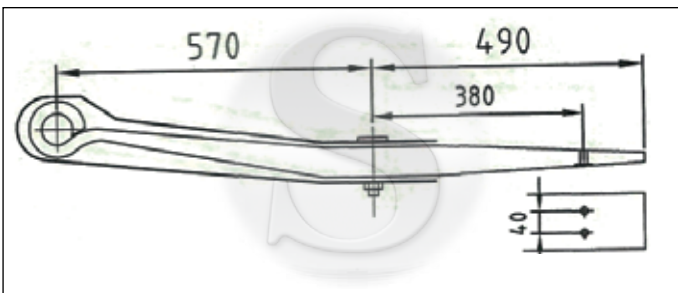

CODE	TYPE	LEA- VES	MATERIAL SIZE	LENGTH		EYE	
				F	R	F	R

5104720		1	100x54	570	490		

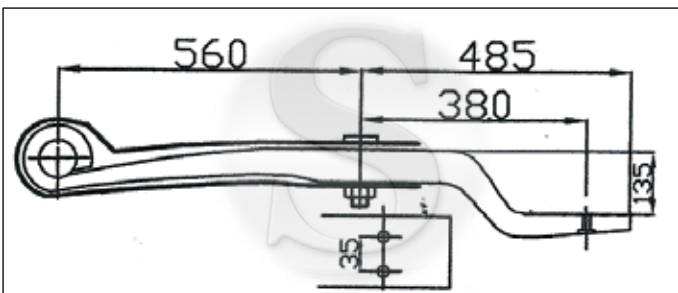

CODE	TYPE	LEA- VES	MATERIAL SIZE	LENGTH		EYE	
				F	R	F	R

5104840		1	100x53	560	485		

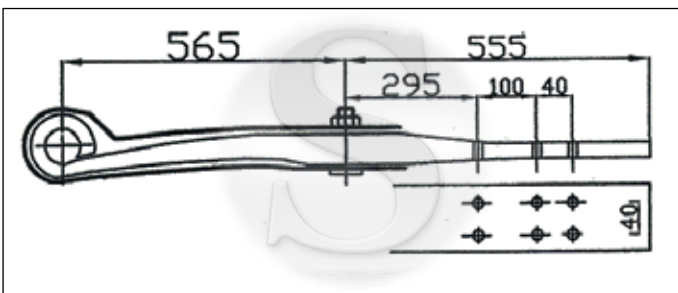

CODE	TYPE	LEA- VES	MATERIAL SIZE	LENGTH		EYE	
				F	R	F	R

5104850		1	100x54	565	555		

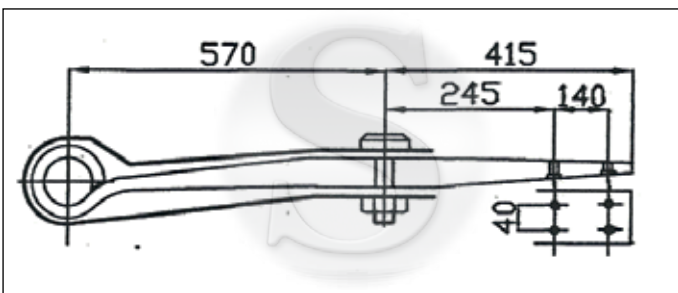

CODE	TYPE	LEA- VES	MATERIAL SIZE	LENGTH		EYE	
				F	R	F	R

5104750		1	100x54	565	410		

Any reference to manufacture' s numbers are for the comparison purpose only. Alle Hersteller-Referenzen dien nur zu Vergleichswecken. Les references constructeur servent uniquement atitre d' indetification

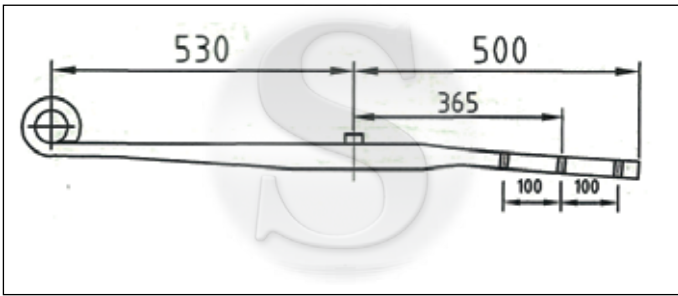

CODE	TYPE	LEA- VES	MATERIAL SIZE	LENGTH		EYE	
				F	R	F	R
5104730		1	100x45	530	500		

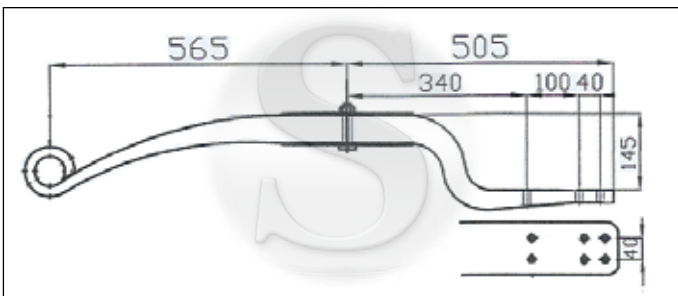

CODE	TYPE	LEA- VES	MATERIAL SIZE	LENGTH		EYE	
				F	R	F	R
5104950		1	100x54	565	505		

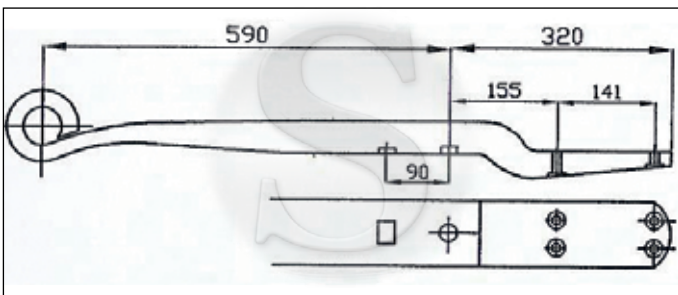

CODE	TYPE	LEA- VES	MATERIAL SIZE	LENGTH		EYE	
				F	R	F	R
5104650		1	95x49	590	320		

Any reference to manufacture's numbers are for the comparison purpose only. Alle Hersteller-Referenzen dien nur zu Vergleichswecken. Les references constructeur servent uniquement atitre d' indetification

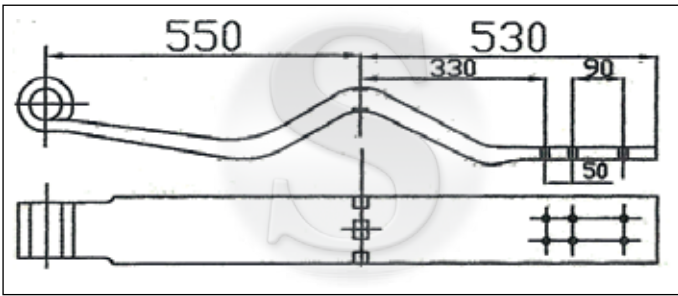

CODE	TYPE	LEAVES	MATERIAL SIZE	LENGTH		EYE	
				F	R	F	R
5104860		1	120x45	550	530		

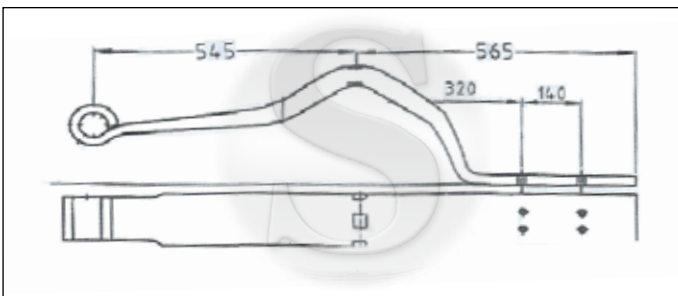

CODE	TYPE	LEAVES	MATERIAL SIZE	LENGTH		EYE	
				F	R	F	R
5104910		1	120x45	545	565		

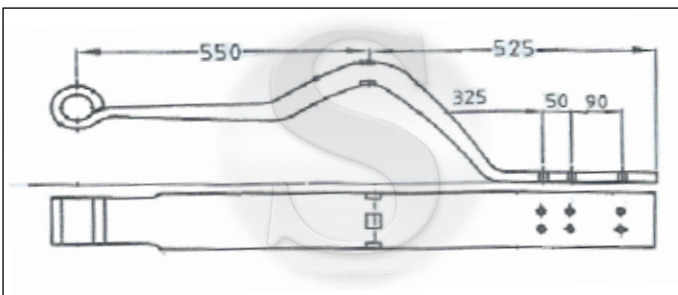

CODE	TYPE	LEAVES	MATERIAL SIZE	LENGTH		EYE	
				F	R	F	R
5104890		1	120x45	550	525		

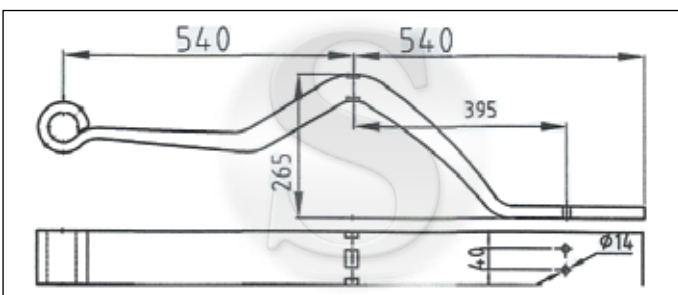

CODE	TYPE	LEAVES	MATERIAL SIZE	LENGTH		EYE	
				F	R	F	R
5104930		1	100x49	540	540		

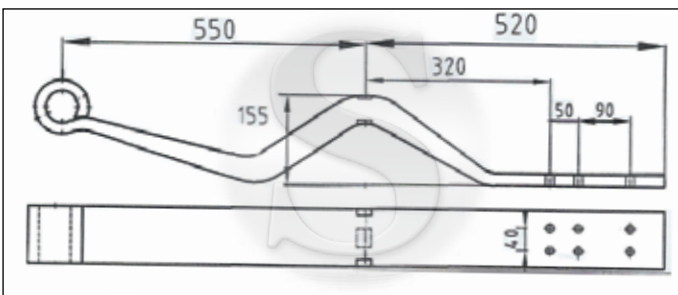

CODE	TYPE	LEAVES	MATERIAL SIZE	LENGTH		EYE	
				F	R	F	R
5104940		1	100x49	550	520		

Any reference to manufacture' s numbers are for the comparison purpose only. Alle Hersteller-Referenzen dien nur zu Vergleichswecken. Les references constructeur servent uniquement atitre d' indetification

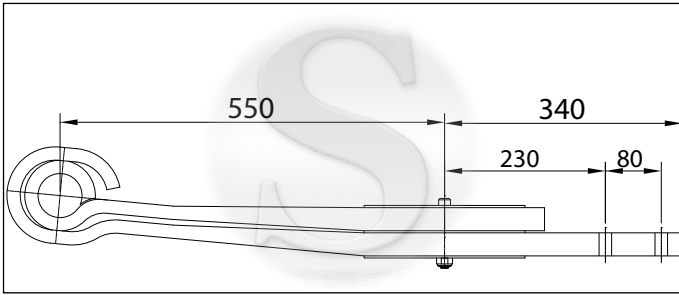

CODE	TYPE	LEAVES	MATERIAL SIZE	LENGTH		EYE	
				F	R	F	R
5104000		2		550 - 340			
5104001			80x33				
5104002			80x33				

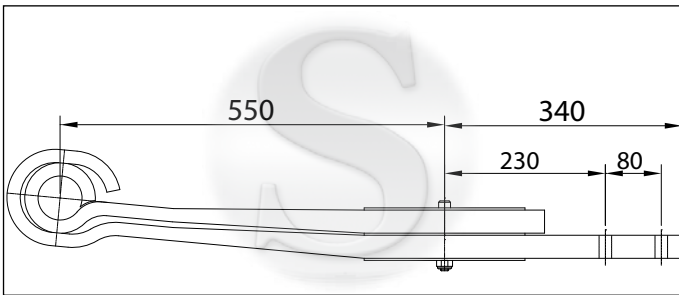

CODE	TYPE	LEAVES	MATERIAL SIZE	LENGTH		EYE	
				F	R	F	R
5104100		2		550 - 340			
5104101			80x33			SQUARE	
5104102			80x33			PIN	

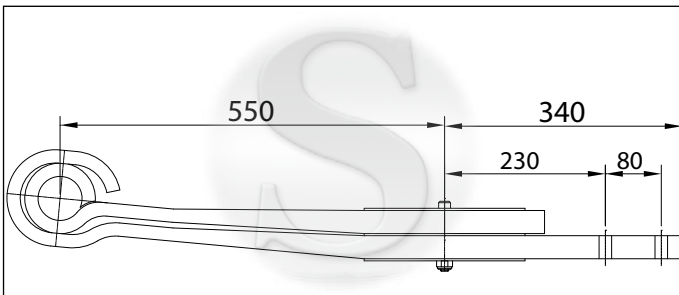

CODE	TYPE	LEAVES	MATERIAL SIZE	LENGTH		EYE	
				F	R	F	R
5100400		2		550 - 340			
5100401			80x40				
5100402			80x40				

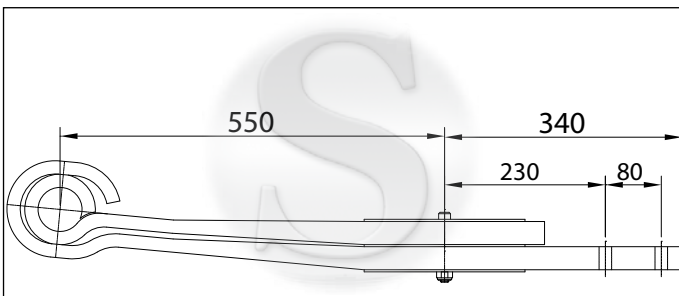

CODE	TYPE	LEAVES	MATERIAL SIZE	LENGTH		EYE	
				F	R	F	R
5101200		2		550 - 340			
5101201			80x40			SQUARE	
5101202			80x40			PIN	

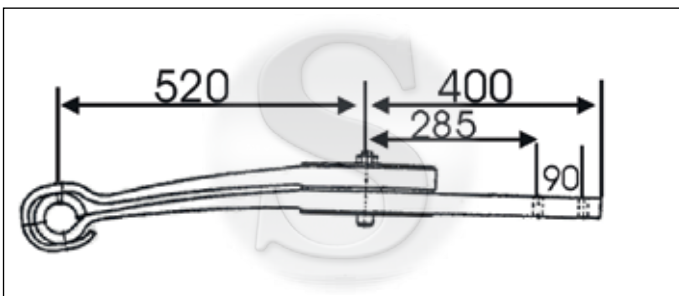

CODE	TYPE	LEAVES	MATERIAL SIZE	LENGTH		EYE	
				F	R	F	R
5931000		2	100x40	520 - 340			

Any reference to manufacture's numbers are for the comparison purpose only. Alle Hersteller-Referenzen dien nur zu Vergleichswecken. Les references constructeur servent uniquement atitre d' indetification

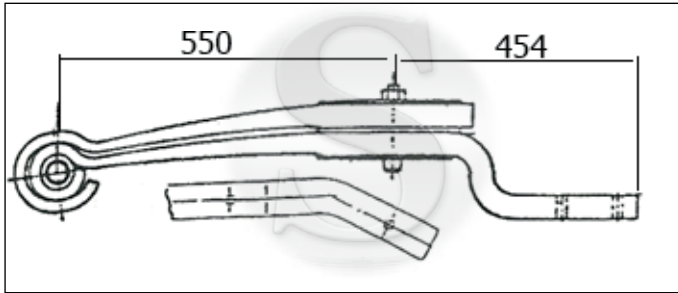

CODE	TYPE	LEA- VES	MATERIAL SIZE	LENGTH		EYE	
				F	R	F	R
5931100		2	80x38	550	454		

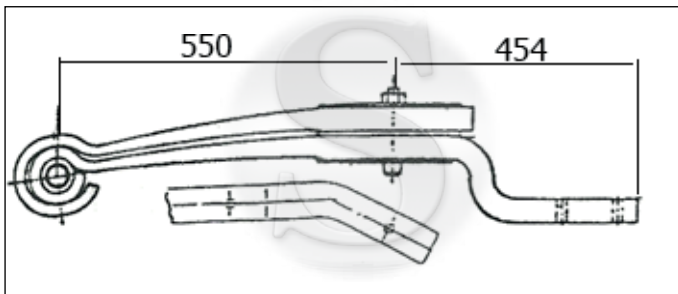

CODE	TYPE	LEA- VES	MATERIAL SIZE	LENGTH		EYE	
				F	R	F	R
5931200		2	80x38	550	454		

Any reference to manufacture' s numbers are for the comparison purpose only. Alle Hersteller-Referenzen dien nur zu Vergleichswecken. Les references constructeur servent uniquement atitre d' indetification

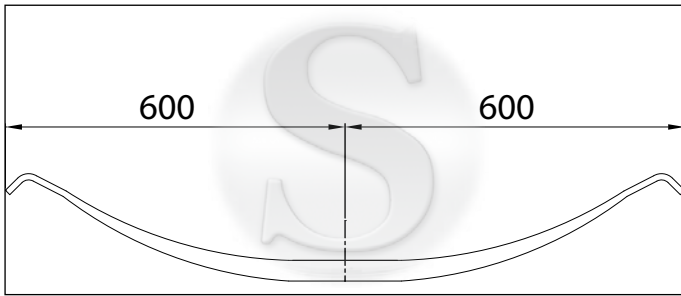

CODE	TYPE	LEAVES	MATERIAL SIZE	LENGTH		EYE	
				F	R	F	R
5100200		1	75x41	600	600		

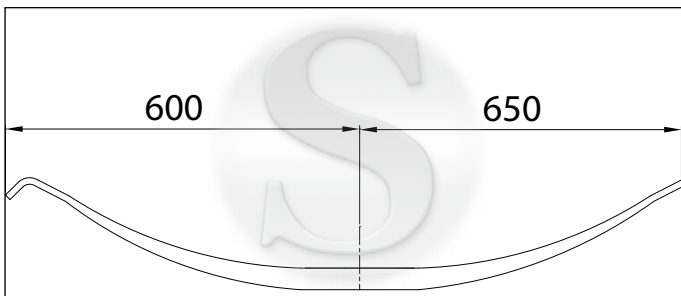

CODE	TYPE	LEAVES	MATERIAL SIZE	LENGTH		EYE	
				F	R	F	R
5100300		1	75x41	600	650		

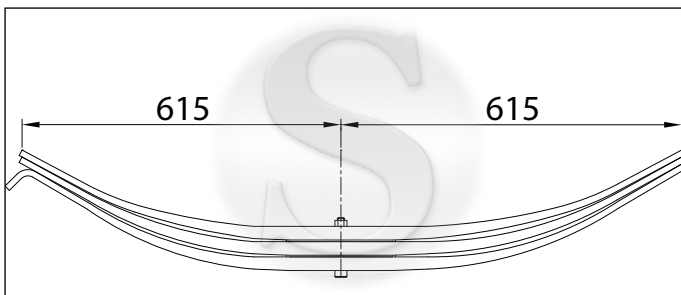

CODE	TYPE	LEAVES	MATERIAL SIZE	LENGTH		EYE	
				F	R	F	R
5810000		3	75x25	615	615		

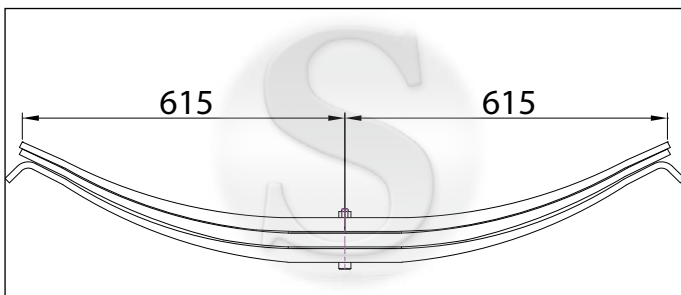

CODE	TYPE	LEAVES	MATERIAL SIZE	LENGTH		EYE	
				F	R	F	R
5102100		3	75x25	615	615		

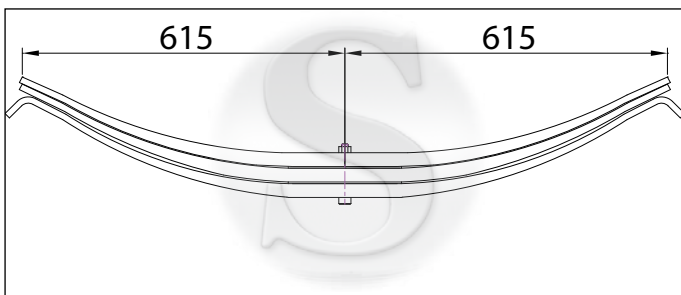

CODE	TYPE	LEAVES	MATERIAL SIZE	LENGTH		EYE	
				F	R	F	R
5102800		3	75x25	600	600		

Any reference to manufacture' s numbers are for the comparison purpose only. Alle Hersteller-Referenzen dien nur zu Vergleichswecken. Les references constructeur servent uniquement atitre d' indetification

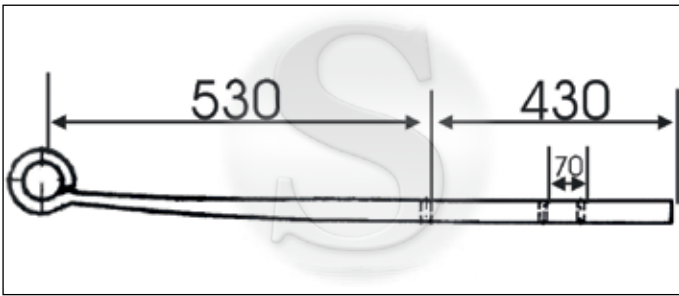

CODE	TYPE	LEAVES	MATERIAL SIZE	LENGTH		EYE	
				F	R	F	R
5104800		1	100x45	530	430		

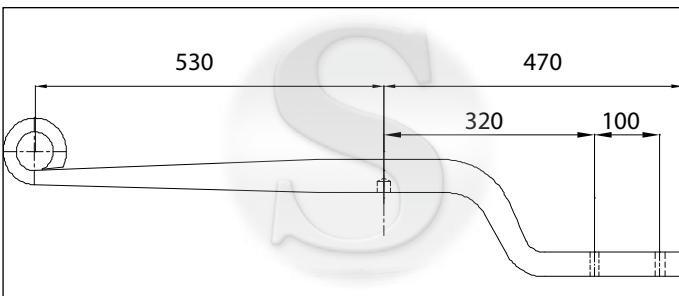

CODE	TYPE	LEAVES	MATERIAL SIZE	LENGTH		EYE	
				F	R	F	R
5101300		1	100x45	530	470		

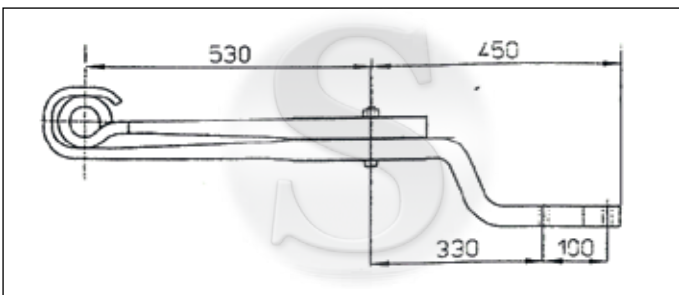

CODE	TYPE	LEAVES	MATERIAL SIZE	LENGTH		EYE	
				F	R	F	R
5101310		2	100x35	530	450		

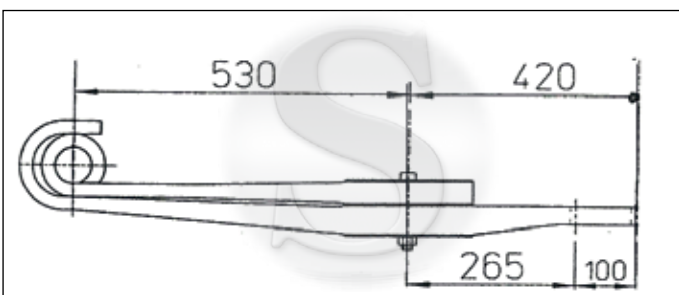

CODE	TYPE	LEAVES	MATERIAL SIZE	LENGTH		EYE	
				F	R	F	R
5101320		2		530	420		
5101321			100x40				
5101322			100x40				

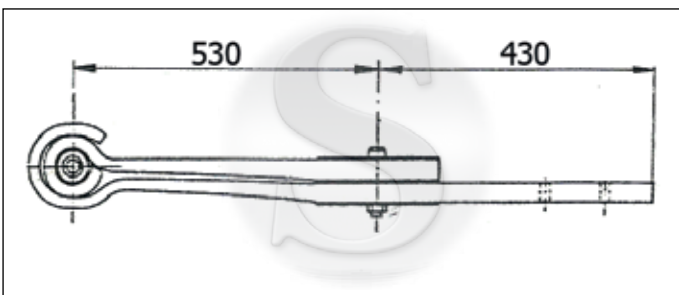

CODE	TYPE	LEAVES	MATERIAL SIZE	LENGTH		EYE	
				F	R	F	R
5105400		2		530	430		
5105401			100x35				
5105402			100x45				

Any reference to manufacture' s numbers are for the comparison purpose only. Alle Hersteller-Referenzen dien nur zu Vergleichswecken. Les references constructeur servent uniquement atitre d' indetification

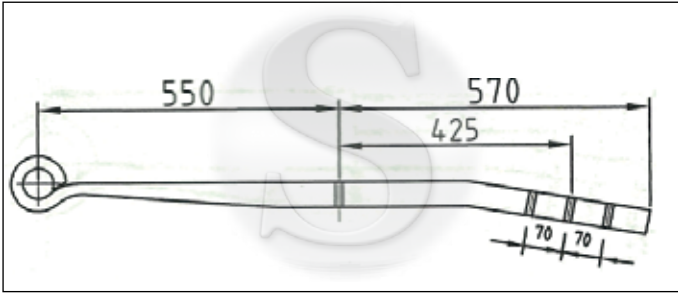

CODE	TYPE	LEAVES	MATERIAL SIZE	LENGTH		EYE	
				F	R	F	R
5104740		1	100x45	550	570		

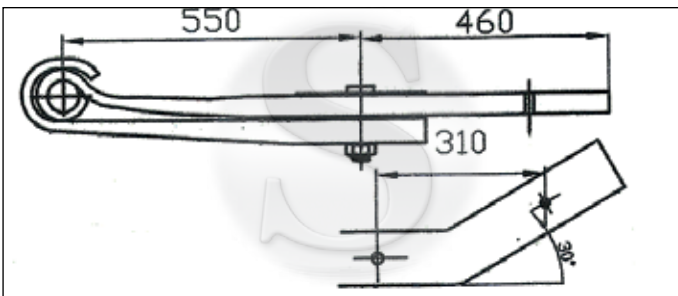

CODE	TYPE	LEAVES	MATERIAL SIZE	LENGTH		EYE	
				F	R	F	R
5104830		2		550	460		
5104831			100x40				
5104832			100x33				

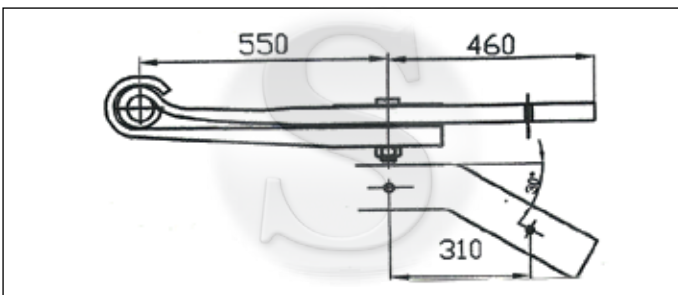

CODE	TYPE	LEAVES	MATERIAL SIZE	LENGTH		EYE	
				F	R	F	R
5104820		2		550	460		
5104821			100x40				
5104822			100x33				

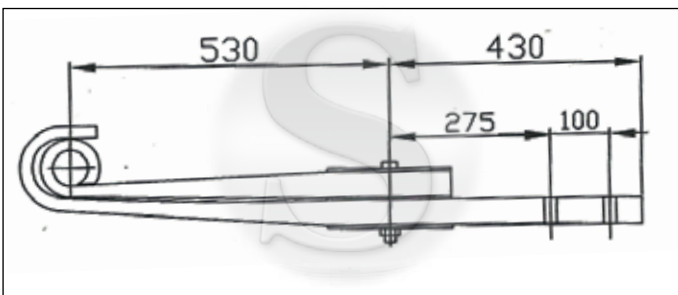

CODE	TYPE	LEAVES	MATERIAL SIZE	LENGTH		EYE	
				F	R	F	R
5105500		2	100x45	530	430		

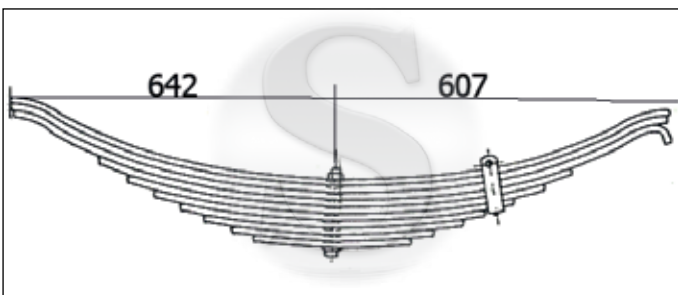

CODE	TYPE	LEAVES	MATERIAL SIZE	LENGTH		EYE	
				F	R	F	R
6000009		10	75x13	642	607		

Any reference to manufacture' s numbers are for the comparison purpose only. Alle Hersteller-Referenzen dien nur zu Vergleichswecken. Les references constructeur servent uniquement atitre d' indetification

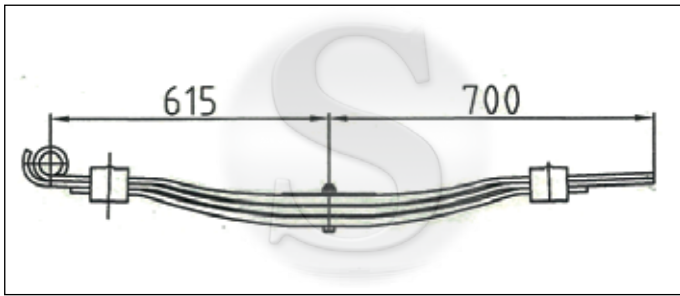

CODE	TYPE	LEA- VES	MATERIAL SIZE	LENGTH		EYE	
				F	R	F	R
5710000		3	100x20	615 - 700			

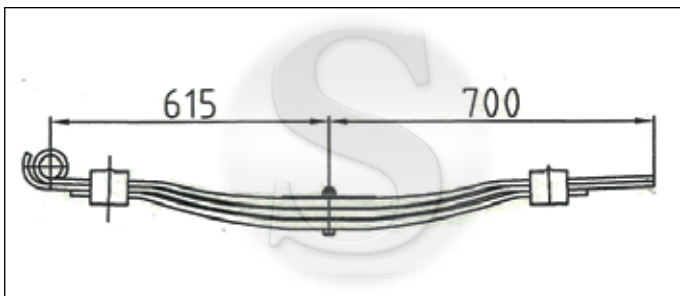

CODE	TYPE	LEA- VES	MATERIAL SIZE	LENGTH		EYE	
				F	R	F	R
5710110		3	100x24	615 - 700			

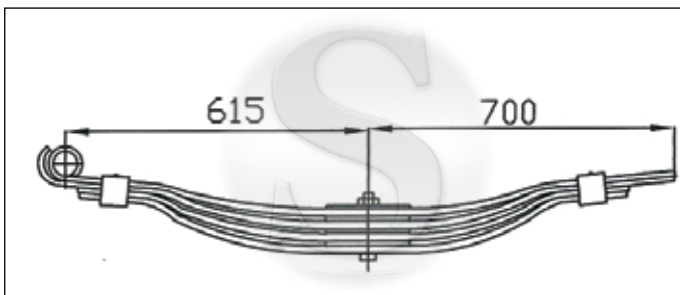

CODE	TYPE	LEA- VES	MATERIAL SIZE	LENGTH		EYE	
				F	R	F	R
5104880		4	100x22	615 - 700			

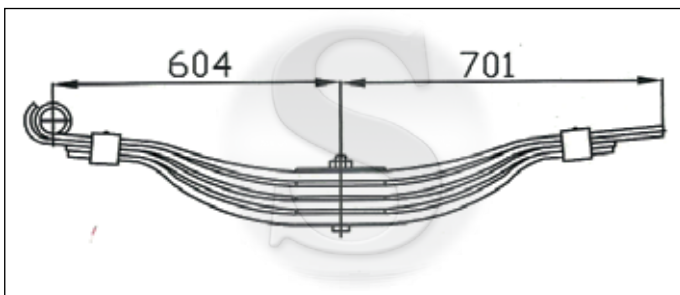

CODE	TYPE	LEA- VES	MATERIAL SIZE	LENGTH		EYE	
				F	R	F	R
5710100		4	100x25	604 - 701			

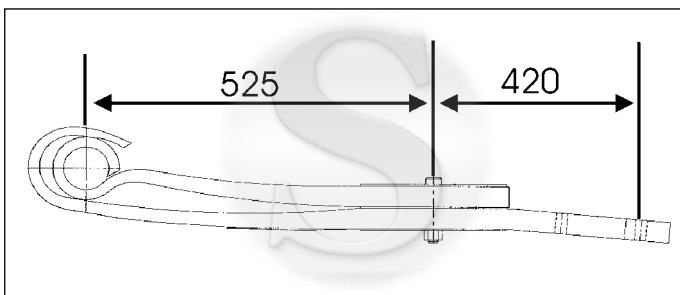

CODE	TYPE	LEA- VES	MATERIAL SIZE	LENGTH		EYE	
				F	R	F	R
5104600		2	100x40	525 - 420			

Any reference to manufacture' s numbers are for the comparison purpose only. Alle Hersteller-Referenzen dien nur zu Vergleichswecken. Les references constructeur servent uniquement atitre d' indetification

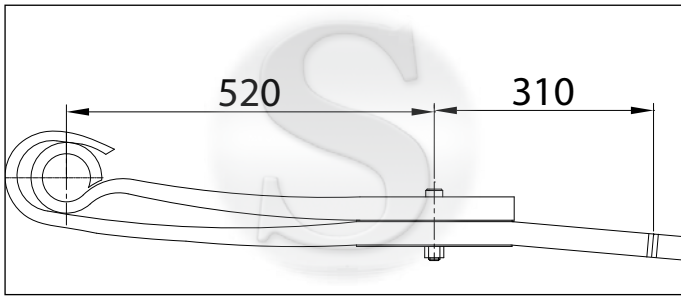

CODE	TYPE	LEA- VES	MATERIAL SIZE	LENGTH		EYE	
				F	R	F	R
5104500		2	100x33	520 - 310			

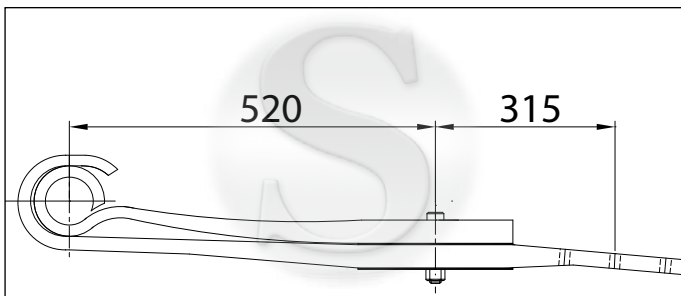

CODE	TYPE	LEA- VES	MATERIAL SIZE	LENGTH		EYE	
				F	R	F	R
5104300		2	100x40	520 - 315			

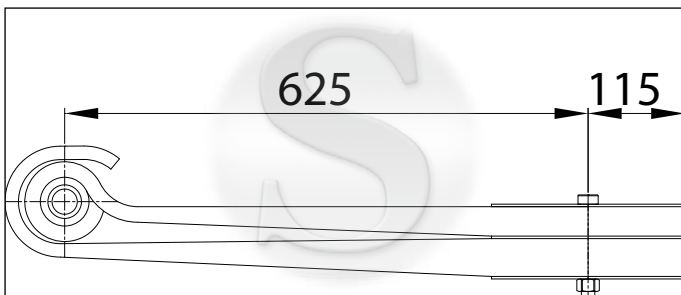

CODE	TYPE	LEA- VES	MATERIAL SIZE	LENGTH		EYE	
				F	R	F	R
5104400		2		625 - 115			
5104401			100x35				
5104402			100x45				

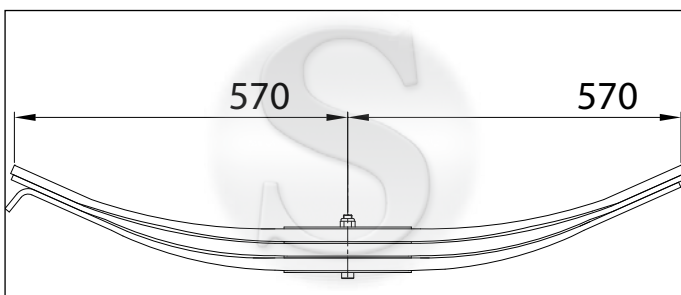

CODE	TYPE	LEA- VES	MATERIAL SIZE	LENGTH		EYE	
				F	R	F	R
5104870		3	90x21	570 - 570			

Any reference to manufacture' s numbers are for the comparison purpose only. Alle Hersteller-Referenzen dien nur zu Vergleichswecken. Les references constructeur servent uniquement atitre d' indetification

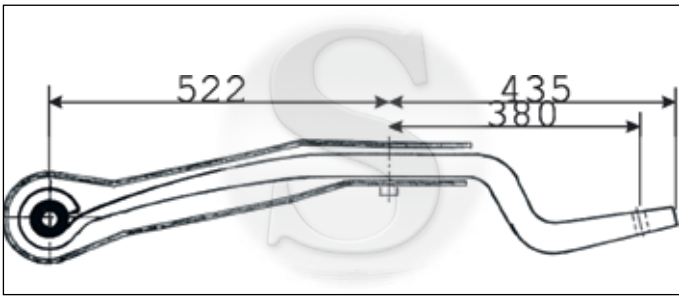

CODE	TYPE	LEAVES	MATERIAL SIZE	LENGTH		EYE	
				F	R	F	R
5101100		1	100x48	522	435		

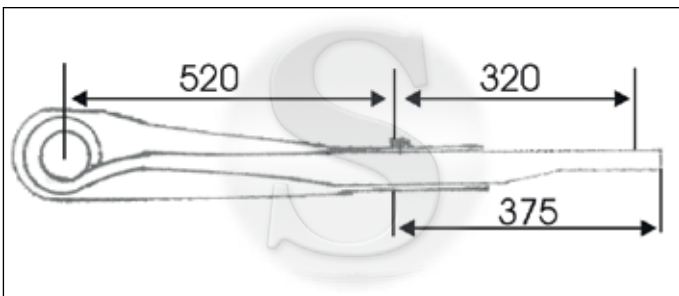

CODE	TYPE	LEAVES	MATERIAL SIZE	LENGTH		EYE	
				F	R	F	R
5861120		1	100x48	520	320		

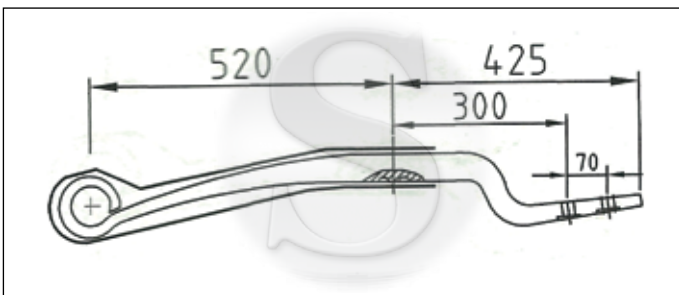

CODE	TYPE	LEAVES	MATERIAL SIZE	LENGTH		EYE	
				F	R	F	R
5861200		1	100x48	520	425		

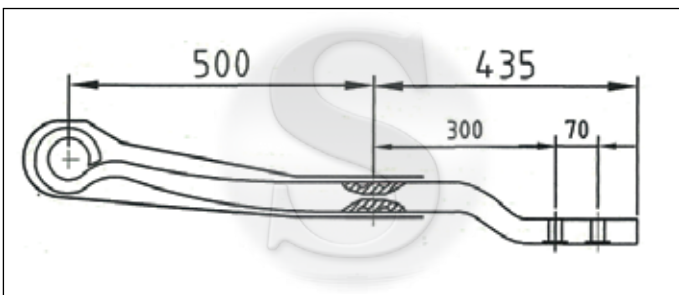

CODE	TYPE	LEAVES	MATERIAL SIZE	LENGTH		EYE	
				F	R	F	R
5861300		1	100x48	500	435		

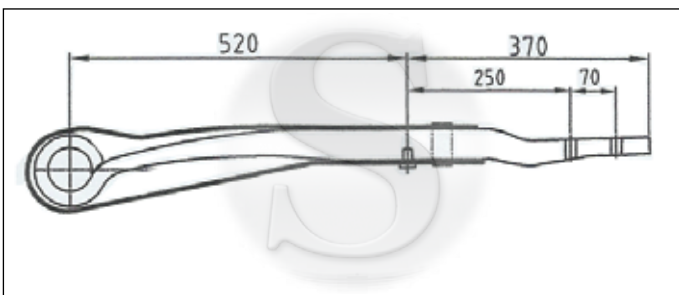

CODE	TYPE	LEAVES	MATERIAL SIZE	LENGTH		EYE	
				F	R	F	R
5861110		1	100x48	520	370		

Any reference to manufacture' s numbers are for the comparison purpose only. Alle Hersteller-Referenzen dien nur zu Vergleichswecken. Les references constructeur servent uniquement atitre d' indetification

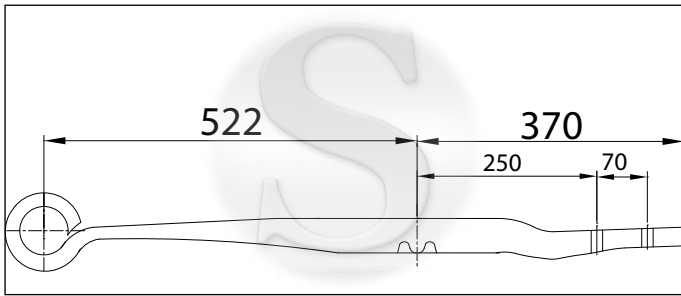

CODE	TYPE	LEAVES	MATERIAL SIZE	LENGTH		EYE	
				F	R	F	R
5102000		1	100x48	520	372		

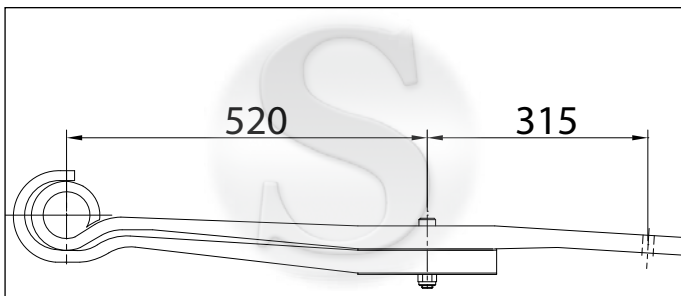

CODE	TYPE	LEAVES	MATERIAL SIZE	LENGTH		EYE	
				F	R	F	R
5890200		1	100x33	520	365		

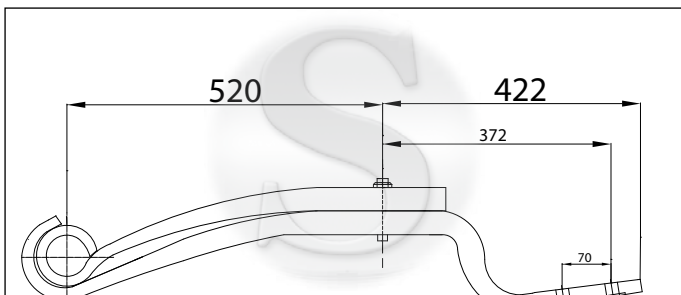

CODE	TYPE	LEAVES	MATERIAL SIZE	LENGTH		EYE	
				F	R	F	R
5861100		2	100x38	520	422		

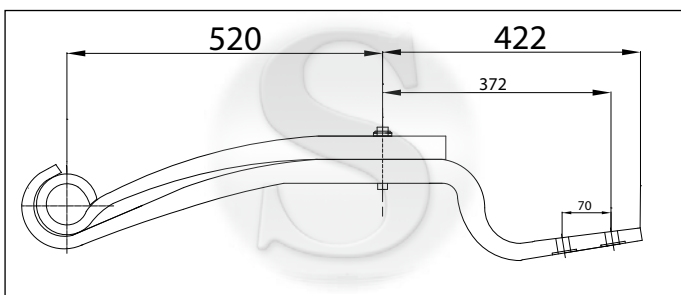

CODE	TYPE	LEAVES	MATERIAL SIZE	LENGTH		EYE	
				F	R	F	R
5861000		2	100x43	520	422		

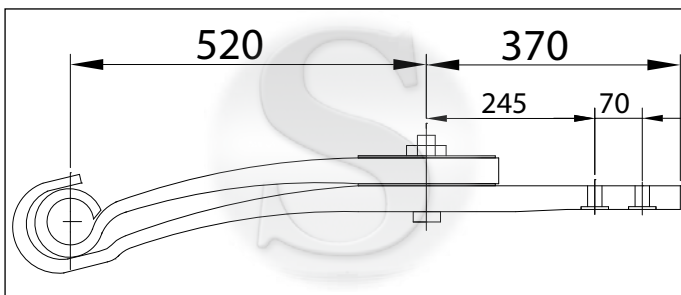

CODE	TYPE	LEAVES	MATERIAL SIZE	LENGTH		EYE	
				F	R	F	R
5861130		2	100x38	520	370		

Any reference to manufacture' s numbers are for the comparison purpose only. Alle Hersteller-Referenzen dien nur zu Vergleichswecken. Les references constructeur servent uniquement atitre d' indetification

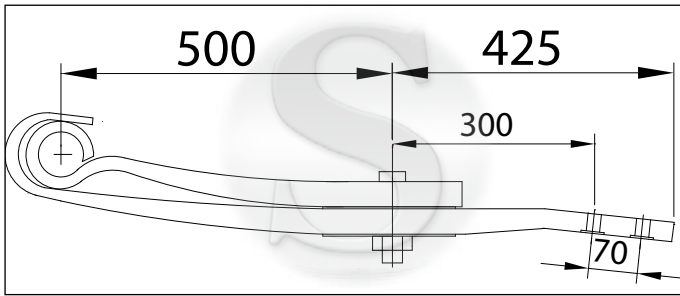

CODE	TYPE	LEA- VES	MATERIAL SIZE	LENGTH		EYE	
				F	R	F	R
5861400		2	100x38	500 - 425			

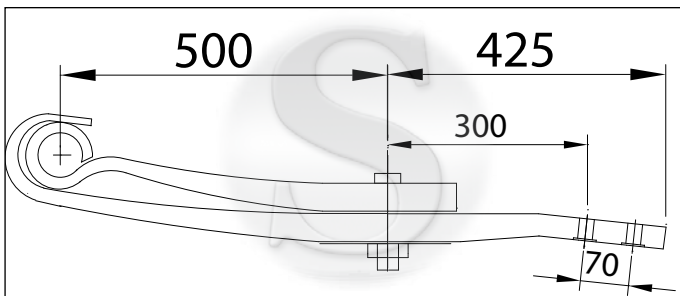

CODE	TYPE	LEA- VES	MATERIAL SIZE	LENGTH		EYE	
				F	R	F	R
5861500		2	100x43	500 - 425			

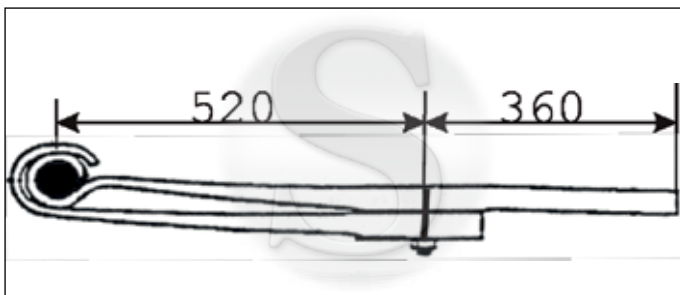

CODE	TYPE	LEA- VES	MATERIAL SIZE	LENGTH		EYE	
				F	R	F	R
5920000		2	100x38	520 - 380			



CODE	TYPE	LEA- VES	MATERIAL SIZE	LENGTH		EYE	
				F	R	F	R
5890000		2	100x43	575 - 55			



CODE	TYPE	LEA- VES	MATERIAL SIZE	LENGTH		EYE	
				F	R	F	R
5890100		2	100x40	575 - 55			

Any reference to manufacture' s numbers are for the comparison purpose only. Alle Hersteller-Referenzen dien nur zu Vergleichswecken. Les references constructeur servent uniquement atitre d' indetification

freuhau

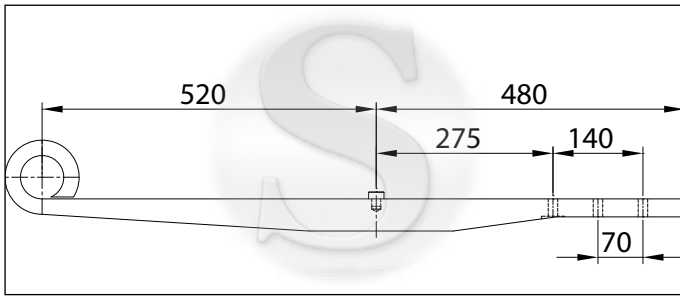

CODE	TYPE	LEA- VES	MATERIAL SIZE	LENGTH		EYE	
				F	R	F	R
5102200		1	100x50	520 - 485			

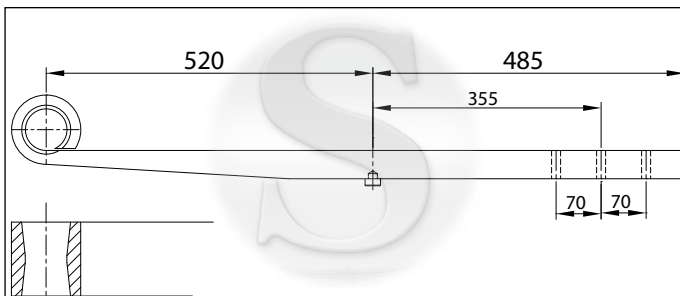

CODE	TYPE	LEA- VES	MATERIAL SIZE	LENGTH		EYE	
				F	R	F	R
5102350		1	115x45	520 - 485			

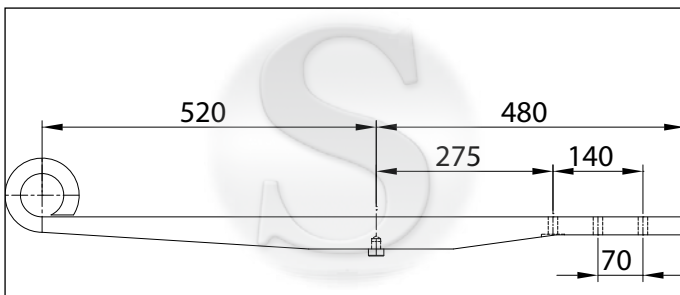

CODE	TYPE	LEA- VES	MATERIAL SIZE	LENGTH		EYE	
				F	R	F	R
5102300		1	100x50	520 - 485			

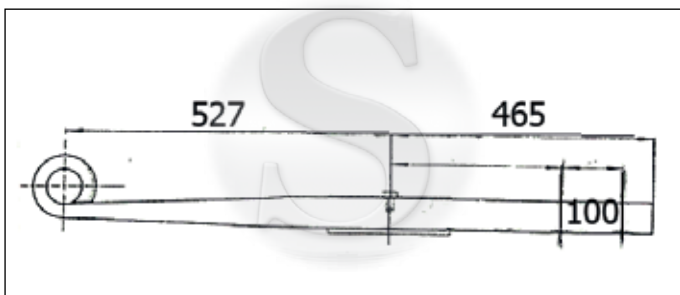

CODE	TYPE	LEA- VES	MATERIAL SIZE	LENGTH		EYE	
				F	R	F	R
5104200		1	100x50	527 - 465			

Any reference to manufacture' s numbers are for the comparison purpose only. Alle Hersteller-Referenzen dien nur zu Vergleichswecken. Les references constructeur servent uniquement atitre d' indetification

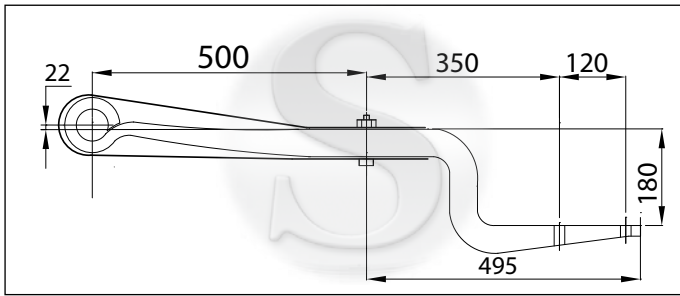

CODE	TYPE	LEA- VES	MATERIAL SIZE	LENGTH		EYE	
				F	R	F	R
5104920		1	100x50	500 - 495			
ZORZI							

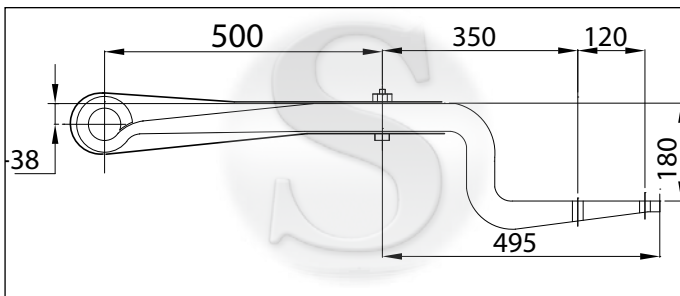

CODE	TYPE	LEA- VES	MATERIAL SIZE	LENGTH		EYE	
				F	R	F	R
5105600		1	100x50	500 - 495			
ZORZI							

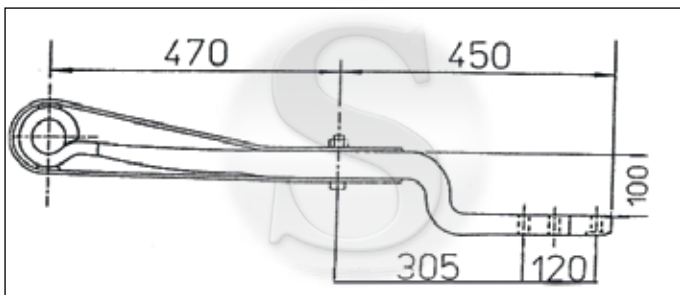

CODE	TYPE	LEA- VES	MATERIAL SIZE	LENGTH		EYE	
				F	R	F	R
5104710		1	100x45	470 - 450			
BARTOLETTI							

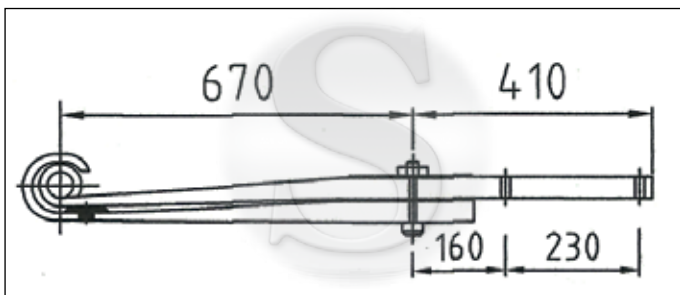

CODE	TYPE	LEA- VES	MATERIAL SIZE	LENGTH		EYE	
				F	R	F	R
5080160		2	70x36	670 - 410			
ISUZU							

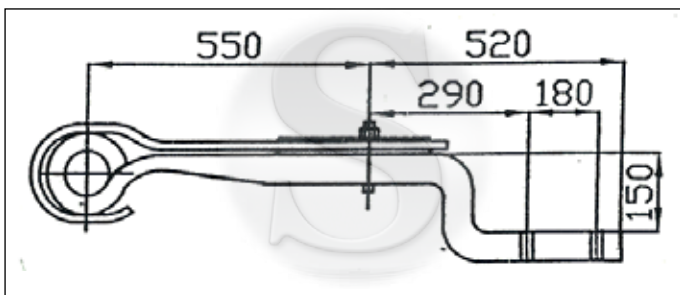

CODE	TYPE	LEA- VES	MATERIAL SIZE	LENGTH		EYE	
				F	R	F	R
5104810		1	100x40	550 - 520			
KAIZER							

Any reference to manufacture' s numbers are for the comparison purpose only. Alle Hersteller-Referenzen dien nur zu Vergleichswecken. Les references constructeur servent uniquement atitre d' indetification

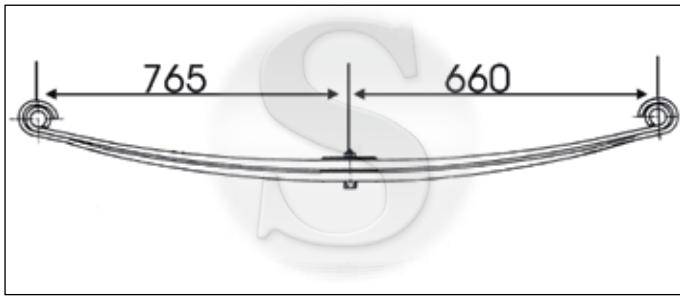

CODE	TYPE	LEA- VES	MATERIAL SIZE	LENGTH		EYE	
				F	R	F	R
5106100		2	100x20	765	660		

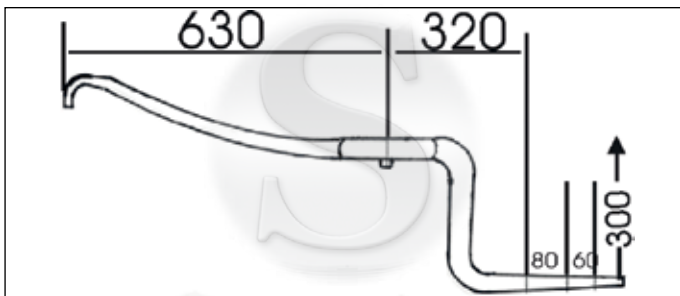

CODE	TYPE	LEA- VES	MATERIAL SIZE	LENGTH		EYE	
				F	R	F	R
5106200		1	90x38	630	320		

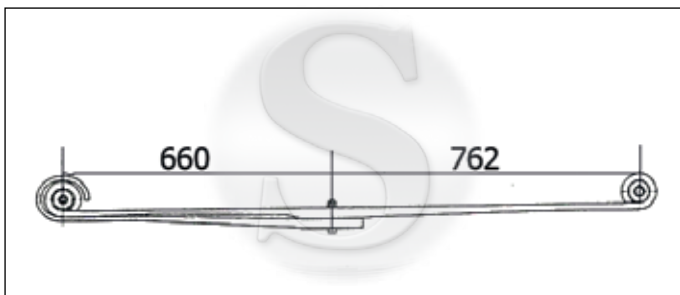

CODE	TYPE	LEA- VES	MATERIAL SIZE	LENGTH		EYE	
				F	R	F	R
5106300		2		660	762		
			100x27				
			100x21				

Any reference to manufacture' s numbers are for the comparison purpose only. Alle Hersteller-Referenzen dien nur zu Vergleichswecken. Les references constructeur servent uniquement atitre d' indetification

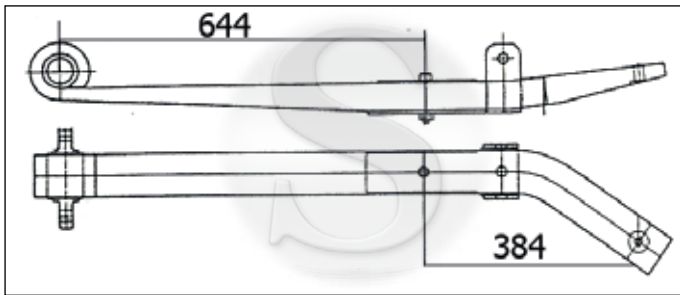

CODE	TYPE	LEAVES	MATERIAL SIZE	LENGTH		EYE	
				F	R	F	R
5106700		2	76x51	644 - 384			

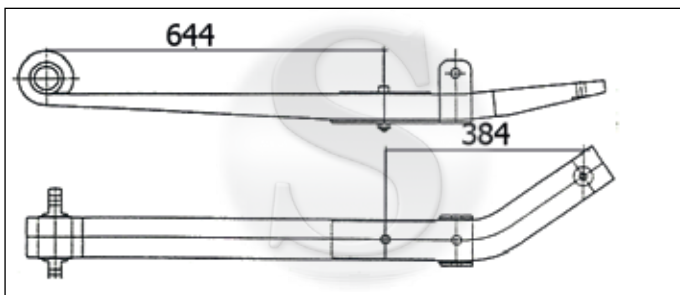

CODE	TYPE	LEAVES	MATERIAL SIZE	LENGTH		EYE	
				F	R	F	R
5106600		2	76x51	644 - 384			

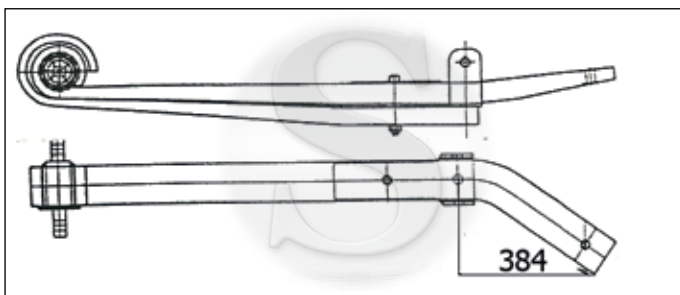

CODE	TYPE	LEAVES	MATERIAL SIZE	LENGTH		EYE	
				F	R	F	R
5106400		2	76x51	644 - 384			

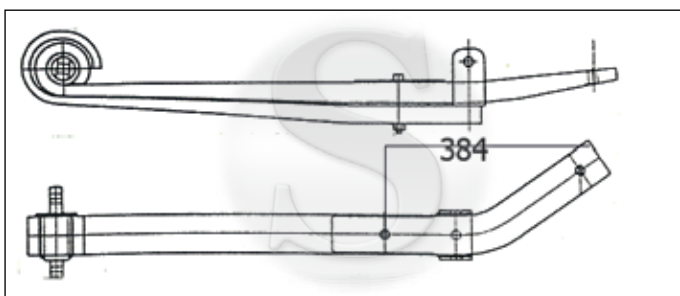

CODE	TYPE	LEAVES	MATERIAL SIZE	LENGTH		EYE	
				F	R	F	R
5106500		2	76x51	644 - 384			

Any reference to manufacture' s numbers are for the comparison purpose only. Alle Hersteller-Referenzen dien nur zu Vergleichswecken. Les references constructeur servent uniquement atitre d' indetification



Any reference to manufacture' s numbers are for the comparison purpose only. Alle Hersteller-Referenzen dien nur zu Vergleichswecken. Les references constructeur servent uniquement atitre d' indetification



MERCEDES	PAGE	5064910	9703201402	10	MERCEDES	PAGE		
5063010	9493200202	4	5064930	9743200002	10	5063220	9483200605	17
5063410	9493200302	4	5064940	9743204202	10	5066800	9483201405	17
5063110	9493200402	4	5064950	9743202602	10	5066810	9483201105	17
5063510	9493200502	4				5063520	9483201205	17
5063810	6553203002	4				5063320	9483200705	17
			MERCEDES	PAGE				
			5062510	6743500706	11			
			5062410	6753500706	11	MERCEDES	PAGE	
MERCEDES	PAGE	5062430	6753500106	11	5063420	9483201005	18	
5063610	9443200202	5	5060710	6743203406	11	5062420	6193200405	18
5063710	9433200302	5	5060810	6753202806	11	5062720	6483200006	18
5062610	6533200002	5				6060620	6243200106	18
5065610	9433200402	5						
5065910	6593200502	5	MERCEDES	PAGE				
			5064320	9023200401	12	MAN	PAGE	
			5063930	9013200001	12	5031300	81434006337	19
MERCEDES	PAGE	5064120	9043200401	12	5031200	81434006368	19	
5066610	9443200302	6	5064720	9723500506	12	5031810	81434026053	19
5067400	9433200502	6	5064820	9723500106	12	5031610	81434026019	19
5067410	9433200702	6				5032400	81434006456	19
5066910	9493200602	6						
5066500	9443200102	6	MERCEDES	PAGE				
			5064230	9063201806	13	MAN	PAGE	
			5064250	9063203206	13	5030820	81434026529	20
MERCEDES	PAGE	5064260	9303201706	13	5032130	81434006903	20	
5065220	9743200406	7	5064220	9033200806	13	5032490	81434026632	20
5065720	9433200208	7	5066710	9033200406	13	5032420	81434026533	20
5065820	9433200308	7				5032460	81434006990	20
5067320	9743500606	7	MERCEDES	PAGE				
5064960	9743204402	7	5060000	6023200302	14	MAN	PAGE	
			5064020	9043200606	14	5031700	81434006409	21
			5065510	9033200606	14	5032470	81434006425	21
MERCEDES	PAGE	5063310	6313201206	14	5030150	81434026622	21	
5063330	9743200106	8	5067140	9063200406	14			
5063230	9473200206	8				MAN	PAGE	
5064060	9043201606	8	MERCEDES	PAGE	5030910	81434026098	22	
5067210	6703201906	8	5064210	6673203702	15	5031110	81434026199	22
5064050	9063200206	8	5067520	9043201706	15	5030830	81434026060	22
			5064240	9033202906	15	5031500	81434026007	22
MERCEDES	PAGE	5066110	6743204202	15	5030210	81434006465	22	
5067010	0003200102	9	5067200	9703200806	15			
5067110	0003200202	9				MAN	PAGE	
5066310	6743203802	9	MERCEDES	PAGE	5031900	81434006333	23	
5061010	6173200502	9	5064040	9043200601	16	5031400	81434006495	23
5062110	6753204802	9	5080400	9703172085	16	5032500	81434026127	23
						5032440	81434026185	23
MERCEDES	PAGE							
5064920	9703200802	10						

Any reference to manufacture' s numbers are for the comparison purpose only. Alle Hersteller-Referenzen dien nur zu Vergleichswecken. Les references constructeur servent uniquement atitre d' indetification



5032430	81434026182	23	6030420	81434006666	30	VOLVO		PAGE
			6030430	81434026548	30	6010910	257658	37
	MAN	PAGE	6030710	82434026501	30	6010920	257654	37
5032480	81434026142	24				5012230	257659	37
5030140	81434026258	24	VOLVO		PAGE	6010720	257624	37
5032520	81434026178	24	5011210	257459	31			
5032190	81434026184	24	5010910	257430	31	SCANIA		PAGE
			5010710	257433	31	5040610	1377666	38
	MAN	PAGE	5010620	257428	31	5041010	1377668	38
5032180	81434026592	25				5040910	1377670	38
5032450	81434006455	25	VOLVO		PAGE	5040170	1479518	38
5032170	81434026140	25	5011310	257857	32	5040180	1377712	38
5032010	81434026227	25	5011710		32			
5032440	81434026185	25	5011810	257854	32	SCANIA		PAGE
			5012010	257860	32	5040820	1377804	39
	MAN	PAGE	5012110	257840	32	5040520	388049	39
5032120	81434026101	26				5040230		39
5031600	81434026058	26	VOLVO		PAGE	5041040	1769877	39
5032160	81434026309	26	5012140	6790821	33	5041050	1769877	39
5032600	81434026325	26	5012160	6790819	33			
5032200	81434026050	26	5012200	3123973	33	SCANIA		PAGE
			5012190	3127297	33	5040120	1421061	40
	MAN	PAGE	5012170	257868	33	5040130	1421060	40
5032300	81434026281	27				5040160	1425509	40
5030230	81434026263	27	VOLVO		PAGE	5040150	1425510	40
5030240	85434026005	27	5012210	257861	34		~	
5030220	85434026038	27	5012300	257492	34			
5031910	81434026050	27	5012270	257813	34	SCANIA		PAGE
			5010760	257939	34	6040190	1547824	41
	MAN	PAGE				6040130	1398988	41
5032110	81434026197	28	VOLVO		PAGE	6040120	1398987	41
5032510	81434026195	28	5012180	257927	35	6040150	1479937	41
5032620	82434026505	28	5012220	257895	35			
5032610	81434026290	28	5012260	257888	35	DAF		PAGE
			5012230	257928	35	5020910	1279672	42
	MAN	PAGE	~			5020610	069757	42
5032310	81434026681	29				5020520	1401538	42
5032410	81434026605	29	VOLVO		PAGE	5020920	1381683	42
5030630	81434006929	29	5012240	257871	36	5020310	1405329	42
5030620	81434006875	29	5012250	257900	36			
			~			DAF		PAGE
	MAN	PAGE	~			6020110	0667199	43
5030720	81434006867	30				6020120	0667198	43
5032700	81434026648	30						

Any reference to manufacture' s numbers are for the comparison purpose only. Alle Hersteller-Referenzen dien nur zu Vergleichswecken. Les references constructeur servent uniquement atitre d' indetification



IVECO		PAGE	6200100	98162398	51	BPW		PAGE
5080300	504054605	44	6200200	246388/00	51	5721900	0508213080	58
5070160	41031510	44	6200300	98182388	51	5721200	0508202510	58
5072220	41213904	44		~		5103600	0508212180	58
5070230	500340499	44				PAGE	0508202650	58
						5105000	~	
			5750000	0508203100	52			
IVECO		PAGE	5720000	0508203320	52			
5070200	42126923	45	5103400	0508204260	52	BPW		PAGE
5070400	41226235	45	5790000	0508204120	52	5102600	0508213260	59
5070170	41270468	45	5103100	0508204121	52	5100700	0508202680	59
5070140	8161628	45				5900000	0508212640	59
5070150	8161631	45				PAGE	0508212840	59
						5721800	0508212840	59
			5730000	0508204080	53	5721700	0508212630	59
IVECO		PAGE	5103900	0508202940	53	BPW		PAGE
6070120	42121640	46	6940000	0508203020	53	5762000	0508212840	60
6070130	42033957	46		~		5763000	0508202380	60
				~		5760000	0508202360	60
						5761000	0508212770	60
							~	
RENAULT		PAGE			PAGE			
5075100	5010294113	47			54			
5075600	850021/00	47	5782000	880310/00	54	BPW		PAGE
5075300	5010383762	47	5781000	0508203441	54	5721100	0508213520	61
5075800	5010294204	47	5780000	0508203520	54	5101900	0508213510	61
5075900	5010557732	47	5870000	0508203401	54	5103200	0508212930	61
			5103000	0508204140	54	5101000	0508213190	61
						PAGE	0508212920	61
						5101600		
RENAULT		PAGE			PAGE			
5075400	5010239209	48			55	BPW		PAGE
5075500	5010239210	48	5102400	0508213210	55	5101400	0508212470	62
5075940	5010600023	48	5770000	0508202440	55	5101500	0508212730	62
5075950	5010600024	48	5771000	0508202710	55	5100000	0508212462	62
5075700	5010557474	48	5772000	0508212830	55	5100100	0508212740	62
			5773000	0508202610	55		~	
RENAULT		PAGE			PAGE			
5075310	5010557734	49			56	BPW		PAGE
5075320	5010557731	49	5102500	0508212660	56	5721400	0508213890	63
5075330	5010302479	49	5778000	0508212610	56	5721500	0508213900	63
5075210	5010267871	49	5100900	0508212120	56	5721600	0508213880	63
5075220	5010488232	49	5103300	0508212670	56	5730100	0508213670	63
			5779000	0508212340	56		0508213560	63
						PAGE		
						5730200		
ASTRA		PAGE			PAGE			
5066410	98185331	50			57	BPW		PAGE
5066420	98185269	50	5778100	0508213360	57	5731100	0508214020	64
			5778300	0508212680	57	5730400	0508214010	64
ASTRA		PAGE	5778700	0508202240	57			
6200000	98171415	51	5778800	0508202280	57			

Any reference to manufacture' s numbers are for the comparison purpose only. Alle Hersteller-Referenzen dien nur zu Vergleichswecken. Les references constructeur servent uniquement atitre d' indetification



5730500	0508213950	64	5102100	21204921	71	SAF		PAGE
5101650	0508213710	64	5102800		71	5861400	3149005700	78
5730600	0508214090	64				5861500	3155104800	78
			ROR		PAGE	5920000	3149003602	78
	BPW	PAGE	5104800	21215749	72	5890000	3149001203	78
5730050	0508213180	65	5101300	21222247	72	5890100	3149000302	78
5730800	0508213751	65	5101310	21221334	72			
5730700	0508213960	65	5101320	21222118	72	FREUHAUF		PAGE
5730900	0508213950	65	5105400	21215600	72	5102200	16058000	79
						5102350	UJA0895002	79
	SCHMITZ	PAGE	ROR		PAGE	5102300	460108	79
5104700	015156	66	5104740	099651/00	73			
5104720	014852	66	5104830	SR10-BP2-11G	73			PAGE
5104840	014896	66	5104820		73	5104920	2003101	80
5104850	015951	66	5105500	099142/00	73	5105600	2003105	80
5104750	FAG041-0072	66	6000009	887590/00	73	5104710	32090580	80
						5080160	ISUZU	80
	SCHMITZ	PAGE	TRAILER		PAGE	5104810	F01000518A	80
5104730	030030	67	5710000	790602/00	74			
5104950	266116/00	67	5710110	790605/00	74	FREIGHTLINER		PAGE
5104650	106227500	67	5104880	790652/00	74	5106100	1614463000	81
			5710100	790607/00	74	5106200	501566C92	81
	SCHMITZ	PAGE	5104600	F 124539	74	5106300	461432/00	81
5104860	016499	68					~	
5104910	266103/00	68	TRAILER		PAGE		~	
5104890	016501	68	5104500	6505240	75			
5104930	1023939	68	5104300	6505563P	75	FREIGHTLINER		PAGE
5104940	1042579	68	5104400	86987	75	5106700	46-1347	82
			5104870	6504765S	75	5106600	099783/00	82
	KASSBOHRER	PAGE				5106400	46-1255	82
5104000	8231223000	69				5106500	46-1253	82
5104100	8231123000	69	SAF		PAGE			
5100400	8231224000	69	5101100	3155103600	76			
5101200	699389/00	69	5861120	3149004001	76			
5931000	8241999240C	69	5861200	3155103602	76			
			5861300	3155104401	76			
	KASSBOHRER	PAGE	5861110	3155102802	76			
5931100	8231282100	70						
5931200	8231283100	70	SAF		PAGE			
			5102000	3149004101	77			
	ROR	PAGE	5890200	3155101401	77			
5100200	21200891	71	5861100	3149003901	77			
5100300	21017560	71	5861000	3149004200	77			
5810000	21204279	71	5861130	3155102502	77			

Any reference to manufacture' s numbers are for the comparison purpose only. Alle Hersteller-Referenzen dien nur zu Vergleichswecken. Les references constructeur servent uniquement atitre d' indetification



SEFERIADIS

LEAF SPRING FACTORY

MAIN OFFICE/ FACTORY:

12th klm ALEX/POLIS - FERES

GR 681 00 ALEXANDROUPOLIS - GREECE

tel.: +30 25510 51251

fax: +30 25510 51128

seferiadis@hol.gr

www.seferiadis.gr