



MERCEDES

Catalogue Reference

WEWELER-COLAERT

tel. +32 57 346 222 / +32 57 346 227

fax. +32 57 346 208

Beneluxlaan 1-3 B 8970 Poperinge - Belgium

info@colaert.be



MERCEDES : Catalogue Reference

- 1 -index
- 2 -info
- 3 -vormen - formes -
shapes - Formen
- 4 -index types
- 5 -catalogus - catalogue
Katalog
- 6 -veerstroppen - brides
U-bolts - Federbriden
- 7 -toebehoren - accessoires
Zubehör

Alle gegevens vermeld in deze catalogus werden zorgvuldig verzameld . Wij kunnen geen schadevergoedingen aanvaarden voor eventuele foutieve weergaven .

Toutes les données ont été assemblées soigneusement . Nous ne pouvons pas accepter des recours en indemnisation résultants d'une faute d'inadvertance commise lors de l'établissement du catalogue .

All data were carefully compiled . We cannot accept any claims for compensation due to errors inadvertently made in this catalogue .

Alle Daten wurden sorgfältig erarbeitet . Ersatzansprüche aufgrund von Angaben in diesem Katalog können nicht anerkannt werden .

NL Afkortingen

Voor	: voorveer
A/H	: achter-/hoofdveer + hulpveer
Achter	: achterveer
H	: hulpveer
Bladen	: aantal bladen
BR	: breedte
B	: lengte voor
C	: lengte achter
D1	: busdiam voor
D2	: busdiam achter
R	: oog zonder bus
D....	: draadbus
N....	: nylonbus
P....	: shackle pin
S....	: silentbloc
PH	: pijlhoogte
PAK	: pakketdikte

F Abbreviations

Voor	: ressort avant
A/H	: ressort principal/arrière + auxiliaire
Achter	: ressort arrière
H	: ressort auxiliaire
Lames	: nombre de lames
LRG	: largeur
B	: longueur avant
C	: longueur arrière
D1	: diamètre intérieur des douilles, av.
D2	: diamètre intérieur des douilles, ar.
R	: rouleau sans douille
D....	: rouleau avec bague filetée
N....	: rouleau avec bague nylon
P....	: shackle pin
S....	: silentbloc
FL	: flèche à vide
EP	: épaisseur du paquet

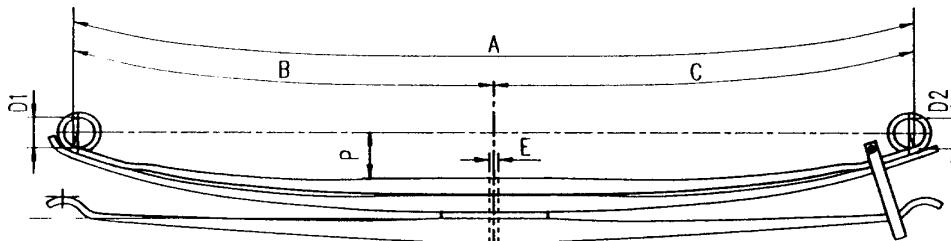

GB Abbreviations

Voor	: front spring
A/H	: main/rear spring + helper
Achter	: rear spring
H	: helper
Leaves	: number of leaves
WID	: width
B	: length front
C	: length rear
D1	: inside diam of front bushes
D2	: inside diam of rear bushes
R	: eye without bush
D....	: threaded bushing
N....	: nylon bushing
P....	: shackle pin
S....	: silentbloc
FA	: free arch
TH	: total height

D Kurzbezeichnungen

Voor	: Vorderfeder
A/H	: Hinter-/Hauptfeder + Zusatzfeder
Achter	: Hinterfeder
H	: Zusatzfeder
Blatt.	: Blattzahl
BR	: Breite
B	: Länge vorne
C	: Länge hinten
D1	: Büchsen diam innen vorne
D2	: Büchsen diam innen hinten
R	: Rolle ohne Büchsen
D....	: Gewinde Büchsen
N....	: Nylon Büchsen
P....	: Shackle pin
S....	: Silentbloc
SP	: Sprengung unbelastet
PAK	: Paketdicke

A01

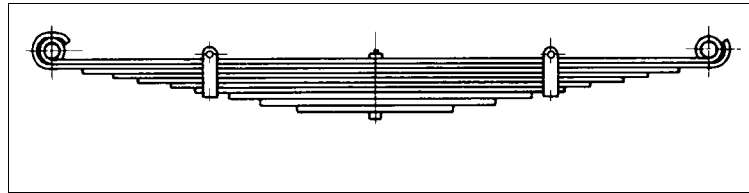

A01.10

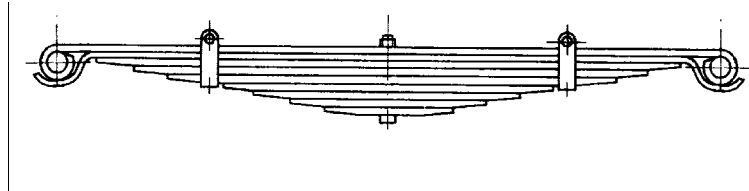

A01.16

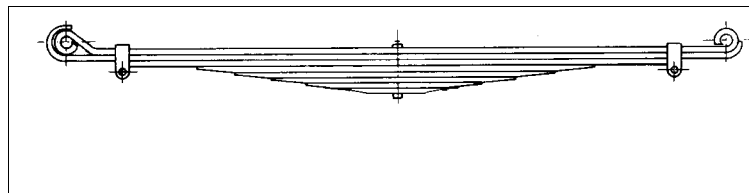

A01.17

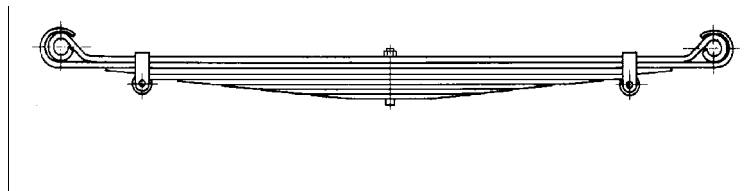

A01.20

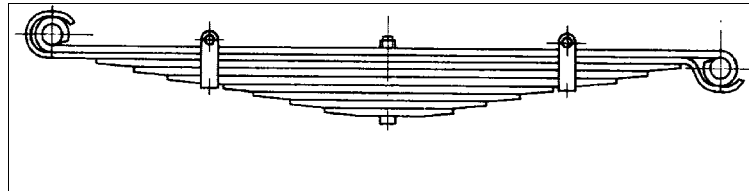

A01.60

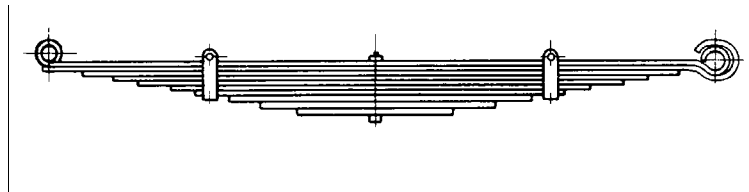

A01.70

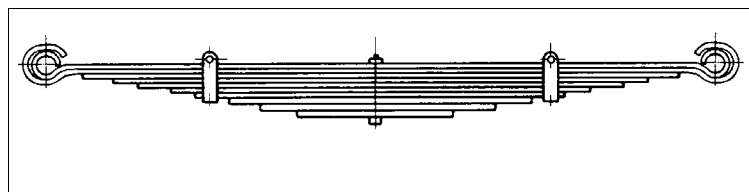

A01A

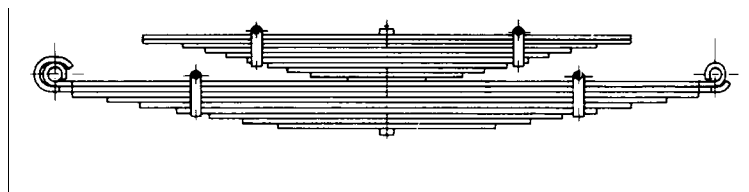

A01A.17

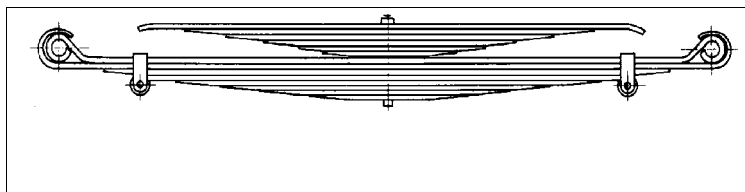

A01A.70

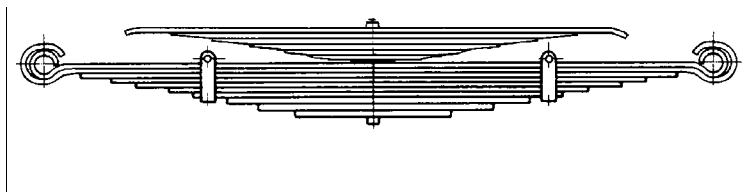

A01B

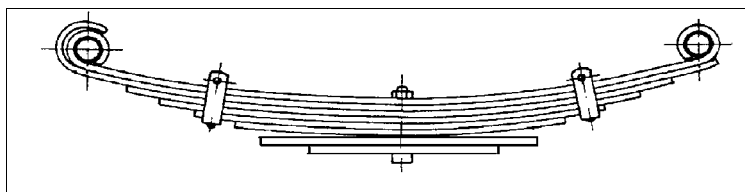

A01B.17

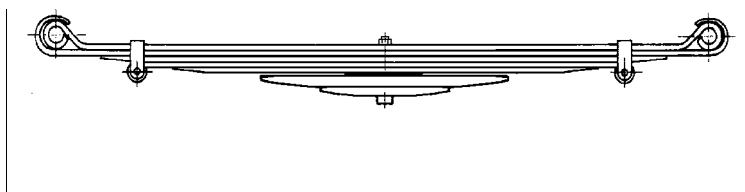

A01B.60

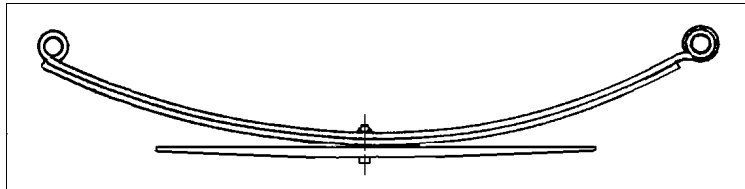

A01B.70

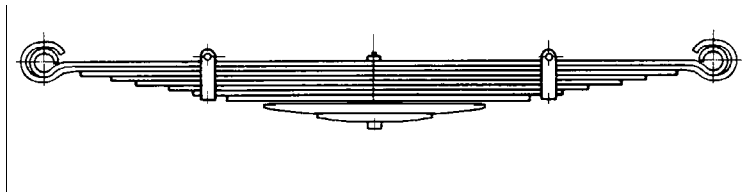

A01C

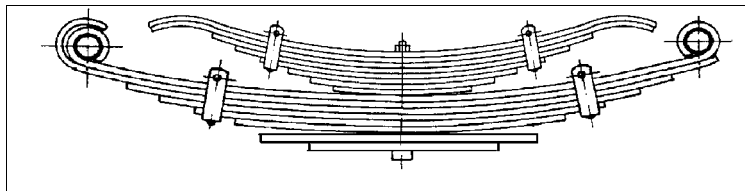

A03.13

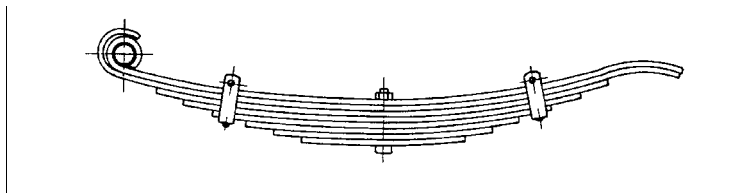

A03A.13

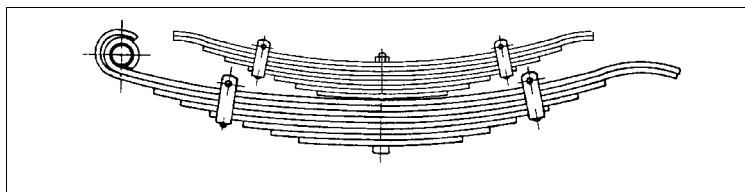

A03t

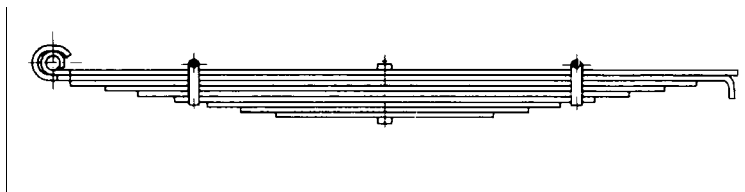

A08

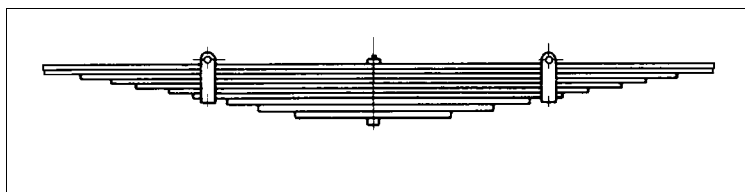

A08.09

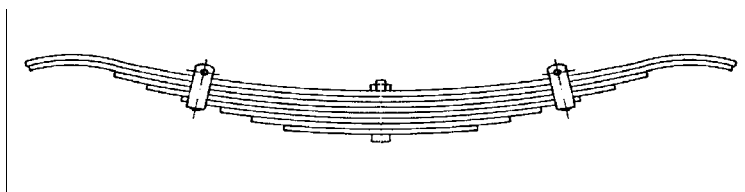

A08R

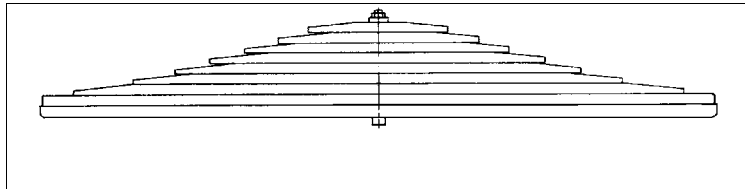

F01

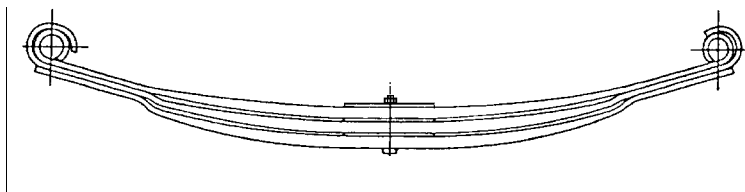

F01.10

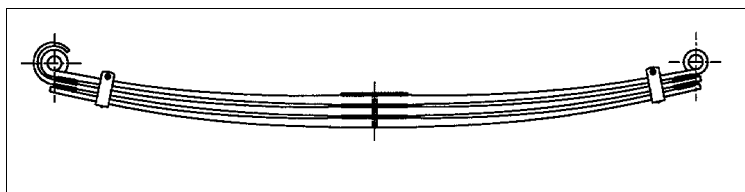

F01.13

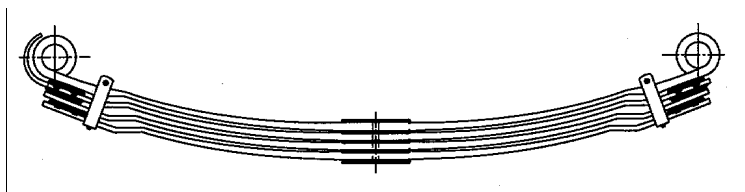

F01.20

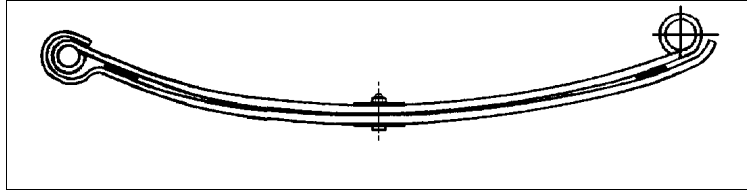

F01.22

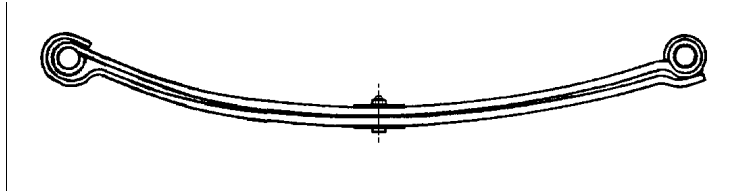

F01.70

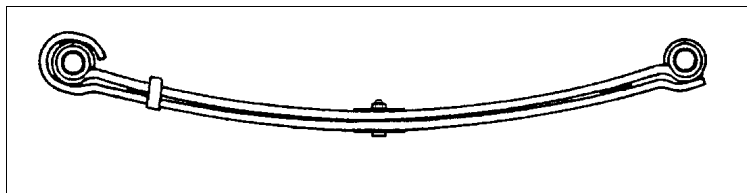

F01A

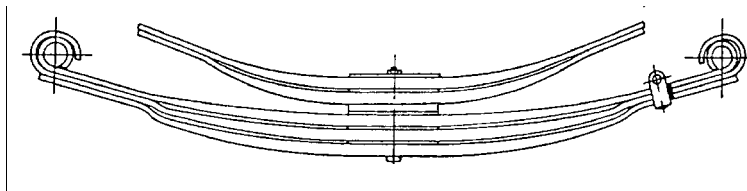

F01B

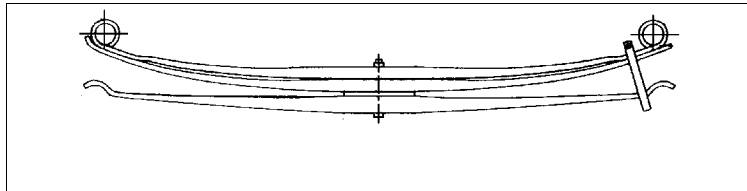

F01B.70

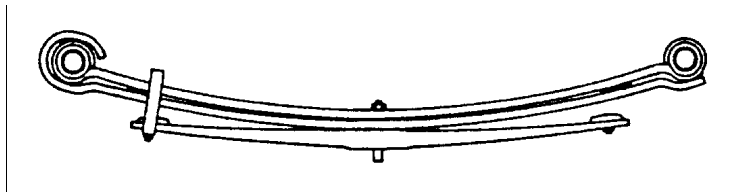

F03

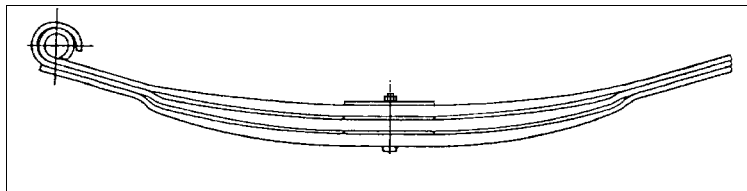

F08

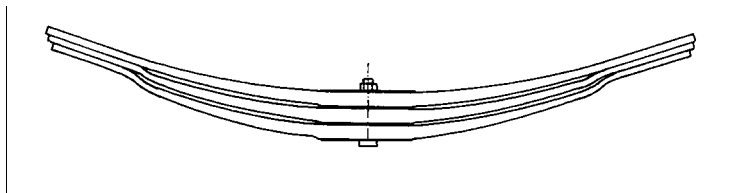

F08R

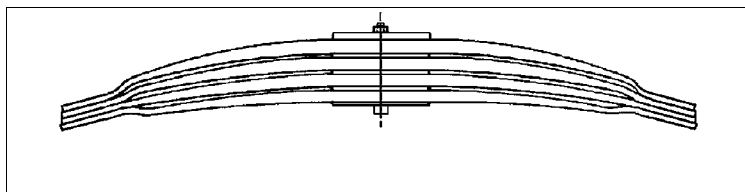

F08RB

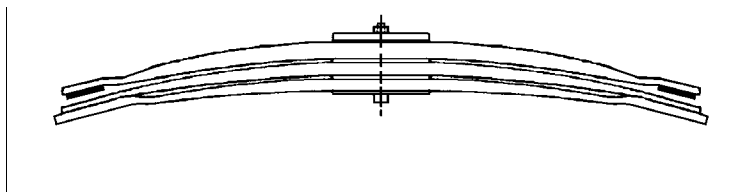

F08T1

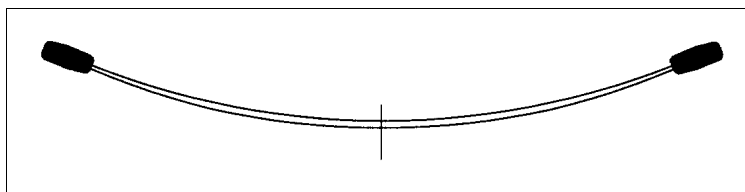

F08T2

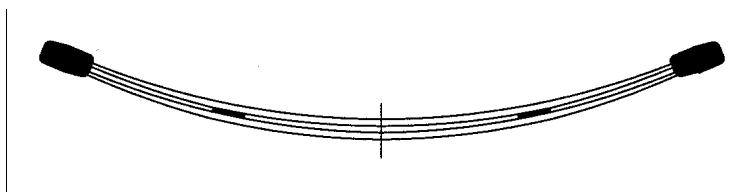

F54

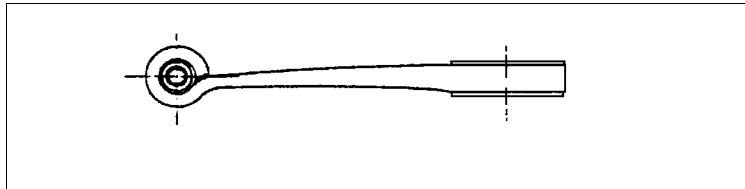

F74.01

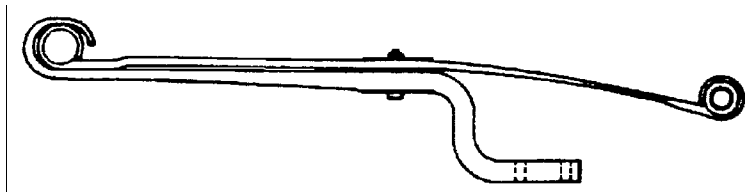

F74.04

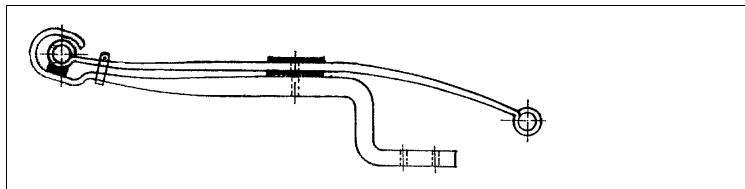

F74.05

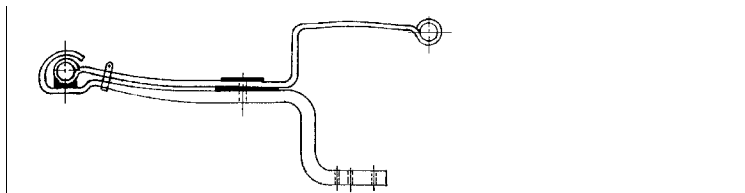

F74.61

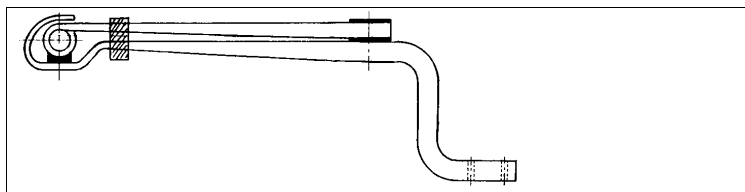

LR7811

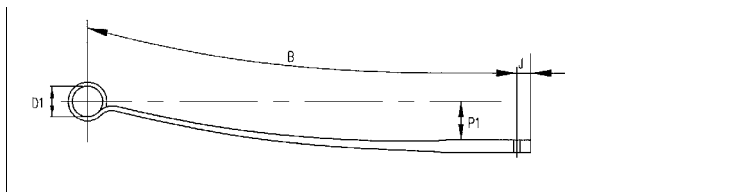

Index types

Serie

MERCEDES

-

ACTROS

ATEGO

DAIMLER-CHRY

SPRINTER 200

SPRINTER 300

SPRINTER 400

SPRINTER 600

BESTELNR N° COMMANDE ORDER NR BESTELNR	BR LRG WID BR	BLADEN LAMES LEAVES BLATT.	B	C	D1	D2	PH FL FA SP	PAK EP TH PAK	DETAIL	MOD	OPMERKINGEN REMARQUES REMARKS BEMERKUNGEN
---	------------------------	-------------------------------------	---	---	----	----	----------------------	------------------------	--------	-----	--

SERIE : -**207****voor-avant-front-Vorne**

F020T395ZA75	60	2	610	690	S12	S12		0		F01.10	
F020T301ZA75	60	2	610	690	S12	S12	185	28	2/14	F01.10	glijdop/pastille

achter-arrière-rear-Hinten

A020T398ZA75	60	2/1	740	810	S12	S12	175	41	2/11+1/19	A01.60	silentbloc
A020T404ZA75	60	2/1	740	810	S12	S12	170	37	2/11+1/15	A01.60	Silentbloc
A020T492ZA75	60	2/1	740	800	S12	S12	190	41	2/11+1/19	A01B.60	silentbloc
A020T476ZA75	60	3/1	740	803	S12	S12	190	53	3/10+1/23	A01B.60	silentbloc
A020T512ZA75	60	2/1	740	805	S12	S12	187	37	2/11+1/15	A01B.60	Silentbloc
A020T450ZA75	60	2/1	740	810	S12	S12	166	41	2/11+1/19	A01B.60	Silentbloc
A020T342ZA75	60	2/1	740	810	S12	S12	165	37	2/11+1/15	A01B.60	Silentbloc
A020T490ZA75	60	2/1	740	810	S12	S12	180	37	2/11+1/15	A01B.60	silentbloc
A020T474ZA75	60	3/1	740	810	S12	S12	190	53	3/10+1/23	A01B.60	Silentbloc
A020T334ZA75	60	3/1	740	810	S12	S12	177	51	3/10+1/21	A01B.60	Silentbloc
A020T330ZA75	60	3/1	740	810	S12	S12	175	53	3/10+1/23	A01B.60	Silentbloc

BESTELNR N° COMMANDE ORDER NR BESTELNR	BR LRG WID BR	BLADEN LAMES LEAVES BLATT.	B	C	D1	D2	PH FL FA SP	PAK EP TH PAK	DETAIL	MOD	OPMERKINGEN REMARQUES REMARKS BEMERKUNGEN
---	------------------------	-------------------------------------	---	---	----	----	----------------------	------------------------	--------	-----	--

SERIE : -**208****voor-avant-front-Vorne**

F020T395ZA75	60	2	610	690	S12	S12		0		F01.10	
F020T301ZA75	60	2	610	690	S12	S12	185	28	2/14	F01.10	glijdop/pastille

achter-arrière-rear-Hinten

A020T398ZA75	60	2/1	740	810	S12	S12	175	41	2/11+1/19	A01.60	silentbloc
A020T404ZA75	60	2/1	740	810	S12	S12	170	37	2/11+1/15	A01.60	Silentbloc
A020T492ZA75	60	2/1	740	800	S12	S12	190	41	2/11+1/19	A01B.60	silentbloc
A020T476ZA75	60	3/1	740	803	S12	S12	190	53	3/10+1/23	A01B.60	silentbloc
A020T512ZA75	60	2/1	740	805	S12	S12	187	37	2/11+1/15	A01B.60	Silentbloc
A020T450ZA75	60	2/1	740	810	S12	S12	166	41	2/11+1/19	A01B.60	Silentbloc
A020T342ZA75	60	2/1	740	810	S12	S12	165	37	2/11+1/15	A01B.60	Silentbloc
A020T490ZA75	60	2/1	740	810	S12	S12	180	37	2/11+1/15	A01B.60	silentbloc
A020T330ZA75	60	3/1	740	810	S12	S12	175	53	3/10+1/23	A01B.60	Silentbloc
A020T334ZA75	60	3/1	740	810	S12	S12	177	51	3/10+1/21	A01B.60	Silentbloc
A020T474ZA75	60	3/1	740	810	S12	S12	190	53	3/10+1/23	A01B.60	Silentbloc

209**voor-avant-front-Vorne**

F020T395ZA75	60	2	610	690	S12	S12		0		F01.10	
F020T301ZA75	60	2	610	690	S12	S12	185	28	2/14	F01.10	glijdop/pastille

achter-arrière-rear-Hinten

A020T492ZA75	60	2/1	740	800	S12	S12	190	41	2/11+1/19	A01B.60	silentbloc
A020T476ZA75	60	3/1	740	803	S12	S12	190	53	3/10+1/23	A01B.60	silentbloc
A020T512ZA75	60	2/1	740	805	S12	S12	187	37	2/11+1/15	A01B.60	Silentbloc
A020T490ZA75	60	2/1	740	810	S12	S12	180	37	2/11+1/15	A01B.60	silentbloc
A020T474ZA75	60	3/1	740	810	S12	S12	190	53	3/10+1/23	A01B.60	Silentbloc
A020T334ZA75	60	3/1	740	810	S12	S12	177	51	3/10+1/21	A01B.60	Silentbloc
A020T330ZA75	60	3/1	740	810	S12	S12	175	53	3/10+1/23	A01B.60	Silentbloc

BESTELNR N° COMMANDE ORDER NR BESTELNR	BR LRG WID BR	BLADEN LAMES LEAVES BLATT.	B	C	D1	D2	PH FL FA SP	PAK EP TH PAK	DETAIL	MOD	OPMERKINGEN REMARQUES REMARKS BEMERKUNGEN
---	------------------------	-------------------------------------	---	---	----	----	----------------------	------------------------	--------	-----	--

SERIE : -**210****voor-avant-front-Vorne**

F020T395ZA75	60	2	610	690	S12	S12		0		F01.10	
F020T301ZA75	60	2	610	690	S12	S12	185	28	2/14	F01.10	glijdop/pastille

achter-arrière-rear-Hinten

A020T398ZA75	60	2/1	740	810	S12	S12	175	41	2/11+1/19	A01.60	silentbloc
A020T404ZA75	60	2/1	740	810	S12	S12	170	37	2/11+1/15	A01.60	Silentbloc
A020T492ZA75	60	2/1	740	800	S12	S12	190	41	2/11+1/19	A01B.60	silentbloc
A020T476ZA75	60	3/1	740	803	S12	S12	190	53	3/10+1/23	A01B.60	silentbloc
A020T512ZA75	60	2/1	740	805	S12	S12	187	37	2/11+1/15	A01B.60	Silentbloc
A020T490ZA75	60	2/1	740	810	S12	S12	180	37	2/11+1/15	A01B.60	silentbloc
A020T450ZA75	60	2/1	740	810	S12	S12	166	41	2/11+1/19	A01B.60	Silentbloc
A020T342ZA75	60	2/1	740	810	S12	S12	165	37	2/11+1/15	A01B.60	Silentbloc
A020T330ZA75	60	3/1	740	810	S12	S12	175	53	3/10+1/23	A01B.60	Silentbloc
A020T334ZA75	60	3/1	740	810	S12	S12	177	51	3/10+1/21	A01B.60	Silentbloc
A020T474ZA75	60	3/1	740	810	S12	S12	190	53	3/10+1/23	A01B.60	Silentbloc

BESTELNR N° COMMANDE ORDER NR BESTELNR	BR LRG WID BR	BLADEN LAMES LEAVES BLATT.	B	C	D1	D2	PH FL FA SP	PAK EP TH PAK	DETAIL	MOD	OPMERKINGEN REMARQUES REMARKS BEMERKUNGEN
---	------------------------	-------------------------------------	---	---	----	----	----------------------	------------------------	--------	-----	--

SERIE : -**307****voor-avant-front-Vorne**

F020T301ZA75	60	2	610	690	S12	S12	185	28	2/14	F01.10	glijdop/pastille
F020T593ZA75	60	2	610	690	S12	S12	165	30	2/15	F01.10	
F020T483ZA75	60	2	610	690	S12	S12	180	30	2/15	F01.10	glijdop/pastille
F020T439ZA75	60	3	610	690	S12	S12	160	39	3/13	F01.10	glijdop/pastille

achter-arrière-rear-Hinten

A020T476ZA75	60	3/1	740	803	S12	S12	190	53	3/10+1/23	A01B.60	silentbloc
A020T500ZA75	60	3/1	740	805	S12	S12	201	50	3/10+1/20	A01B.60	silentbloc
A020T474ZA75	60	3/1	740	810	S12	S12	190	53	3/10+1/23	A01B.60	Silentbloc
A020T344ZA75	60	3/1	740	810	S12	S12	190	51	3/10+1/21	A01B.60	Silentbloc
A020T334ZA75	60	3/1	740	810	S12	S12	177	51	3/10+1/21	A01B.60	Silentbloc
A020T330ZA75	60	3/1	740	810	S12	S12	175	53	3/10+1/23	A01B.60	Silentbloc
A020T230ZA75	60	3/1	740	810	S12	S12	177	51	3/10+1/21	A01B.60	silentbloc
A020T280ZA75	60	3/1	740	812	S12	S12	132	54	3/10+1/24	A01B.60	Silentbloc

308**voor-avant-front-Vorne**

F020T593ZA75	60	2	610	690	S12	S12	165	30	2/15	F01.10	
F020T483ZA75	60	2	610	690	S12	S12	180	30	2/15	F01.10	glijdop/pastille
F020T301ZA75	60	2	610	690	S12	S12	185	28	2/14	F01.10	glijdop/pastille
F020T439ZA75	60	3	610	690	S12	S12	160	39	3/13	F01.10	glijdop/pastille

achter-arrière-rear-Hinten

A020T476ZA75	60	3/1	740	803	S12	S12	190	53	3/10+1/23	A01B.60	silentbloc
A020T500ZA75	60	3/1	740	805	S12	S12	201	50	3/10+1/20	A01B.60	silentbloc
A020T330ZA75	60	3/1	740	810	S12	S12	175	53	3/10+1/23	A01B.60	Silentbloc
A020T334ZA75	60	3/1	740	810	S12	S12	177	51	3/10+1/21	A01B.60	Silentbloc
A020T230ZA75	60	3/1	740	810	S12	S12	177	51	3/10+1/21	A01B.60	silentbloc
A020T474ZA75	60	3/1	740	810	S12	S12	190	53	3/10+1/23	A01B.60	Silentbloc
A020T344ZA75	60	3/1	740	810	S12	S12	190	51	3/10+1/21	A01B.60	Silentbloc
A020T280ZA75	60	3/1	740	812	S12	S12	132	54	3/10+1/24	A01B.60	Silentbloc

BESTELNR N° COMMANDE ORDER NR BESTELNR	BR LRG WID BR	BLADEN LAMES LEAVES BLATT.	B	C	D1	D2	PH FL FA SP	PAK EP TH PAK	DETAIL	MOD	OPMERKINGEN REMARQUES REMARKS BEMERKUNGEN
---	------------------------	-------------------------------------	---	---	----	----	----------------------	------------------------	--------	-----	--

SERIE : -**309****voor-avant-front-Vorne**

F020T301ZA75	60	2	610	690	S12	S12	185	28	2/14	F01.10	glijdop/pastille
F020T593ZA75	60	2	610	690	S12	S12	165	30	2/15	F01.10	
F020T483ZA75	60	2	610	690	S12	S12	180	30	2/15	F01.10	glijdop/pastille
F020T439ZA75	60	3	610	690	S12	S12	160	39	3/13	F01.10	glijdop/pastille

achter-arrière-rear-Hinten

A020T492ZA75	60	2/1	740	800	S12	S12	190	41	2/11+1/19	A01B.60	silentbloc
A020T476ZA75	60	3/1	740	803	S12	S12	190	53	3/10+1/23	A01B.60	silentbloc
A020T500ZA75	60	3/1	740	805	S12	S12	201	50	3/10+1/20	A01B.60	silentbloc
A020T280ZA75	60	3/1	740	812	S12	S12	132	54	3/10+1/24	A01B.60	Silentbloc

310**voor-avant-front-Vorne**

F020T301ZA75	60	2	610	690	S12	S12	185	28	2/14	F01.10	glijdop/pastille
F020T483ZA75	60	2	610	690	S12	S12	180	30	2/15	F01.10	glijdop/pastille
F020T593ZA75	60	2	610	690	S12	S12	165	30	2/15	F01.10	
F020T439ZA75	60	3	610	690	S12	S12	160	39	3/13	F01.10	glijdop/pastille

achter-arrière-rear-Hinten

A020T492ZA75	60	2/1	740	800	S12	S12	190	41	2/11+1/19	A01B.60	silentbloc
A020T476ZA75	60	3/1	740	803	S12	S12	190	53	3/10+1/23	A01B.60	silentbloc
A020T500ZA75	60	3/1	740	805	S12	S12	201	50	3/10+1/20	A01B.60	silentbloc
A020T344ZA75	60	3/1	740	810	S12	S12	190	51	3/10+1/21	A01B.60	Silentbloc
A020T474ZA75	60	3/1	740	810	S12	S12	190	53	3/10+1/23	A01B.60	Silentbloc
A020T330ZA75	60	3/1	740	810	S12	S12	175	53	3/10+1/23	A01B.60	Silentbloc
A020T230ZA75	60	3/1	740	810	S12	S12	177	51	3/10+1/21	A01B.60	silentbloc
A020T334ZA75	60	3/1	740	810	S12	S12	177	51	3/10+1/21	A01B.60	Silentbloc
A020T280ZA75	60	3/1	740	812	S12	S12	132	54	3/10+1/24	A01B.60	Silentbloc

BESTELNR N° COMMANDE ORDER NR BESTELNR	BR LRG WID BR	BLADEN LAMES LEAVES BLATT.	B	C	D1	D2	PH FL FA SP	PAK EP TH PAK	DETAIL	MOD	OPMERKINGEN REMARQUES REMARKS BEMERKUNGEN
---	------------------------	-------------------------------------	---	---	----	----	----------------------	------------------------	--------	-----	--

SERIE : -

407

voor-avant-front-Vorne

F020T483ZA75	60	2	610	690	S12	S12	180	30	2/15	F01.10	glijdop/pastille
F020T593ZA75	60	2	610	690	S12	S12	165	30	2/15	F01.10	
F020T439ZA75	60	3	610	690	S12	S12	160	39	3/13	F01.10	glijdop/pastille

achter-arrière-rear-Hinten

A020T472ZA75	70	4/1	870	790	S16	S16	155	70	4/10,5+1/28	A01B.60	Silentbloc
A020T444ZA75	70	4/1	870	790	S16	S16	155	68	4/10+1/28	A01B.60	Silentbloc

408

voor-avant-front-Vorne

F020T593ZA75	60	2	610	690	S12	S12	165	30	2/15	F01.10	
F020T483ZA75	60	2	610	690	S12	S12	180	30	2/15	F01.10	glijdop/pastille
F020T439ZA75	60	3	610	690	S12	S12	160	39	3/13	F01.10	glijdop/pastille

achter-arrière-rear-Hinten

A020T472ZA75	70	4/1	870	790	S16	S16	155	70	4/10,5+1/28	A01B.60	Silentbloc
A020T444ZA75	70	4/1	870	790	S16	S16	155	68	4/10+1/28	A01B.60	Silentbloc

409

voor-avant-front-Vorne

F020T593ZA75	60	2	610	690	S12	S12	165	30	2/15	F01.10	
F020T483ZA75	60	2	610	690	S12	S12	180	30	2/15	F01.10	glijdop/pastille
F020T439ZA75	60	3	610	690	S12	S12	160	39	3/13	F01.10	glijdop/pastille

achter-arrière-rear-Hinten

A020T444ZA75	70	4/1	870	790	S16	S16	155	68	4/10+1/28	A01B.60	Silentbloc
A020T472ZA75	70	4/1	870	790	S16	S16	155	70	4/10,5+1/28	A01B.60	Silentbloc

BESTELNR N° COMMANDE ORDER NR BESTELNR	BR LRG WID BR	BLADEN LAMES LEAVES BLATT.	B	C	D1	D2	PH FL FA SP	PAK EP TH PAK	DETAIL	MOD	OPMERKINGEN REMARQUES REMARKS BEMERKUNGEN
---	------------------------	-------------------------------------	---	---	----	----	----------------------	------------------------	--------	-----	--

SERIE : -

410

voor-avant-front-Vorne

F020T593ZA75	60	2	610	690	S12	S12	165	30	2/15	F01.10	
F020T483ZA75	60	2	610	690	S12	S12	180	30	2/15	F01.10	glijdop/pastille
F020T439ZA75	60	3	610	690	S12	S12	160	39	3/13	F01.10	glijdop/pastille

achter-arrière-rear-Hinten

A020T472ZA75	70	4/1	870	790	S16	S16	155	70	4/10,5+1/28	A01B.60	Silentbloc
A020T444ZA75	70	4/1	870	790	S16	S16	155	68	4/10+1/28	A01B.60	Silentbloc

507

voor-avant-front-Vorne

F020T579AA75	70	2	660	772	R42	R42	248	37	2/14	F01.20	glijdop/pastille
F020T579ZA75	70	2	660	772	R42	R42	236	37	2/14	F01.20	glijdop/pastille
F020T481AA75	70	2/P	660	890	R42	R42	171	54	2/16+P/16	F01.20	glijdop/pastille
F020T481ZA75	70	2/P	660	890	R42	R42	159	54	2/16+P/16	F01.20	glijdop/pastille

achter-arrière-rear-Hinten

F020T564ZA75	70	2/1	790	790	R42	S30	150	63	2/12+1/30	F01B	glijdop/pastille
F020T504ZA75	70	2/1	790	790	R42	S30	139	60	2/12+1/27	F01B	glijdop/pastille
F020T516ZA75	70	3/1	790	790	S30	S30	178	78	3/12+1/30	F01B	glijdop/pastille
F020T516AA75	70	3/1	790	790	S30	S30	178	78	3/12+1/30	F01B	glijdop/pastille

BESTELNR N° COMMANDE ORDER NR BESTELNR	BR LRG WID BR	BLADEN LAMES LEAVES BLATT.	B	C	D1	D2	PH FL FA SP	PAK EP TH PAK	DETAIL	MOD	OPMERKINGEN REMARQUES REMARKS BEMERKUNGEN
---	------------------------	-------------------------------------	---	---	----	----	----------------------	------------------------	--------	-----	--

SERIE : -

508

voor-avant-front-Vorne

F020T579AA75	70	2	660	772	R42	R42	248	37	2/14	F01.20	glijdop/pastille
F020T579ZA75	70	2	660	772	R42	R42	236	37	2/14	F01.20	glijdop/pastille
F020T481ZA75	70	2/P	660	890	R42	R42	159	54	2/16+P/16	F01.20	glijdop/pastille
F020T481AA75	70	2/P	660	890	R42	R42	171	54	2/16+P/16	F01.20	glijdop/pastille

achter-arrière-rear-Hinten

F020T504ZA75	70	2/1	790	790	R42	S30	139	60	2/12+1/27	F01B	glijdop/pastille
F020T564ZA75	70	2/1	790	790	R42	S30	150	63	2/12+1/30	F01B	glijdop/pastille
F020T516AA75	70	3/1	790	790	S30	S30	178	78	3/12+1/30	F01B	glijdop/pastille
F020T516ZA75	70	3/1	790	790	S30	S30	178	78	3/12+1/30	F01B	glijdop/pastille

510

voor-avant-front-Vorne

F020T579AA75	70	2	660	772	R42	R42	248	37	2/14	F01.20	glijdop/pastille
F020T579ZA75	70	2	660	772	R42	R42	236	37	2/14	F01.20	glijdop/pastille
F020T481AA75	70	2/P	660	890	R42	R42	171	54	2/16+P/16	F01.20	glijdop/pastille
F020T481ZA75	70	2/P	660	890	R42	R42	159	54	2/16+P/16	F01.20	glijdop/pastille

achter-arrière-rear-Hinten

F020T504ZA75	70	2/1	790	790	R42	S30	139	60	2/12+1/27	F01B	glijdop/pastille
F020T564ZA75	70	2/1	790	790	R42	S30	150	63	2/12+1/30	F01B	glijdop/pastille
F020T516AA75	70	3/1	790	790	S30	S30	178	78	3/12+1/30	F01B	glijdop/pastille
F020T516ZA75	70	3/1	790	790	S30	S30	178	78	3/12+1/30	F01B	glijdop/pastille

BESTELNR N° COMMANDE ORDER NR BESTELNR	BR LRG WID BR	BLADEN LAMES LEAVES BLATT.	B	C	D1	D2	PH FL FA SP	PAK EP TH PAK	DETAIL	MOD	OPMERKINGEN REMARQUES REMARKS BEMERKUNGEN
---	------------------------	-------------------------------------	---	---	----	----	----------------------	------------------------	--------	-----	--

SERIE : -**609****voor-avant-front-Vorne**

F020T481ZA75	70	2/P	660	890	R42	R42	159	54	2/16+P/16	F01.20	glijdop/pastille
F020T481AA75	70	2/P	660	890	R42	R42	171	54	2/16+P/16	F01.20	glijdop/pastille
F020T565AA75	70	3	660	890	R42	R42	203	52	1/10+2/15	F01.20	glijdop/pastille
F020T565ZA75	70	3	660	890	R42	R42	190	52	1/10+2/15	F01.20	glijdop/pastille
F020T443ZA75	70	3	660	890	R42	R42	177	51	3/14	F01.20	glijdop/pastille
F020T443AA75	70	3	660	890	R42	R42	187	51	3/14	F01.20	glijdop/pastille

achter-arrière-rear-Hinten

F020T504ZA75	70	2/1	790	790	R42	S30	139	60	2/12+1/27	F01B	glijdop/pastille
F020T564ZA75	70	2/1	790	790	R42	S30	150	63	2/12+1/30	F01B	glijdop/pastille
F020T516ZA75	70	3/1	790	790	S30	S30	178	78	3/12+1/30	F01B	glijdop/pastille
F020T516AA75	70	3/1	790	790	S30	S30	178	78	3/12+1/30	F01B	glijdop/pastille
F020T510ZA75	70	3/1	790	790	S30	S30	161	83	1/12.5+2/12+1/34	F01B	glijdop/pastille
F020T510AA75	70	3/1	790	790	S30	S30	161	83	1/12.5+2/12+1/34	F01B	glijdop/pastille
F020T688ZA75	70	4/1	790	790	S30	S30	207	90	4/13.5+1/21	F01B	glijdop/pastille
F020T688AA75	70	4/1	790	790	S30	S30	207	90	4/13.5+1/21	F01B	glijdop/pastille

BESTELNR N° COMMANDE ORDER NR BESTELNR	BR LRG WID BR	BLADEN LAMES LEAVES BLATT.	B	C	D1	D2	PH FL FA SP	PAK EP TH PAK	DETAIL	MOD	OPMERKINGEN REMARQUES REMARKS BEMERKUNGEN
---	------------------------	-------------------------------------	---	---	----	----	----------------------	------------------------	--------	-----	--

SERIE : -**709****voor-avant-front-Vorne**

A020T435ZA75	80	6	800	800	S17	S17	162	66	6/11	A01.70	Silentbloc
F020T443ZA75	70	3	660	890	R42	R42	177	51	3/14	F01.20	glijdop/pastille
F020T565ZA75	70	3	660	890	R42	R42	190	52	1/10+2/15	F01.20	glijdop/pastille
F020T565AA75	70	3	660	890	R42	R42	203	52	1/10+2/15	F01.20	glijdop/pastille
F020T443AA75	70	3	660	890	R42	R42	187	51	3/14	F01.20	glijdop/pastille
F020T487ZA75	70	4	660	890	R42	R42	274	61	1/10+3/13	F01.20	glijdop/pastille
F020T487AA75	70	4	660	890	R42	R42	286	61	1/10+3/13	F01.20	glijdop/pastille
F020T525ZA75	80	2	800	800	S17	S17	180	44	2/19 - GA	F01.70	glijdop/pastille
F020T429ZA75	80	2	800	800	S17	S17	180	44	2/19	F01.70	Silentbloc

achter-arrière-rear-Hinten

A	A020T594ZA76	80	7/P/5	790	790	S36	S36	148	136		A01A.70	Silentbloc
	A020T594ZA75	80	7	790	790	S36	S36	148	77	7/11	A01.70	Silentbloc
H	A020T594HA80	80	5/P	600	600	--	--	100	59	5/10+P/9	A08	
	F020T510ZA75	70	3/1	790	790	S30	S30	161	83	1/12.5+2/12+1/34	F01B	glijdop/pastille
	F020T510AA75	70	3/1	790	790	S30	S30	161	83	1/12.5+2/12+1/34	F01B	glijdop/pastille
	F020T756AA75	70	3/1	790	790	S30	S30	116	94	3/14+1/40	F01B	glijdop/pastille
	F020T756ZA75	70	3/1	790	790	S30	S30		94	3/14+1/40	F01B	glijdop/pastille
	F020T542ZA75	70	3/1	790	790	S30	S30	164	87	3/12+1/36	F01B	glijdop/pastille
	F020T542AA75	70	3/1	790	790	S30	S30	164	87	3/12+1/36	F01B	glijdop/pastille
	F020T688ZA75	70	4/1	790	790	S30	S30	207	90	4/13.5+1/21	F01B	glijdop/pastille
	F020T688AA75	70	4/1	790	790	S30	S30	207	90	4/13.5+1/21	F01B	glijdop/pastille
	F020T672ZA75	70	4/1	790	790	S30	S30	188	85	4/15,5+1/21	F01B	glijdop/pastille
	F020T672AA75	70	4/1	790	790	S30	S30	188	85	4/15,5+1/21	F01B	glijdop/pastille
	F020T526ZA75	80	2/1	790	790	S36	S36	133	71	2/14+1/34	F01B.70	glijdop/pastille
	F020T578ZA75	80	2/1	790	790	S36	S36	130	71	2/14+1/34 - GA	F01B.70	glijdop/pastille

BESTELNR N° COMMANDE ORDER NR BESTELNR	BR LRG WID BR	BLADEN LAMES LEAVES BLATT.	B	C	D1	D2	PH FL FA SP	PAK EP TH PAK	DETAIL	MOD	OPMERKINGEN REMARKES REMARKS BEMERKUNGEN
---	------------------------	-------------------------------------	---	---	----	----	----------------------	------------------------	--------	-----	---

SERIE : -**711****voor-avant-front-Vorne**

F020T481ZA75	70	2/P	660	890	R42	R42	159	54	2/16+P/16	F01.20	glijdop/pastille
F020T481AA75	70	2/P	660	890	R42	R42	171	54	2/16+P/16	F01.20	glijdop/pastille
F020T443AA75	70	3	660	890	R42	R42	187	51	3/14	F01.20	glijdop/pastille
F020T565AA75	70	3	660	890	R42	R42	203	52	1/10+2/15	F01.20	glijdop/pastille
F020T719ZA75	70	3	660	890	R42	R42			1/16+2/18	F01.20	
F020T719AA75	70	3	660	890	R42	R42			1/16+2/18	F01.20	
F020T565ZA75	70	3	660	890	R42	R42	190	52	1/10+2/15	F01.20	glijdop/pastille
F020T443ZA75	70	3	660	890	R42	R42	177	51	3/14	F01.20	glijdop/pastille
F020T487AA75	70	4	660	890	R42	R42	286	61	1/10+3/13	F01.20	glijdop/pastille
F020T487ZA75	70	4	660	890	R42	R42	274	61	1/10+3/13	F01.20	glijdop/pastille

achter-arrière-rear-Hinten

F020T756ZA75	70	3/1	790	790	S30	S30		94	3/14+1/40	F01B	glijdop/pastille
F020T510ZA75	70	3/1	790	790	S30	S30	161	83	1/12.5+2/12+1/34	F01B	glijdop/pastille
F020T542ZA75	70	3/1	790	790	S30	S30	164	87	3/12+1/36	F01B	glijdop/pastille
F020T510AA75	70	3/1	790	790	S30	S30	161	83	1/12.5+2/12+1/34	F01B	glijdop/pastille
F020T756AA75	70	3/1	790	790	S30	S30	116	94	3/14+1/40	F01B	glijdop/pastille
F020T542AA75	70	3/1	790	790	S30	S30	164	87	3/12+1/36	F01B	glijdop/pastille
F020T672ZA75	70	4/1	790	790	S30	S30	188	85	4/15,5+1/21	F01B	glijdop/pastille
F020T672AA75	70	4/1	790	790	S30	S30	188	85	4/15,5+1/21	F01B	glijdop/pastille
F020T688AA75	70	4/1	790	790	S30	S30	207	90	4/13.5+1/21	F01B	glijdop/pastille
F020T688ZA75	70	4/1	790	790	S30	S30	207	90	4/13.5+1/21	F01B	glijdop/pastille

BESTELNR N° COMMANDE ORDER NR BESTELNR	BR LRG WID BR	BLADEN LAMES LEAVES BLATT.	B	C	D1	D2	PH FL FA SP	PAK EP TH PAK	DETAIL	MOD	OPMERKINGEN REMARQUES REMARKS BEMERKUNGEN
---	------------------------	-------------------------------------	---	---	----	----	----------------------	------------------------	--------	-----	--

SERIE : -

809

voor-avant-front-Vorne

A020T435ZA75	80	6	800	800	S17	S17	162	66	6/11	A01.70	Silentbloc
A020T563ZA75	80	6	800	920	S17	S17	155	78	6/13	A01.70	Silentbloc
F020T719AA75	70	3	660	890	R42	R42			1/16+2/18	F01.20	
F020T719ZA75	70	3	660	890	R42	R42			1/16+2/18	F01.20	
F020T487ZA75	70	4	660	890	R42	R42	274	61	1/10+3/13	F01.20	glijdop/pastille
F020T487AA75	70	4	660	890	R42	R42	286	61	1/10+3/13	F01.20	glijdop/pastille
F020T577ZA75	70	4	660	890	R42	R42	272	64	1/10+3/14	F01.20	glijdop/pastille
F020T577AA75	70	4	660	890	R42	R42	284	64	1/10+3/14	F01.20	glijdop/pastille
F020T429ZA75	80	2	800	800	S17	S17	180	44	2/19	F01.70	Silentbloc
F020T525ZA75	80	2	800	800	S17	S17	180	44	2/19 - GA	F01.70	glijdop/pastille
F020T529ZA75	80	3	800	800	S17	S17	203	60	3/17 - GA	F01.70	glijdop/pastille
F020T527ZA75	80	3	800	800	S17	S17	176	60	3/17 - GA	F01.70	glijdop/pastille
F020T523ZA75	80	3	800	800	S17	S17	189	57	3/16 - GA	F01.70	glijdop/pastille
F020T473ZA75	80	3	800	800	S17	S17	176	60	3/17	F01.70	Silentbloc
F020T469ZA75	80	3	800	800	S17	S17	189	57	3/16	F01.70	Silentbloc
F020T471ZA75	80	3	800	800	S17	S17	203	60	3/17	F01.70	Silentbloc
F020T535ZA75	80	2	800	920	S17	S17	199	46	2/20 - GA	F01.70	glijdop/pastille
F020T533ZA75	80	2	800	920	S17	S17	180	48	2/21 - GA	F01.70	glijdop/pastille
F020T467ZA75	80	2	800	920	S17	S17	180	48	2/21	F01.70	Silentbloc

BESTELNR N° COMMANDE ORDER NR BESTELNR	BR LRG WID BR	BLADEN LAMES LEAVES BLATT.	B	C	D1	D2	PH FL FA SP	PAK EP TH PAK	DETAIL	MOD	OPMERKINGEN REMARKS REMARKS BEMERKUNGEN
---	------------------------	-------------------------------------	---	---	----	----	----------------------	------------------------	--------	-----	--

SERIE : -

809

achter-arrière-rear-Hinten

A	A020T778ZA76	80	8/P/5	790	790	S36	S36		147		A01A	
H	A020T778ZA75	80	8	790	790	S36	S36		88	8/11	A01	
H	A020T778HA80	80	5/P	600	600	--	--		59	5/10+P/9	A08	
A	A020T594ZA76	80	7/P/5	790	790	S36	S36	148	136		A01A.70	Silentbloc
H	A020T594ZA75	80	7	790	790	S36	S36	148	77	7/11	A01.70	Silentbloc
H	A020T594HA80	80	5/P	600	600	--	--	100	59	5/10+P/9	A08	
	F020T632ZA75	70	3/1	790	790	S36	S30	166	81	3/12+1/36	F01B	glijdop/pastille
	F020T786ZA75	70	3/2	790	790	S36	S30	120	122	3/14.5+2/33	F01B	glijdop/pastille
	F020T558ZA75	70	3/2	790	790	S36	S30	146	113	3/13,5+2/30	F01B	glijdop/pastille
	F020T798ZA75	80	2/1	790	790	S36	S36	142	73	2/14+1/36 - GA	F01B	Glijdop/Pastille
	F020T608ZA75	80	2/1	790	790	S36	S36	142	73	2/14+1/36	F01B.70	glijdop/pastille
	F020T606ZA75	80	2/1	790	790	S36	S36	135	75	2/15+1/36 - GA	F01B.70	glijdop/pastille
	F020T604ZA75	80	2/1	790	790	S36	S36	135	75	2/15+1/36 - GA	F01B.70	glijdop/pastille
	F020T578ZA75	80	2/1	790	790	S36	S36	130	71	2/14+1/34 - GA	F01B.70	glijdop/pastille
	F020T544ZA75	80	2/1	790	790	S36	S36	136	74	2/14,5+1/36	F01B.70	glijdop/pastille
	F020T526ZA75	80	2/1	790	790	S36	S36	133	71	2/14+1/34	F01B.70	glijdop/pastille
	F020T498ZA75	80	2/1	790	790	S36	S36	135	75	2/15+1/36	F01B.70	glijdop/pastille

811

voor-avant-front-Vorne

	F020T719ZA75	70	3	660	890	R42	R42			1/16+2/18	F01.20	
	F020T719AA75	70	3	660	890	R42	R42			1/16+2/18	F01.20	
	F020T577ZA75	70	4	660	890	R42	R42	272	64	1/10+3/14	F01.20	glijdop/pastille
	F020T487AA75	70	4	660	890	R42	R42	286	61	1/10+3/13	F01.20	glijdop/pastille
	F020T487ZA75	70	4	660	890	R42	R42	274	61	1/10+3/13	F01.20	glijdop/pastille
	F020T577AA75	70	4	660	890	R42	R42	284	64	1/10+3/14	F01.20	glijdop/pastille

achter-arrière-rear-Hinten

	F020T632ZA75	70	3/1	790	790	S36	S30	166	81	3/12+1/36	F01B	glijdop/pastille
	F020T670ZA75	70	4/1	790	790	S36	S30	168	102	4/15,5+1/25	F01B	glijdop/pastille
	F020T558ZA75	70	3/2	790	790	S36	S30	146	113	3/13,5+2/30	F01B	glijdop/pastille
	F020T786ZA75	70	3/2	790	790	S36	S30	120	122	3/14.5+2/33	F01B	glijdop/pastille
	F020T672ZA75	70	4/1	790	790	S30	S30	188	85	4/15,5+1/21	F01B	glijdop/pastille
	F020T672AA75	70	4/1	790	790	S30	S30	188	85	4/15,5+1/21	F01B	glijdop/pastille

BESTELNR N° COMMANDE ORDER NR BESTELNR	BR LRG WID BR	BLADEN LAMES LEAVES BLATT.	B	C	D1	D2	PH FL FA SP	PAK EP TH PAK	DETAIL	MOD	OPMERKINGEN REMARQUES REMARKS BEMERKUNGEN
---	------------------------	-------------------------------------	---	---	----	----	----------------------	------------------------	--------	-----	--

SERIE : -**814****voor-avant-front-Vorne**

A020T563ZA75	80	6	800	920	S17	S17	155	78	6/13	A01.70	Silentbloc
A020T573ZA75	80	8	800	920	S17	S17	196	84	8/10.5	A01.70	Silentbloc
F020T577AA75	70	4	660	890	R42	R42	284	64	1/10+3/14	F01.20	glijdop/pastille
F020T577ZA75	70	4	660	890	R42	R42	272	64	1/10+3/14	F01.20	glijdop/pastille
F020T487AA75	70	4	660	890	R42	R42	286	61	1/10+3/13	F01.20	glijdop/pastille
F020T487ZA75	70	4	660	890	R42	R42	274	61	1/10+3/13	F01.20	glijdop/pastille
F020T521ZA75	80	2	800	920	S17	S17	185	48	2/21 - GA	F01.70	glijdop/pastille
F020T465ZA75	80	2	800	920	S17	S17	199	46	2/20	F01.70	Silentbloc
F020T467ZA75	80	2	800	920	S17	S17	180	48	2/21	F01.70	Silentbloc
F020T519ZA75	80	2	800	920	S17	S17	185	48	2/21	F01.70	Silentbloc
F020T533ZA75	80	2	800	920	S17	S17	180	48	2/21 - GA	F01.70	glijdop/pastille
F020T535ZA75	80	2	800	920	S17	S17	199	46	2/20 - GA	F01.70	glijdop/pastille
F020T531ZA75	80	3	800	920	S17	S17	220	60	3/17 - GA	F01.70	glijdop/pastille
F020T697ZA75	80	3	800	920	S17	S17	240	57	3/16 - GA	F01.70	glijdop/pastille
F020T445ZA75	80	3	800	920	S17	S17	220	60	3/17	F01.70	Silentbloc
F020T403ZA75	80	3	800	920	S17	S17	214	63	3/18	F01.70	Silentbloc
F020T699ZA75	80	3	800	920	S17	S17	240	57	3/16	F01.70	Silentbloc
F020T539ZA75	80	3	800	920	S17	S17	200	63	3/18 - GA	F01.70	glijdop/pastille

BESTELNR N° COMMANDE ORDER NR BESTELNR	BR LRG WID BR	BLADEN LAMES LEAVES BLATT.	B	C	D1	D2	PH FL FA SP	PAK EP TH PAK	DETAIL	MOD	OPMERKINGEN REMARQUES REMARKS BEMERKUNGEN
---	------------------------	-------------------------------------	---	---	----	----	----------------------	------------------------	--------	-----	--

SERIE : -**814****achter-arrière-rear-Hinten**

	A020T778ZA76	80	8/P/5	790	790	S36	S36		147		A01A	
A	A020T778ZA75	80	8	790	790	S36	S36		88	8/11	A01	
H	A020T778HA80	80	5/P	600	600	--	--		59	5/10+P/9	A08	
	A020T594ZA76	80	7/P/5	790	790	S36	S36	148	136		A01A.70	Silentbloc
A	A020T594ZA75	80	7	790	790	S36	S36	148	77	7/11	A01.70	Silentbloc
H	A020T594HA80	80	5/P	600	600	--	--	100	59	5/10+P/9	A08	
	A020T702ZA75	80	8/3	850	850	S36	S36	55	152	8/13+3/16	A01B.70	Silentbloc
	F020T632ZA75	70	3/1	790	790	S36	S30	166	81	3/12+1/36	F01B	glijdop/pastille
	F020T688ZA75	70	4/1	790	790	S30	S30	207	90	4/13.5+1/21	F01B	glijdop/pastille
	F020T688AA75	70	4/1	790	790	S30	S30	207	90	4/13.5+1/21	F01B	glijdop/pastille
	F020T672ZA75	70	4/1	790	790	S30	S30	188	85	4/15,5+1/21	F01B	glijdop/pastille
	F020T672AA75	70	4/1	790	790	S30	S30	188	85	4/15,5+1/21	F01B	glijdop/pastille
	F020T670ZA75	70	4/1	790	790	S36	S30	168	102	4/15,5+1/25	F01B	glijdop/pastille
	F020T786ZA75	70	3/2	790	790	S36	S30	120	122	3/14.5+2/33	F01B	glijdop/pastille
	F020T558ZA75	70	3/2	790	790	S36	S30	146	113	3/13,5+2/30	F01B	glijdop/pastille
	F020T798ZA75	80	2/1	790	790	S36	S36	142	73	2/14+1/36 - GA	F01B	Glijdop/Pastille
	F020T526ZA75	80	2/1	790	790	S36	S36	133	71	2/14+1/34	F01B.70	glijdop/pastille
	F020T498ZA75	80	2/1	790	790	S36	S36	135	75	2/15+1/36	F01B.70	glijdop/pastille
	F020T544ZA75	80	2/1	790	790	S36	S36	136	74	2/14,5+1/36	F01B.70	glijdop/pastille
	F020T604ZA75	80	2/1	790	790	S36	S36	135	75	2/15+1/36 - GA	F01B.70	glijdop/pastille
	F020T606ZA75	80	2/1	790	790	S36	S36	135	75	2/15+1/36 - GA	F01B.70	glijdop/pastille
	F020T608ZA75	80	2/1	790	790	S36	S36	142	73	2/14+1/36	F01B.70	glijdop/pastille
	F020T578ZA75	80	2/1	790	790	S36	S36	130	71	2/14+1/34 - GA	F01B.70	glijdop/pastille
	F020T550ZA75	80	2/2	790	790	S36	S36	112	104	2/14+2/32 - GA	F01B.70	glijdop/pastille
	F020T642ZA75	80	2/2	790	790	S36	S36	112	104	2/14+2/32	F01B.70	glijdop/pastille
	F020T518ZA75	80	2/1	850	860	S36	S36		62	2/13,5+1/26	F01B.70	Silentbloc

BESTELNR N° COMMANDE ORDER NR BESTELNR	BR LRG WID BR	BLADEN LAMES LEAVES BLATT.	B	C	D1	D2	PH FL FA SP	PAK EP TH PAK	DETAIL	MOD	OPMERKINGEN REMARQUES REMARKS BEMERKUNGEN
---	------------------------	-------------------------------------	---	---	----	----	----------------------	------------------------	--------	-----	--

SERIE : -**817****voor-avant-front-Vorne**

A020T563ZA75	80	6	800	920	S17	S17	155	78	6/13	A01.70	Silentbloc
A020T573ZA75	80	8	800	920	S17	S17	196	84	8/10.5	A01.70	Silentbloc
A020T575ZA75	80	8	860	860	S19	S19	178	96	8/12	A01.70	Silentbloc
F020T533ZA75	80	2	800	920	S17	S17	180	48	2/21 - GA	F01.70	glijdop/pastille
F020T521ZA75	80	2	800	920	S17	S17	185	48	2/21 - GA	F01.70	glijdop/pastille
F020T519ZA75	80	2	800	920	S17	S17	185	48	2/21	F01.70	Silentbloc
F020T467ZA75	80	2	800	920	S17	S17	180	48	2/21	F01.70	Silentbloc
F020T403ZA75	80	3	800	920	S17	S17	214	63	3/18	F01.70	Silentbloc
F020T445ZA75	80	3	800	920	S17	S17	220	60	3/17	F01.70	Silentbloc
F020T539ZA75	80	3	800	920	S17	S17	200	63	3/18 - GA	F01.70	glijdop/pastille
F020T531ZA75	80	3	800	920	S17	S17	220	60	3/17 - GA	F01.70	glijdop/pastille

BESTELNR N° COMMANDE ORDER NR BESTELNR	BR LRG WID BR	BLADEN LAMES LEAVES BLATT.	B	C	D1	D2	PH FL FA SP	PAK EP TH PAK	DETAIL	MOD	OPMERKINGEN REMARQUES REMARKS BEMERKUNGEN
---	------------------------	-------------------------------------	---	---	----	----	----------------------	------------------------	--------	-----	--

SERIE : -**817****achter-arrière-rear-Hinten**

	A020T778ZA76	80	8/P/5	790	790	S36	S36		147		A01A	
A	A020T778ZA75	80	8	790	790	S36	S36		88	8/11	A01	
H	A020T778HA80	80	5/P	600	600	--	--		59	5/10+P/9	A08	
	A020T594ZA76	80	7/P/5	790	790	S36	S36	148	136		A01A.70	Silentbloc
A	A020T594ZA75	80	7	790	790	S36	S36	148	77	7/11	A01.70	Silentbloc
H	A020T594HA80	80	5/P	600	600	--	--	100	59	5/10+P/9	A08	
	A020T702ZA75	80	8/3	850	850	S36	S36	55	152	8/13+3/16	A01B.70	Silentbloc
	F020T798ZA75	80	2/1	790	790	S36	S36	142	73	2/14+1/36 - GA	F01B	Glijdop/Pastille
	F020T498ZA75	80	2/1	790	790	S36	S36	135	75	2/15+1/36	F01B.70	glijdop/pastille
	F020T526ZA75	80	2/1	790	790	S36	S36	133	71	2/14+1/34	F01B.70	glijdop/pastille
	F020T544ZA75	80	2/1	790	790	S36	S36	136	74	2/14,5+1/36	F01B.70	glijdop/pastille
	F020T578ZA75	80	2/1	790	790	S36	S36	130	71	2/14+1/34 - GA	F01B.70	glijdop/pastille
	F020T604ZA75	80	2/1	790	790	S36	S36	135	75	2/15+1/36 - GA	F01B.70	glijdop/pastille
	F020T608ZA75	80	2/1	790	790	S36	S36	142	73	2/14+1/36	F01B.70	glijdop/pastille
	F020T606ZA75	80	2/1	790	790	S36	S36	135	75	2/15+1/36 - GA	F01B.70	glijdop/pastille
	F020T518ZA75	80	2/1	850	860	S36	S36		62	2/13,5+1/26	F01B.70	Silentbloc
	F020T592ZA75	80	2	790	790	S36	S36	94	58	1/14+1/35	F74.01	Lenker
	F020T610ZA75	80	2	790	790	S36	S36	92	0		F74.01	Lenker
	F020T612ZA75	80	2	790	790	S36	S36	94	0	1/14+1/35	F74.04	GA/glijdop
	F020T806ZA75	80	2	790	910	S36	S18		57	1/14+1/34	F74.04	GA/glijdop
	F020T614ZA75	80	2	790	775	S36	S36		61	1/17+1/35	F74.05	glijdop/pastille

BESTELNR N° COMMANDE ORDER NR BESTELNR	BR LRG WID BR	BLADEN LAMES LEAVES BLATT.	B	C	D1	D2	PH FL FA SP	PAK EP TH PAK	DETAIL	MOD	OPMERKINGEN REMARQUES REMARKS BEMERKUNGEN
---	------------------------	-------------------------------------	---	---	----	----	----------------------	------------------------	--------	-----	--

SERIE : -

914

voor-avant-front-Vorne

A020T563ZA75	80	6	800	920	S17	S17	155	78	6/13	A01.70	Silentbloc
A020T573ZA75	80	8	800	920	S17	S17	196	84	8/10.5	A01.70	Silentbloc
A020T643ZA75	80	7	860	860	S19	S19	172	84	7/12	A01.70	Silentbloc
A020T575ZA75	80	8	860	860	S19	S19	178	96	8/12	A01.70	Silentbloc
F020T467ZA75	80	2	800	920	S17	S17	180	48	2/21	F01.70	Silentbloc
F020T533ZA75	80	2	800	920	S17	S17	180	48	2/21 - GA	F01.70	glijdop/pastille
F020T403ZA75	80	3	800	920	S17	S17	214	63	3/18	F01.70	Silentbloc
F020T539ZA75	80	3	800	920	S17	S17	200	63	3/18 - GA	F01.70	glijdop/pastille
F020T721ZA75	80	3	800	920	S17	S17	150	66	3/19 - GA	F01.70	glijdop/pastille
F020T543ZA75	80	4	860	860	S19	S19	238	80	4/17 - GA	F01.70	glijdop/pastille

achter-arrière-rear-Hinten

F020T498ZA75	80	2/1	790	790	S36	S36	135	75	2/15+1/36	F01B.70	glijdop/pastille
F020T606ZA75	80	2/1	790	790	S36	S36	135	75	2/15+1/36 - GA	F01B.70	glijdop/pastille
F020T642ZA75	80	2/2	790	790	S36	S36	112	104	2/14+2/32	F01B.70	glijdop/pastille
F020T550ZA75	80	2/2	790	790	S36	S36	112	104	2/14+2/32 - GA	F01B.70	glijdop/pastille

BESTELNR N° COMMANDE ORDER NR BESTELNR	BR LRG WID BR	BLADEN LAMES LEAVES BLATT.	B	C	D1	D2	PH FL FA SP	PAK EP TH PAK	DETAIL	MOD	OPMERKINGEN REMARQUES REMARKS BEMERKUNGEN
---	------------------------	-------------------------------------	---	---	----	----	----------------------	------------------------	--------	-----	--

SERIE : -**917****voor-avant-front-Vorne**

A020T563ZA75	80	6	800	920	S17	S17	155	78	6/13	A01.70	Silentbloc
A020T573ZA75	80	8	800	920	S17	S17	196	84	8/10.5	A01.70	Silentbloc
A020T575ZA75	80	8	860	860	S19	S19	178	96	8/12	A01.70	Silentbloc
A020T657ZA75	80	8	860	860				104	8/13	A01.70	
F020T533ZA75	80	2	800	920	S17	S17	180	48	2/21 - GA	F01.70	glijdop/pastille
F020T539ZA75	80	3	800	920	S17	S17	200	63	3/18 - GA	F01.70	glijdop/pastille
F020T721ZA75	80	3	800	920	S17	S17	150	66	3/19 - GA	F01.70	glijdop/pastille
F020T403ZA75	80	3	800	920	S17	S17	214	63	3/18	F01.70	Silentbloc
F020T537ZA75	80	3	860	860	S17	S17	214	63	3/18 - GA	F01.70	glijdop/pastille
F020T489ZA75	80	3	860	860	S17	S17	214	63	3/18	F01.70	Silentbloc
F020T543ZA75	80	4	860	860	S19	S19	238	80	4/17 - GA	F01.70	glijdop/pastille
F020T461ZA75	80	4	860	860	S19	S19	203	88	4/19	F01.70	Silentbloc
F020T545ZA75	80	4	860	860	S19	S19	203	88	4/19 - GA	F01.70	glijdop/pastille

achter-arrière-rear-Hinten

A	A020T778ZA76	80	8/P/5	790	790	S36	S36		147		A01A	
A	A020T778ZA75	80	8	790	790	S36	S36		88	8/11	A01	
H	A020T778HA80	80	5/P	600	600	--	--		59	5/10+P/9	A08	
A	A020T594ZA76	80	7/P/5	790	790	S36	S36	148	136		A01A.70	Silentbloc
A	A020T594ZA75	80	7	790	790	S36	S36	148	77	7/11	A01.70	Silentbloc
H	A020T594HA80	80	5/P	600	600	--	--	100	59	5/10+P/9	A08	
	F020T798ZA75	80	2/1	790	790	S36	S36	142	73	2/14+1/36 - GA	F01B	Glijdop/Pastille
	F020T498ZA75	80	2/1	790	790	S36	S36	135	75	2/15+1/36	F01B.70	glijdop/pastille
	F020T544ZA75	80	2/1	790	790	S36	S36	136	74	2/14,5+1/36	F01B.70	glijdop/pastille
	F020T526ZA75	80	2/1	790	790	S36	S36	133	71	2/14+1/34	F01B.70	glijdop/pastille
	F020T608ZA75	80	2/1	790	790	S36	S36	142	73	2/14+1/36	F01B.70	glijdop/pastille
	F020T606ZA75	80	2/1	790	790	S36	S36	135	75	2/15+1/36 - GA	F01B.70	glijdop/pastille
	F020T604ZA75	80	2/1	790	790	S36	S36	135	75	2/15+1/36 - GA	F01B.70	glijdop/pastille
	F020T578ZA75	80	2/1	790	790	S36	S36	130	71	2/14+1/34 - GA	F01B.70	glijdop/pastille
	F020T550ZA75	80	2/2	790	790	S36	S36	112	104	2/14+2/32 - GA	F01B.70	glijdop/pastille
	F020T642ZA75	80	2/2	790	790	S36	S36	112	104	2/14+2/32	F01B.70	glijdop/pastille

BESTELNR N° COMMANDE ORDER NR BESTELLNR	BR LRG WID BR	BLADEN LAMES LEAVES BLATT.	B	C	D1	D2	PH FL FA SP	PAK EP TH PAK	DETAIL	MOD	OPMERKINGEN REMARQUES REMARKS BEMERKUNGEN
--	------------------------	-------------------------------------	---	---	----	----	----------------------	------------------------	--------	-----	--

SERIE : -**1114****voor-avant-front-Vorne**

A020T643ZA75	80	7	860	860	S19	S19	172	84	7/12	A01.70	Silentbloc
A020T575ZA75	80	8	860	860	S19	S19	178	96	8/12	A01.70	Silentbloc
A020T657ZA75	80	8	860	860				104	8/13	A01.70	
A020T641ZA75	80	7/P	860	860	S19	S19	94	94	7/12+P/10	A01.70	Silentbloc
F020T541ZA75	80	3	800	920	S17	S17	198	66	3/19 - GA	F01.70	glijdop/pastille
F020T539ZA75	80	3	800	920	S17	S17	200	63	3/18 - GA	F01.70	glijdop/pastille
F020T495ZA75	80	3	800	920	S17	S17	198	66	3/19	F01.70	Silentbloc
F020T403ZA75	80	3	800	920	S17	S17	214	63	3/18	F01.70	Silentbloc
F020T537ZA75	80	3	860	860	S17	S17	214	63	3/18 - GA	F01.70	glijdop/pastille
F020T489ZA75	80	3	860	860	S17	S17	214	63	3/18	F01.70	Silentbloc
F020T543ZA75	80	4	860	860	S19	S19	238	80	4/17 - GA	F01.70	glijdop/pastille
F020T545ZA75	80	4	860	860	S19	S19	203	88	4/19 - GA	F01.70	glijdop/pastille
F020T459ZA75	80	4	860	860	S19	S19	238	80	4/17	F01.70	Silentbloc

BESTELNR N° COMMANDE ORDER NR BESTELNR	BR LRG WID BR	BLADEN LAMES LEAVES BLATT.	B	C	D1	D2	PH FL FA SP	PAK EP TH PAK	DETAIL	MOD	OPMERKINGEN REMARQUES REMARKS BEMERKUNGEN
---	------------------------	-------------------------------------	---	---	----	----	----------------------	------------------------	--------	-----	--

SERIE : -**1114****achter-arrière-rear-Hinten**

	A020T686ZA76	80	9/P/6	850	850	S36	S36	145	205		A01A.70	Silentbloc
A	A020T686ZA75	80	9	850	850	S36	S36	145	117	9/13	A01.70	Silentbloc
H	A020T686HA80	80	6/P	660	660	--	--	58	88	6/13+P/10	A08	
	A020T726ZA76	80	8/P/8	850	850	S36	S36	158	201		A01A.70	Silentbloc
A	A020T726ZA75	80	8	850	850	S36	S36	158	96	8/12	A01.70	Silentbloc
H	A020T726HA80	80	8/P	660	660	--	--	74	106	8/12+P/9	A08	
	F020T496ZA75	80	2/1	850	850	S36	S36	130	93	2/18+1/48	F01B.70	glijdop/pastille
	F020T588ZA75	80	2/1	850	850	S36	S36	121	88	2/17+1/45 - GA	F01B.70	GA/glijdop
	F020T446ZA75	80	2/1	850	850	S36	S36	121	86	2/17+1/43	F01B.70	Silentbloc
	F020T582ZA75	80	2/1	850	850	S36	S36	130	93	2/18+1/48 - GA	F01B.70	GA/glijdop
	F020T576ZA75	80	2/1	850	850	S36	S36	140	88	2/17+1/45	F01B.70	glijdop/pastille
	F020T648ZA75	80	2/1	850	850	S36	S36	140	90	2/17+1/47 - GA	F01B.70	GA/glijdop
	F020T780ZA75	80	3/1	850	850	S36	S36		109	3/17+1/47 - GA	F01B.70	GA/glijdop
	F020T602ZA75	80	3/2	850	860	S36	S36	205	103	1/15+2/12,5+2/24	F01B.70	GA/glijdop
	F020T714ZA75	80	3/2	850	860	S36	S36	200	111	1/18+2/13+2/26 -	F01B.70	GA/glijdop
	F020T600ZA75	80	3/2	850	860	S36	S36	205	103	1/15+2/12,5+2/24	F01B.70	glijdop/pastille
	F020T616ZA75	80	2	850	850	S36	S36	54	0		F74.01	Lenker
	F020T484ZA75	80	2	850	850	S36	S36	72	72	1/19+1/45	F74.01	Lenker
	F020T620ZA75	80	2	850	850	S36	S36	72	0	1/19+1/45	F74.04	GA/glijdop
	F020T622ZA75	80	2	850	850	S36	S36	54	72	1/21+1/45	F74.05	GA

BESTELNR N° COMMANDE ORDER NR BESTELLNR	BR LRG WID BR	BLADEN LAMES LEAVES BLATT.	B	C	D1	D2	PH FL FA SP	PAK EP TH PAK	DETAIL	MOD	OPMERKINGEN REMARQUES REMARKS BEMERKUNGEN
--	------------------------	-------------------------------------	---	---	----	----	----------------------	------------------------	--------	-----	--

SERIE : -**1117****voor-avant-front-Vorne**

A020T643ZA75	80	7	860	860	S19	S19	172	84	7/12	A01.70	Silentbloc
A020T575ZA75	80	8	860	860	S19	S19	178	96	8/12	A01.70	Silentbloc
A020T657ZA75	80	8	860	860				104	8/13	A01.70	
A020T641ZA75	80	7/P	860	860	S19	S19	94	94	7/12+P/10	A01.70	Silentbloc
F020T403ZA75	80	3	800	920	S17	S17	214	63	3/18	F01.70	Silentbloc
F020T541ZA75	80	3	800	920	S17	S17	198	66	3/19 - GA	F01.70	glijdop/pastille
F020T539ZA75	80	3	800	920	S17	S17	200	63	3/18 - GA	F01.70	glijdop/pastille
F020T495ZA75	80	3	800	920	S17	S17	198	66	3/19	F01.70	Silentbloc
F020T537ZA75	80	3	860	860	S17	S17	214	63	3/18 - GA	F01.70	glijdop/pastille
F020T489ZA75	80	3	860	860	S17	S17	214	63	3/18	F01.70	Silentbloc
F020T459ZA75	80	4	860	860	S19	S19	238	80	4/17	F01.70	Silentbloc
F020T545ZA75	80	4	860	860	S19	S19	203	88	4/19 - GA	F01.70	glijdop/pastille
F020T543ZA75	80	4	860	860	S19	S19	238	80	4/17 - GA	F01.70	glijdop/pastille

BESTELNR N° COMMANDE ORDER NR BESTELNR	BR LRG WID BR	BLADEN LAMES LEAVES BLATT.	B	C	D1	D2	PH FL FA SP	PAK EP TH PAK	DETAIL	MOD	OPMERKINGEN REMARQUES REMARKS BEMERKUNGEN
---	------------------------	-------------------------------------	---	---	----	----	----------------------	------------------------	--------	-----	--

SERIE : -**1117****achter-arrière-rear-Hinten**

	A020T686ZA76	80	9/P/6	850	850	S36	S36	145	205		A01A.70	Silentbloc
A	A020T686ZA75	80	9	850	850	S36	S36	145	117	9/13	A01.70	Silentbloc
H	A020T686HA80	80	6/P	660	660	--	--	58	88	6/13+P/10	A08	
	A020T726ZA76	80	8/P/8	850	850	S36	S36	158	201		A01A.70	Silentbloc
A	A020T726ZA75	80	8	850	850	S36	S36	158	96	8/12	A01.70	Silentbloc
H	A020T726HA80	80	8/P	660	660	--	--	74	106	8/12+P/9	A08	
	F020T576ZA75	80	2/1	850	850	S36	S36	140	88	2/17+1/45	F01B.70	glijdop/pastille
	F020T446ZA75	80	2/1	850	850	S36	S36	121	86	2/17+1/43	F01B.70	Silentbloc
	F020T496ZA75	80	2/1	850	850	S36	S36	130	93	2/18+1/48	F01B.70	glijdop/pastille
	F020T582ZA75	80	2/1	850	850	S36	S36	130	93	2/18+1/48 - GA	F01B.70	GA/glijdop
	F020T648ZA75	80	2/1	850	850	S36	S36	140	90	2/17+1/47 - GA	F01B.70	GA/glijdop
	F020T588ZA75	80	2/1	850	850	S36	S36	121	88	2/17+1/45 - GA	F01B.70	GA/glijdop
	F020T780ZA75	80	3/1	850	850	S36	S36		109	3/17+1/47 - GA	F01B.70	GA/glijdop
	F020T602ZA75	80	3/2	850	860	S36	S36	205	103	1/15+2/12,5+2/24	F01B.70	GA/glijdop
	F020T600ZA75	80	3/2	850	860	S36	S36	205	103	1/15+2/12,5+2/24	F01B.70	glijdop/pastille
	F020T714ZA75	80	3/2	850	860	S36	S36	200	111	1/18+2/13+2/26 -	F01B.70	GA/glijdop
	F020T484ZA75	80	2	850	850	S36	S36	72	72	1/19+1/45	F74.01	Lenker
	F020T616ZA75	80	2	850	850	S36	S36	54	0		F74.01	Lenker
	F020T620ZA75	80	2	850	850	S36	S36	72	0	1/19+1/45	F74.04	GA/glijdop
	F020T622ZA75	80	2	850	850	S36	S36	54	72	1/21+1/45	F74.05	GA/

BESTELNR N° COMMANDE ORDER NR BESTELLNR	BR LRG WID BR	BLADEN LAMES LEAVES BLATT.	B	C	D1	D2	PH FL FA SP	PAK EP TH PAK	DETAIL	MOD	OPMERKINGEN REMARQUES REMARKS BEMERKUNGEN
--	------------------------	-------------------------------------	---	---	----	----	----------------------	------------------------	--------	-----	--

SERIE : -**1120****voor-avant-front-Vorne**

A020T643ZA75	80	7	860	860	S19	S19	172	84	7/12	A01.70	Silentbloc
A020T575ZA75	80	8	860	860	S19	S19	178	96	8/12	A01.70	Silentbloc
A020T657ZA75	80	8	860	860				104	8/13	A01.70	
A020T641ZA75	80	7/P	860	860	S19	S19	94	94	7/12+P/10	A01.70	Silentbloc
F020T539ZA75	80	3	800	920	S17	S17	200	63	3/18 - GA	F01.70	glijdop/pastille
F020T541ZA75	80	3	800	920	S17	S17	198	66	3/19 - GA	F01.70	glijdop/pastille
F020T495ZA75	80	3	800	920	S17	S17	198	66	3/19	F01.70	Silentbloc
F020T403ZA75	80	3	800	920	S17	S17	214	63	3/18	F01.70	Silentbloc
F020T537ZA75	80	3	860	860	S17	S17	214	63	3/18 - GA	F01.70	glijdop/pastille
F020T489ZA75	80	3	860	860	S17	S17	214	63	3/18	F01.70	Silentbloc
F020T543ZA75	80	4	860	860	S19	S19	238	80	4/17 - GA	F01.70	glijdop/pastille
F020T545ZA75	80	4	860	860	S19	S19	203	88	4/19 - GA	F01.70	glijdop/pastille
F020T461ZA75	80	4	860	860	S19	S19	203	88	4/19	F01.70	Silentbloc
F020T459ZA75	80	4	860	860	S19	S19	238	80	4/17	F01.70	Silentbloc

BESTELNR N° COMMANDE ORDER NR BESTELNR	BR LRG WID BR	BLADEN LAMES LEAVES BLATT.	B	C	D1	D2	PH FL FA SP	PAK EP TH PAK	DETAIL	MOD	OPMERKINGEN REMARQUES REMARKS BEMERKUNGEN
---	------------------------	-------------------------------------	---	---	----	----	----------------------	------------------------	--------	-----	--

SERIE : -**1120****achter-arrière-rear-Hinten**

A	A020T686ZA76	80	9/P/6	850	850	S36	S36	145	205		A01A.70	Silentbloc
H	A020T686ZA75	80	9	850	850	S36	S36	145	117	9/13	A01.70	Silentbloc
H	A020T686HA80	80	6/P	660	660	--	--	58	88	6/13+P/10	A08	
A	A020T726ZA76	80	8/P/8	850	850	S36	S36	158	201		A01A.70	Silentbloc
H	A020T726ZA75	80	8	850	850	S36	S36	158	96	8/12	A01.70	Silentbloc
H	A020T726HA80	80	8/P	660	660	--	--	74	106	8/12+P/9	A08	
	F020T576ZA75	80	2/1	850	850	S36	S36	140	88	2/17+1/45	F01B.70	glijdop/pastille
	F020T496ZA75	80	2/1	850	850	S36	S36	130	93	2/18+1/48	F01B.70	glijdop/pastille
	F020T588ZA75	80	2/1	850	850	S36	S36	121	88	2/17+1/45 - GA	F01B.70	GA/glijdop
	F020T648ZA75	80	2/1	850	850	S36	S36	140	90	2/17+1/47 - GA	F01B.70	GA/glijdop
	F020T446ZA75	80	2/1	850	850	S36	S36	121	86	2/17+1/43	F01B.70	Silentbloc
	F020T582ZA75	80	2/1	850	850	S36	S36	130	93	2/18+1/48 - GA	F01B.70	GA/glijdop
	F020T780ZA75	80	3/1	850	850	S36	S36		109	3/17+1/47 - GA	F01B.70	GA/glijdop
	F020T600ZA75	80	3/2	850	860	S36	S36	205	103	1/15+2/12,5+2/24	F01B.70	glijdop/pastille
	F020T602ZA75	80	3/2	850	860	S36	S36	205	103	1/15+2/12,5+2/24	F01B.70	GA/glijdop
	F020T484ZA75	80	2	850	850	S36	S36	72	72	1/19+1/45	F74.01	Lenker
	F020T620ZA75	80	2	850	850	S36	S36	72	0	1/19+1/45	F74.04	GA/glijdop
	F020T622ZA75	80	2	850	850	S36	S36	54	72	1/21+1/45	F74.05	GA/

1214**voor-avant-front-Vorne**

	A020T399ZA75	70	10	860	860	25	25	140	130	10/13	A01	
--	--------------	----	----	-----	-----	----	----	-----	-----	-------	-----	--

achter-arrière-rear-Hinten

A	A020T412ZA76	80	9/P/10	808	808	30	30	200	237		A01A	
H	A020T412ZA75	80	9	808	808	30	30	200	117	9/13	A01	
H	A020T412HA80	80	10	625	625	--	--	160	100	10/10	A08	

BESTELNR N° COMMANDE ORDER NR BESTELLNR	BR LRG WID BR	BLADEN LAMES LEAVES BLATT.	B	C	D1	D2	PH FL FA SP	PAK EP TH PAK	DETAIL	MOD	OPMERKINGEN REMARQUES REMARKS BEMERKUNGEN
--	------------------------	-------------------------------------	---	---	----	----	----------------------	------------------------	--------	-----	--

SERIE : -

1217

voor-avant-front-Vorne

A020T399ZA75	70	10	860	860	25	25	140	130	10/13	A01
--------------	----	----	-----	-----	----	----	-----	-----	-------	-----

achter-arrière-rear-Hinten

	A020T412ZA76	80	9/P/10	808	808	30	30	200	237		A01A
A	A020T412ZA75	80	9	808	808	30	30	200	117	9/13	A01
H	A020T412HA80	80	10	625	625	--	--	160	100	10/10	A08

BESTELNR N° COMMANDE ORDER NR BESTELNR	BR LRG WID BR	BLADEN LAMES LEAVES BLATT.	B	C	D1	D2	PH FL FA SP	PAK EP TH PAK	DETAIL	MOD	OPMERKINGEN REMARQUES REMARKS BEMERKUNGEN
---	------------------------	-------------------------------------	---	---	----	----	----------------------	------------------------	--------	-----	--

SERIE : -

1222

voor-avant-front-Vorne

A020T377ZA75	70	7/P	860	860	25	25	100	125		A01	
A020T609ZA75	70	8	860	860	S22	S22	118	104	8/13	A01	Silentbloc
A020T587ZA75	70	8/P	860	860	25	25		128	8/13.5+P/20	A01	
A020T379ZA75	70	8/1	860	860	25	25		127	8/13+P/23	A01	
A020T259ZB75	70	8/P	860	860	25	25	155	132	6/13+2/12+P/30	A01	
A020T267ZC75	70	8/P	860	860	25	25	155	129	8/13+P/25	A01	
A020T399ZA75	70	10	860	860	25	25	140	130	10/13	A01	
A020T375ZA75	70	7/4P	860	860	25	25	135	131	7/13+4P/10	A01	
A020T267ZB75	70	8/P	860	860	25	25	155	129	8/13+P/25	A01.17	
F020T431ZA75	70	3/P	860	860	25	25	145	135	3/23+P/60	F01.70	
F020T433ZA75	70	3	860	860	25	25	132	75	3/23	F01.70	
F020T567ZA75	90	2	750	570	30	30	-15	36	2/14	F01.70	

achter-arrière-rear-Hinten

A	A020T260ZB76	80	8/P/9	800	800	30	30	220	206		A01A
H	A020T260ZB75	80	8	800	800	30	30	220	96	8/12	A01
H	A020T260HB80	80	9	630	630	--	--	150	90	9/10	A08
A	A020T412ZA76	80	9/P/10	808	808	30	30	200	237		A01A
H	A020T412ZA75	80	9	808	808	30	30	200	117	9/13	A01
H	A020T412HA80	80	10	625	625	--	--	160	100	10/10	A08
	A020T260ZC76	80	8/P/9	800	800	30	30	220	206		A01A.17
	A020T416ZA75	80	7/3	802	802	30	30	90	151	7/13+3/20	A01B
	A020T312ZA75	80	5/2	950	950	30	30	73	146	5/18+2/28	A01B.70
A	F020T556ZA76	80	3/P/2	800	800	30	30	164	143		F01A
H	F020T556ZA75	80	3	800	800	30	30	164	81	3/25	F01
H	F020T556HA80	80	2	630	630	--	--	111	42	2/19	F08
A	F020T528ZA76	80	2/P/1	950	950	30	30	160	116		F01A
H	F020T528ZA75	80	2	950	950	30	30	160	68	2/32	F01
H	F020T528HA80	80	1	775	775	--	--	105	28	1/26	F08
A	F020T656ZA76	80	2/P/1	950	950	S22	S22				F01A
H	F020T656ZA75	80	2	950	950					2/32	F01
H	F020T656HA80	80	1	775	775	--	--	0	26	1/26	F08

BESTELNR N° COMMANDE ORDER NR BESTELNR	BR LRG WID BR	BLADEN LAMES LEAVES BLATT.	B	C	D1	D2	PH FL FA SP	PAK EP TH PAK	DETAIL	MOD	OPMERKINGEN REMARKS REMARKS BEMERKUNGEN
---	------------------------	-------------------------------------	---	---	----	----	----------------------	------------------------	--------	-----	--

SERIE : -

1225

voor-avant-front-Vorne

A020T587ZA75	70	8/P	860	860	25	25		128	8/13.5+P/20	A01
A020T399ZA75	70	10	860	860	25	25	140	130	10/13	A01
F020T431ZA75	70	3/P	860	860	25	25	145	135	3/23+P/60	F01.70
F020T567ZA75	90	2	750	570	30	30	-15	36	2/14	F01.70

achter-arrière-rear-Hinten

A020T412ZA76	80	9/P/10	808	808	30	30	200	237		A01A
A020T412ZA75	80	9	808	808	30	30	200	117	9/13	A01
A020T412HA80	80	10	625	625	--	--	160	100	10/10	A08

1226

voor-avant-front-Vorne

A020T609ZA75	70	8	860	860	S22	S22	118	104	8/13	A01	Silentbloc
--------------	----	---	-----	-----	-----	-----	-----	-----	------	-----	------------

1228

voor-avant-front-Vorne

A020T587ZA75	70	8/P	860	860	25	25		128	8/13.5+P/20	A01
A020T267ZC75	70	8/P	860	860	25	25	155	129	8/13+P/25	A01
A020T399ZA75	70	10	860	860	25	25	140	130	10/13	A01
A020T267ZB75	70	8/P	860	860	25	25	155	129	8/13+P/25	A01.17
F020T431ZA75	70	3/P	860	860	25	25	145	135	3/23+P/60	F01.70
F020T433ZA75	70	3	860	860	25	25	132	75	3/23	F01.70

achter-arrière-rear-Hinten

A020T412ZA76	80	9/P/10	808	808	30	30	200	237		A01A
A020T412ZA75	80	9	808	808	30	30	200	117	9/13	A01
A020T412HA80	80	10	625	625	--	--	160	100	10/10	A08
F020T556ZA76	80	3/P/2	800	800	30	30	164	143		F01A
F020T556ZA75	80	3	800	800	30	30	164	81	3/25	F01
F020T556HA80	80	2	630	630	--	--	111	42	2/19	F08

BESTELNR N° COMMANDE ORDER NR BESTELLNR	BR LRG WID BR	BLADEN LAMES LEAVES BLATT.	B	C	D1	D2	PH FL FA SP	PAK EP TH PAK	DETAIL	MOD	OPMERKINGEN REMARQUES REMARKS BEMERKUNGEN
--	------------------------	-------------------------------------	---	---	----	----	----------------------	------------------------	--------	-----	--

SERIE : -

1314

voor-avant-front-Vorne

A020T657ZA75	80	8	860	860				104	8/13	A01.70	
A020T575ZA75	80	8	860	860	S19	S19	178	96	8/12	A01.70	Silentbloc
F020T545ZA75	80	4	860	860	S19	S19	203	88	4/19 - GA	F01.70	glijdop/pastille
F020T543ZA75	80	4	860	860	S19	S19	238	80	4/17 - GA	F01.70	glijdop/pastille
F020T461ZA75	80	4	860	860	S19	S19	203	88	4/19	F01.70	Silentbloc
F020T459ZA75	80	4	860	860	S19	S19	238	80	4/17	F01.70	Silentbloc

achter-arrière-rear-Hinten

A	A020T686ZA76	80	9/P/6	850	850	S36	S36	145	205		A01A.70	Silentbloc
A	A020T686ZA75	80	9	850	850	S36	S36	145	117	9/13	A01.70	Silentbloc
H	A020T686HA80	80	6/P	660	660	--	--	58	88	6/13+P/10	A08	
A	A020T754ZA76	80	9/P/7	850	850				0		A01A.70	
A	A020T754ZA75	80	9	850	850				126	9/14	A01.70	
H	A020T754HA80	80	7/P	660	660	--	--		107	7/14+P/9	A08	
	F020T638ZA75	80	2/2	850	850	S36	S36	90	139	1/22+1/27+2/39 -	F01B	glijdop/pastille
	F020T648ZA75	80	2/1	850	850	S36	S36	140	90	2/17+1/47 - GA	F01B.70	GA/glijdop
	F020T582ZA75	80	2/1	850	850	S36	S36	130	93	2/18+1/48 - GA	F01B.70	GA/glijdop
	F020T576ZA75	80	2/1	850	850	S36	S36	140	88	2/17+1/45	F01B.70	glijdop/pastille
	F020T496ZA75	80	2/1	850	850	S36	S36	130	93	2/18+1/48	F01B.70	glijdop/pastille
	F020T780ZA75	80	3/1	850	850	S36	S36		109	3/17+1/47 - GA	F01B.70	GA/glijdop
	F020T580ZA75	80	2/2	850	850	S36	S36	135	116	2/16+2/36 - GA	F01B.70	GA/glijdop
	F020T524ZA75	80	2/2	850	850	S36	S36	128	116	2/16+2/36	F01B.70	glijdop/pastille
	F020T484ZA75	80	2	850	850	S36	S36	72	72	1/19+1/45	F74.01	Lenker
	F020T620ZA75	80	2	850	850	S36	S36	72	0	1/19+1/45	F74.04	GA/glijdop

BESTELNR N° COMMANDE ORDER NR BESTELNR	BR LRG WID BR	BLADEN LAMES LEAVES BLATT.	B	C	D1	D2	PH FL FA SP	PAK EP TH PAK	DETAIL	MOD	OPMERKINGEN REMARQUES REMARKS BEMERKUNGEN
---	------------------------	-------------------------------------	---	---	----	----	----------------------	------------------------	--------	-----	--

SERIE : -

1317

voor-avant-front-Vorne

A020T575ZA75	80	8	860	860	S19	S19	178	96	8/12	A01.70	Silentbloc
A020T657ZA75	80	8	860	860				104	8/13	A01.70	
F020T459ZA75	80	4	860	860	S19	S19	238	80	4/17	F01.70	Silentbloc
F020T545ZA75	80	4	860	860	S19	S19	203	88	4/19 - GA	F01.70	glijdop/pastille
F020T543ZA75	80	4	860	860	S19	S19	238	80	4/17 - GA	F01.70	glijdop/pastille
F020T461ZA75	80	4	860	860	S19	S19	203	88	4/19	F01.70	Silentbloc

achter-arrière-rear-Hinten

A	A020T686ZA76	80	9/P/6	850	850	S36	S36	145	205		A01A.70	Silentbloc
A	A020T686ZA75	80	9	850	850	S36	S36	145	117	9/13	A01.70	Silentbloc
H	A020T686HA80	80	6/P	660	660	--	--	58	88	6/13+P/10	A08	
A	A020T754ZA76	80	9/P/7	850	850				0		A01A.70	
A	A020T754ZA75	80	9	850	850				126	9/14	A01.70	
H	A020T754HA80	80	7/P	660	660	--	--		107	7/14+P/9	A08	
	F020T638ZA75	80	2/2	850	850	S36	S36	90	139	1/22+1/27+2/39 -	F01B	glijdop/pastille
	F020T648ZA75	80	2/1	850	850	S36	S36	140	90	2/17+1/47 - GA	F01B.70	GA/glijdop
	F020T582ZA75	80	2/1	850	850	S36	S36	130	93	2/18+1/48 - GA	F01B.70	GA/glijdop
	F020T576ZA75	80	2/1	850	850	S36	S36	140	88	2/17+1/45	F01B.70	glijdop/pastille
	F020T496ZA75	80	2/1	850	850	S36	S36	130	93	2/18+1/48	F01B.70	glijdop/pastille
	F020T580ZA75	80	2/2	850	850	S36	S36	135	116	2/16+2/36 - GA	F01B.70	GA/glijdop
	F020T524ZA75	80	2/2	850	850	S36	S36	128	116	2/16+2/36	F01B.70	glijdop/pastille
	F020T712ZA75	80	3/2	850	860	S36	S36	200	111	1/18+2/13+2/26	F01B.70	glijdop/pastille
	F020T714ZA75	80	3/2	850	860	S36	S36	200	111	1/18+2/13+2/26 -	F01B.70	GA/glijdop
	F020T484ZA75	80	2	850	850	S36	S36	72	72	1/19+1/45	F74.01	Lenker
	F020T620ZA75	80	2	850	850	S36	S36	72	0	1/19+1/45	F74.04	GA/glijdop

BESTELNR N° COMMANDE ORDER NR BESTELNR	BR LRG WID BR	BLADEN LAMES LEAVES BLATT.	B	C	D1	D2	PH FL FA SP	PAK EP TH PAK	DETAIL	MOD	OPMERKINGEN REMARQUES REMARKS BEMERKUNGEN
---	------------------------	-------------------------------------	---	---	----	----	----------------------	------------------------	--------	-----	--

SERIE : -

1320

voor-avant-front-Vorne

A020T575ZA75	80	8	860	860	S19	S19	178	96	8/12	A01.70	Silentbloc
A020T657ZA75	80	8	860	860				104	8/13	A01.70	
F020T461ZA75	80	4	860	860	S19	S19	203	88	4/19	F01.70	Silentbloc
F020T543ZA75	80	4	860	860	S19	S19	238	80	4/17 - GA	F01.70	glijdop/pastille
F020T459ZA75	80	4	860	860	S19	S19	238	80	4/17	F01.70	Silentbloc
F020T545ZA75	80	4	860	860	S19	S19	203	88	4/19 - GA	F01.70	glijdop/pastille

achter-arrière-rear-Hinten

A	A020T686ZA76	80	9/P/6	850	850	S36	S36	145	205		A01A.70	Silentbloc
	A020T686ZA75	80	9	850	850	S36	S36	145	117	9/13	A01.70	Silentbloc
H	A020T686HA80	80	6/P	660	660	--	--	58	88	6/13+P/10	A08	
	A020T754ZA76	80	9/P/7	850	850				0		A01A.70	
A	A020T754ZA75	80	9	850	850				126	9/14	A01.70	
H	A020T754HA80	80	7/P	660	660	--	--		107	7/14+P/9	A08	
	F020T582ZA75	80	2/1	850	850	S36	S36	130	93	2/18+1/48 - GA	F01B.70	GA/glijdop
	F020T446ZA75	80	2/1	850	850	S36	S36	121	86	2/17+1/43	F01B.70	Silentbloc
	F020T496ZA75	80	2/1	850	850	S36	S36	130	93	2/18+1/48	F01B.70	glijdop/pastille
	F020T588ZA75	80	2/1	850	850	S36	S36	121	88	2/17+1/45 - GA	F01B.70	GA/glijdop
	F020T524ZA75	80	2/2	850	850	S36	S36	128	116	2/16+2/36	F01B.70	glijdop/pastille
	F020T580ZA75	80	2/2	850	850	S36	S36	135	116	2/16+2/36 - GA	F01B.70	GA/glijdop
	F020T714ZA75	80	3/2	850	860	S36	S36	200	111	1/18+2/13+2/26 -	F01B.70	GA/glijdop
	F020T712ZA75	80	3/2	850	860	S36	S36	200	111	1/18+2/13+2/26	F01B.70	glijdop/pastille
	F020T484ZA75	80	2	850	850	S36	S36	72	72	1/19+1/45	F74.01	Lenker
	F020T620ZA75	80	2	850	850	S36	S36	72	0	1/19+1/45	F74.04	GA/glijdop

BESTELNR N° COMMANDE ORDER NR BESTELNR	BR LRG WID BR	BLADEN LAMES LEAVES BLATT.	B	C	D1	D2	PH FL FA SP	PAK EP TH PAK	DETAIL	MOD	OPMERKINGEN REMARQUES REMARKS BEMERKUNGEN
---	------------------------	-------------------------------------	---	---	----	----	----------------------	------------------------	--------	-----	--

SERIE : -

1324

voor-avant-front-Vorne

A020T657ZA75	80	8	860	860				104	8/13	A01.70	
A020T575ZA75	80	8	860	860	S19	S19	178	96	8/12	A01.70	Silentbloc
F020T521ZA75	80	2	800	920	S17	S17	185	48	2/21 - GA	F01.70	glijdop/pastille
F020T519ZA75	80	2	800	920	S17	S17	185	48	2/21	F01.70	Silentbloc
F020T543ZA75	80	4	860	860	S19	S19	238	80	4/17 - GA	F01.70	glijdop/pastille
F020T545ZA75	80	4	860	860	S19	S19	203	88	4/19 - GA	F01.70	glijdop/pastille
F020T461ZA75	80	4	860	860	S19	S19	203	88	4/19	F01.70	Silentbloc

achter-arrière-rear-Hinten

A	A020T686ZA76	80	9/P/6	850	850	S36	S36	145	205		A01A.70	Silentbloc
H	A020T686ZA75	80	9	850	850	S36	S36	145	117	9/13	A01.70	Silentbloc
H	A020T686HA80	80	6/P	660	660	--	--	58	88	6/13+P/10	A08	
A	A020T754ZA76	80	9/P/7	850	850				0		A01A.70	
H	A020T754ZA75	80	9	850	850				126	9/14	A01.70	
H	A020T754HA80	80	7/P	660	660	--	--		107	7/14+P/9	A08	
	F020T588ZA75	80	2/1	850	850	S36	S36	121	88	2/17+1/45 - GA	F01B.70	GA/glijdop
	F020T582ZA75	80	2/1	850	850	S36	S36	130	93	2/18+1/48 - GA	F01B.70	GA/glijdop
	F020T580ZA75	80	2/2	850	850	S36	S36	135	116	2/16+2/36 - GA	F01B.70	GA/glijdop
	F020T524ZA75	80	2/2	850	850	S36	S36	128	116	2/16+2/36	F01B.70	glijdop/pastille
	F020T714ZA75	80	3/2	850	860	S36	S36	200	111	1/18+2/13+2/26 -	F01B.70	GA/glijdop
	F020T620ZA75	80	2	850	850	S36	S36	72	0	1/19+1/45	F74.04	GA/glijdop

BESTELNR N° COMMANDE ORDER NR BESTELLNR	BR LRG WID BR	BLADEN LAMES LEAVES BLATT.	B	C	D1	D2	PH FL FA SP	PAK EP TH PAK	DETAIL	MOD	OPMERKINGEN REMARQUES REMARKS BEMERKUNGEN
--	------------------------	-------------------------------------	---	---	----	----	----------------------	------------------------	--------	-----	--

SERIE : -**1414****voor-avant-front-Vorne**

A020T267ZC75	70	8/P	860	860	25	25	155	129	8/13+P/25	A01
A020T399ZA75	70	10	860	860	25	25	140	130	10/13	A01
A020T267ZB75	70	8/P	860	860	25	25	155	129	8/13+P/25	A01.17
A020T455ZA75	80	9/2/P	860	860	25	25	157	142	9/11,5+2/15+P/8	A01B
A020T457ZA75	80	11/2	860	860	25	25	184	151	1/14+10/10,5+2/1	A01B
F020T431ZA75	70	3/P	860	860	25	25	145	135	3/23+P/60	F01.70
F020T433ZA75	70	3	860	860	25	25	132	75	3/23	F01.70
F020T363ZA75	80	3	860	860	25	25	145	75	3/23	F01.70

BESTELNR N° COMMANDE ORDER NR BESTELNR	BR LRG WID BR	BLADEN LAMES LEAVES BLATT.	B	C	D1	D2	PH FL FA SP	PAK EP TH PAK	DETAIL	MOD	OPMERKINGEN REMARKS REMARKS BEMERKUNGEN
---	------------------------	-------------------------------------	---	---	----	----	----------------------	------------------------	--------	-----	--

SERIE : -**1414****achter-arrière-rear-Hinten**

	A020T258ZB76										
A	A020T540ZA76	80	13/P/10	950	725	30	30	100	309		A01A
	A020T540ZA75	80	13	950	725	30	30	100	169	13/13	A01
H	A020T540HA80	80	10	770	545	--	--	11	120	10/12	A08
A	A020T258ZA76	80	6/P/5	950	950	30	30	240	196		A01A
	A020T258ZA75	80	6	950	950	30	30	240	96	6/16	A01
H	A020T258HA80	80	5/P	750	750	--	--	165	100	5/16+P/20	A08
A	A020T316ZB76	80	6/P/5	950	950	30	30	205	197		A01A
	A020T316ZB75	80	6	950	950	30	30	205	102	6/17	A01
H	A020T316HB80	80	5	750	750	--	--	140	85	5/17	A08
A	A020T320ZB76	80	7/P/7	956	956	30	30	220	244		A01A
	A020T320ZB75	80	7	956	956	30	30	220	112	7/16	A01
H	A020T320HB80	80	7	770	770	--	--	120	112	7/16	A08
A	A020T316ZA76	80	6/P/5	950	950	30	30		207	6/17+5/17+P/20	A01A.17
	A020T316ZA75	80	6	950	950	30	30		102	6/17	A01.17
H	A020T316HA80										
A	A020T320ZA76	80	7/P/7	956	956	30	30	220	244		A01A.17
	A020T320ZA75	80	7	956	956	30	30	220	112	7/16	A01.17
H	A020T320HA80	80	7	770	770	--	--	220	112	7/16	A08
	A020T358ZA75	80	5/3	950	950	30	30	32	174	5/18+3/28	A01B
	A020T284ZA75	80	5/2	950	950	30	30	65	150	5/18+2/30	A01B.70
A	F020T530ZA76	80	3/P/2	950	950	30	30	207	159	3/25+P/20+2/27	F01A
	F020T530ZA75	80	3	950	950	30	30	205	81	3/25	F01
H	F020T530HA80	80	2	775	775	--	--	58	58	2/27	F08
A	F020T302ZA76	80	3/P/2	950	950	30	30	195	160		F01A
	F020T302ZA75	80	3	950	950	30	30	195	84	3/26	F01
H	F020T302HA80	80	2	775	775	--	--	100	56	2/26	F08
A	F020T458ZA76	80	3/P/3	950	950	30	30	205	185		F01A
	F020T458ZA75	80	3	950	950	30	30	205	84	3/26	F01
H	F020T458HA80	80	3	775	775	--	--	89	81	3/25	F08

BESTELNR N° COMMANDE ORDER NR BESTELNR	BR LRG WID BR	BLADEN LAMES LEAVES BLATT.	B	C	D1	D2	PH FL FA SP	PAK EP TH PAK	DETAIL	MOD	OPMERKINGEN REMARQUES REMARKS BEMERKUNGEN
---	------------------------	-------------------------------------	---	---	----	----	----------------------	------------------------	--------	-----	--

SERIE : -**1417****voor-avant-front-Vorne**

A020T609ZA75	70	8	860	860	S22	S22	118	104	8/13	A01	Silentbloc
A020T267ZC75	70	8/P	860	860	25	25	155	129	8/13+P/25	A01	
A020T587ZA75	70	8/P	860	860	25	25		128	8/13.5+P/20	A01	
A020T581ZA75	70	10	860	860	S22	S22	130	135	10/13.5	A01	Silentbloc
A020T341ZB75	70	10	860	860	25	25	120	135	5/14+5/13	A01	
A020T399ZA75	70	10	860	860	25	25	140	130	10/13	A01	
A020T677ZA75	80	14	860	860	S22	S22	176	147	14/10.5	A01	Silentbloc
A020T267ZB75	70	8/P	860	860	25	25	155	129	8/13+P/25	A01.17	
A020T341ZA75	70	10	860	860	25	25	120	135	5/14+5/13	A01.17	Vervangen
A020T455ZA75	80	9/2/P	860	860	25	25	157	142	9/11,5+2/15+P/8	A01B	
A020T651ZA75	80	11/2	860	860	S22	S22	164	150	11/10.5+2/17	A01B	Silentbloc
A020T457ZA75	80	11/2	860	860	25	25	184	151	1/14+10/10,5+2/1	A01B	
F020T499ZA75	80	3	860	860	S22	S22	125	81	3/24	F01	
F020T501ZA75	80	4	860	860	S22	S22	115	100	4/22	F01	
F020T433ZA75	70	3	860	860	25	25	132	75	3/23	F01.70	
F020T431ZA75	70	3/P	860	860	25	25	145	135	3/23+P/60	F01.70	
F020T363ZA75	80	3	860	860	25	25	145	75	3/23	F01.70	

BESTELNR N° COMMANDE ORDER NR BESTELLNR	BR LRG WID BR	BLADEN LAMES LEAVES BLATT.	B	C	D1	D2	PH FL FA SP	PAK EP TH PAK	DETAIL	MOD	OPMERKINGEN REMARKS BEMERKUNGEN
--	------------------------	-------------------------------------	---	---	----	----	----------------------	------------------------	--------	-----	---------------------------------------

SERIE : -

1417

achter-arrière-rear-Hinten

	A020T258ZB76										
A	A020T400ZA76	80	9/P/9	725	950	30	30	145	268		A01A
	A020T400ZA75	80	9	725	950	30	30	145	131	9/14,5	A01
H	A020T400HA80	80	9	525	750	--	--	40	113	9/12,5	A08
A	A020T540ZA76	80	13/P/10	950	725	30	30	100	309		A01A
	A020T540ZA75	80	13	950	725	30	30	100	169	13/13	A01
H	A020T540HA80	80	10	770	545	--	--	11	120	10/12	A08
A	A020T258ZA76	80	6/P/5	950	950	30	30	240	196		A01A
	A020T258ZA75	80	6	950	950	30	30	240	96	6/16	A01
H	A020T258HA80	80	5/P	750	750	--	--	165	100	5/16+P/20	A08
A	A020T316ZB76	80	6/P/5	950	950	30	30	205	197		A01A
	A020T316ZB75	80	6	950	950	30	30	205	102	6/17	A01
H	A020T316HB80	80	5	750	750	--	--	140	85	5/17	A08
A	A020T652ZA76	80	7/P/7	950	950	S22	S22	177	244		A01A Silentbloc
	A020T652ZA75	80	7	950	950	S22	S22	177	112	7/16	A01 Silentbloc
H	A020T652HA80	80	7	775	775	--	--	43	112	7/16	A08
A	A020T244ZC76	80	9/7	950	950	30	30	145	272		A01A
	A020T244ZC75	80	9	950	950	30	30	145	153	9/17	A01
H	A020T244HC80	80	7	750	750	--	--	63	119	7/17	A08
A	A020T654ZA76	80	9/7	950	950	S22	S22	126	272		A01A Silentbloc
	A020T654ZA75	80	9	950	950	S22	S22	125	153	9/17	A01 Silentbloc
H	A020T654HA80	80	7	750	750	--	--	0	119	7/17	A08
A	A020T320ZB76	80	7/P/7	956	956	30	30	220	244		A01A
	A020T320ZB75	80	7	956	956	30	30	220	112	7/16	A01
H	A020T320HB80	80	7	770	770	--	--	120	112	7/16	A08
A	A020T316ZA76	80	6/P/5	950	950	30	30		207	6/17+5/17+P/20	A01A.17
	A020T316ZA75	80	6	950	950	30	30		102	6/17	A01.17
H	A020T316HA80										
A	A020T320ZA76	80	7/P/7	956	956	30	30	220	244		A01A.17
	A020T320ZA75	80	7	956	956	30	30	220	112	7/16	A01.17
H	A020T320HA80	80	7	770	770	--	--	220	112	7/16	A08
	A020T358ZA75	80	5/3	950	950	30	30	32	174	5/18+3/28	A01B
	A020T284ZA75	80	5/2	950	950	30	30	65	150	5/18+2/30	A01B.70
A	F020T586ZA76	80	4/4	950	725	S22	S22	140	214		F01A Silentbloc
	F020T586ZA75	80	4	950	725	S22	S22	140	118	4/24	F01 Silentbloc
H	F020T586HA80	80	4	770	550	--	--	45	96	4/21	F08
A	F020T530ZA76	80	3/P/2	950	950	30	30	207	159	3/25+P/20+2/27	F01A
	F020T530ZA75	80	3	950	950	30	30	205	81	3/25	F01
H	F020T530HA80	80	2	775	775	--	--	58	58	2/27	F08
A	F020T658ZA76	80	3/P/2	950	950	S22	S22	187	157		F01A
	F020T658ZA75	80	3	950	950	S22	S22	187	79	3/25	F01 Silentbloc
H	F020T658HA80	80	2	775	775	--	--	55	58	2/27	F08

BESTELNR N° COMMANDE ORDER NR BESTELLNR	BR LRG WID BR	BLADEN LAMES LEAVES BLATT.	B	C	D1	D2	PH FL FA SP	PAK EP TH PAK	DETAIL	MOD	OPMERKINGEN REMARQUES REMARKS BEMERKUNGEN
--	------------------------	-------------------------------------	---	---	----	----	----------------------	------------------------	--------	-----	--

SERIE : -

1417

	F020T302ZA76	80	3/P/2	950	950	30	30	195	160		F01A	
A	F020T302ZA75	80	3	950	950	30	30	195	84	3/26	F01	
H	F020T302HA80	80	2	775	775	--	--	100	56	2/26	F08	
	F020T570ZA76	80	3/3	950	950	S22	S22	180	171		F01A	Silentbloc
A	F020T570ZA75	80	3	950	950	S22	S22	180	87	3/26	F01	Silentbloc
H	F020T570HA80	80	3	760	760	--	--	70	84	3/25	F08	
	F020T458ZA76	80	3/P/3	950	950	30	30	205	185		F01A	
A	F020T458ZA75	80	3	950	950	30	30	205	84	3/26	F01	
H	F020T458HA80	80	3	775	775	--	--	89	81	3/25	F08	

BESTELNR N° COMMANDE ORDER NR BESTELNR	BR LRG WID BR	BLADEN LAMES LEAVES BLATT.	B	C	D1	D2	PH FL FA SP	PAK EP TH PAK	DETAIL	MOD	OPMERKINGEN REMARQUES REMARKS BEMERKUNGEN
---	------------------------	-------------------------------------	---	---	----	----	----------------------	------------------------	--------	-----	--

SERIE : -

1419

voor-avant-front-Vorne

A020T339ZA75	70	8/P	860	860	25	25	196	130	8/13+P/26	A01
A020T267ZC75	70	8/P	860	860	25	25	155	129	8/13+P/25	A01
A020T399ZA75	70	10	860	860	25	25	140	130	10/13	A01
A020T267ZB75	70	8/P	860	860	25	25	155	129	8/13+P/25	A01.17
A020T457ZA75	80	11/2	860	860	25	25	184	151	1/14+10/10,5+2/1	A01B
A020T547ZA75	80	11/2/P	860	860	25	25	184	157	11/10,5+2/16+P/8	A01B
F020T423ZA75	70	3	860	860	25	25	184	75	3/23	F01.70
F020T431ZA75	70	3/P	860	860	25	25	145	135	3/23+P/60	F01.70
F020T433ZA75	70	3	860	860	25	25	132	75	3/23	F01.70
F020T415ZA75	80	3	860	860	25	25	172	75	3/23	F01.70
F020T477ZA75	80	4	860	860	25	25	151	96	4/22	F01.70

BESTELNR N° COMMANDE ORDER NR BESTELNR	BR LRG WID BR	BLADEN LAMES LEAVES BLATT.	B	C	D1	D2	PH FL FA SP	PAK EP TH PAK	DETAIL	MOD	OPMERKINGEN REMARQUES REMARKS BEMERKUNGEN
---	------------------------	-------------------------------------	---	---	----	----	----------------------	------------------------	--------	-----	--

SERIE : -**1419****achter-arrière-rear-Hinten**

	A020T258ZB76										
A	A020T316ZB76	80	6/P/5	950	950	30	30	205	197		A01A
	A020T316ZB75	80	6	950	950	30	30	205	102	6/17	A01
H	A020T316HB80	80	5	750	750	--	--	140	85	5/17	A08
A	A020T258ZA76	80	6/P/5	950	950	30	30	240	196		A01A
	A020T258ZA75	80	6	950	950	30	30	240	96	6/16	A01
H	A020T258HA80	80	5/P	750	750	--	--	165	100	5/16+P/20	A08
A	A020T320ZB76	80	7/P/7	956	956	30	30	220	244		A01A
	A020T320ZB75	80	7	956	956	30	30	220	112	7/16	A01
H	A020T320HB80	80	7	770	770	--	--	120	112	7/16	A08
A	A020T316ZA76	80	6/P/5	950	950	30	30		207	6/17+5/17+P/20	A01A.17
	A020T316ZA75	80	6	950	950	30	30		102	6/17	A01.17
H	A020T316HA80										
A	A020T320ZA76	80	7/P/7	956	956	30	30	220	244		A01A.17
	A020T320ZA75	80	7	956	956	30	30	220	112	7/16	A01.17
H	A020T320HA80	80	7	770	770	--	--	220	112	7/16	A08
	A020T358ZA75	80	5/3	950	950	30	30	32	174	5/18+3/28	A01B
	A020T284ZA75	80	5/2	950	950	30	30	65	150	5/18+2/30	A01B.70
A	F020T302ZA76	80	3/P/2	950	950	30	30	195	160		F01A
	F020T302ZA75	80	3	950	950	30	30	195	84	3/26	F01
H	F020T302HA80	80	2	775	775	--	--	100	56	2/26	F08
A	F020T530ZA76	80	3/P/2	950	950	30	30	207	159	3/25+P/20+2/27	F01A
	F020T530ZA75	80	3	950	950	30	30	205	81	3/25	F01
H	F020T530HA80	80	2	775	775	--	--	58	58	2/27	F08
A	F020T458ZA76	80	3/P/3	950	950	30	30	205	185		F01A
	F020T458ZA75	80	3	950	950	30	30	205	84	3/26	F01
H	F020T458HA80	80	3	775	775	--	--	89	81	3/25	F08

BESTELNR N° COMMANDE ORDER NR BESTELNR	BR LRG WID BR	BLADEN LAMES LEAVES BLATT.	B	C	D1	D2	PH FL FA SP	PAK EP TH PAK	DETAIL	MOD	OPMERKINGEN REMARQUES REMARKS BEMERKUNGEN
---	------------------------	-------------------------------------	---	---	----	----	----------------------	------------------------	--------	-----	--

SERIE : -**1420****voor-avant-front-Vorne**

A020T609ZA75	70	8	860	860	S22	S22	118	104	8/13	A01	Silentbloc
A020T339ZA75	70	8/P	860	860	25	25	196	130	8/13+P/26	A01	
A020T267ZC75	70	8/P	860	860	25	25	155	129	8/13+P/25	A01	
A020T399ZA75	70	10	860	860	25	25	140	130	10/13	A01	
A020T677ZA75	80	14	860	860	S22	S22	176	147	14/10.5	A01	Silentbloc
A020T267ZB75	70	8/P	860	860	25	25	155	129	8/13+P/25	A01.17	
A020T455ZA75	80	9/2/P	860	860	25	25	157	142	9/11,5+2/15+P/8	A01B	
A020T457ZA75	80	11/2	860	860	25	25	184	151	1/14+10/10,5+2/1	A01B	
A020T547ZA75	80	11/2/P	860	860	25	25	184	157	11/10,5+2/16+P/8	A01B	
F020T499ZA75	80	3	860	860	S22	S22	125	81	3/24	F01	
F020T433ZA75	70	3	860	860	25	25	132	75	3/23	F01.70	
F020T423ZA75	70	3	860	860	25	25	184	75	3/23	F01.70	
F020T431ZA75	70	3/P	860	860	25	25	145	135	3/23+P/60	F01.70	
F020T493ZA75	70	4/P	860	860	25	25	218	132	4/19+P/48	F01.70	
F020T363ZA75	80	3	860	860	25	25	145	75	3/23	F01.70	
F020T415ZA75	80	3	860	860	25	25	172	75	3/23	F01.70	
F020T491ZA75	80	4	860	860	25	25	211	85	1/20+3/19	F01.70	

BESTELNR N° COMMANDE ORDER NR BESTELNR	BR LRG WID BR	BLADEN LAMES LEAVES BLATT.	B	C	D1	D2	PH FL FA SP	PAK EP TH PAK	DETAIL	MOD	OPMERKINGEN REMARQUES REMARKS BEMERKUNGEN
---	------------------------	-------------------------------------	---	---	----	----	----------------------	------------------------	--------	-----	--

SERIE : -

1420

achter-arrière-rear-Hinten

	A020T258ZB76											
A	A020T258ZA76	80	6/P/5	950	950	30	30	240	196		A01A	
	A020T258ZA75	80	6	950	950	30	30	240	96	6/16	A01	
H	A020T258HA80	80	5/P	750	750	--	--	165	100	5/16+P/20	A08	
A	A020T316ZB76	80	6/P/5	950	950	30	30	205	197		A01A	
	A020T316ZB75	80	6	950	950	30	30	205	102	6/17	A01	
H	A020T316HB80	80	5	750	750	--	--	140	85	5/17	A08	
A	A020T652ZA76	80	7/P/7	950	950	S22	S22	177	244		A01A	Silentbloc
	A020T652ZA75	80	7	950	950	S22	S22	177	112	7/16	A01	Silentbloc
H	A020T652HA80	80	7	775	775	--	--	43	112	7/16	A08	
A	A020T654ZA76	80	9/7	950	950	S22	S22	126	272		A01A	Silentbloc
	A020T654ZA75	80	9	950	950	S22	S22	125	153	9/17	A01	Silentbloc
H	A020T654HA80	80	7	750	750	--	--	0	119	7/17	A08	
A	A020T320ZB76	80	7/P/7	956	956	30	30	220	244		A01A	
	A020T320ZB75	80	7	956	956	30	30	220	112	7/16	A01	
H	A020T320HB80	80	7	770	770	--	--	120	112	7/16	A08	
A	A020T316ZA76	80	6/P/5	950	950	30	30		207	6/17+5/17+P/20	A01A.17	
	A020T316ZA75	80	6	950	950	30	30		102	6/17	A01.17	
H	A020T316HA80											
A	A020T320ZA76	80	7/P/7	956	956	30	30	220	244		A01A.17	
	A020T320ZA75	80	7	956	956	30	30	220	112	7/16	A01.17	
H	A020T320HA80	80	7	770	770	--	--	220	112	7/16	A08	
	A020T358ZA75	80	5/3	950	950	30	30	32	174	5/18+3/28	A01B	
	A020T284ZA75	80	5/2	950	950	30	30	65	150	5/18+2/30	A01B.70	
A	F020T658ZA76	80	3/P/2	950	950	S22	S22	187	157		F01A	
	F020T658ZA75	80	3	950	950	S22	S22	187	79	3/25	F01	Silentbloc
H	F020T658HA80	80	2	775	775	--	--	55	58	2/27	F08	
A	F020T302ZA76	80	3/P/2	950	950	30	30	195	160		F01A	
	F020T302ZA75	80	3	950	950	30	30	195	84	3/26	F01	
H	F020T302HA80	80	2	775	775	--	--	100	56	2/26	F08	
A	F020T530ZA76	80	3/P/2	950	950	30	30	207	159	3/25+P/20+2/27	F01A	
	F020T530ZA75	80	3	950	950	30	30	205	81	3/25	F01	
H	F020T530HA80	80	2	775	775	--	--	58	58	2/27	F08	
A	F020T458ZA76	80	3/P/3	950	950	30	30	205	185		F01A	
	F020T458ZA75	80	3	950	950	30	30	205	84	3/26	F01	
H	F020T458HA80	80	3	775	775	--	--	89	81	3/25	F08	
A	F020T570ZA76	80	3/3	950	950	S22	S22	180	171		F01A	Silentbloc
	F020T570ZA75	80	3	950	950	S22	S22	180	87	3/26	F01	Silentbloc
H	F020T570HA80	80	3	760	760	--	--	70	84	3/25	F08	

BESTELNR N° COMMANDE ORDER NR BESTELNR	BR LRG WID BR	BLADEN LAMES LEAVES BLATT.	B	C	D1	D2	PH FL FA SP	PAK EP TH PAK	DETAIL	MOD	OPMERKINGEN REMARKS BEMERKUNGEN
---	------------------------	-------------------------------------	---	---	----	----	----------------------	------------------------	--------	-----	---------------------------------------

SERIE : -**1422****voor-avant-front-Vorne**

A020T609ZA75	70	8	860	860	S22	S22	118	104	8/13	A01	Silentbloc
A020T339ZA75	70	8/P	860	860	25	25	196	130	8/13+P/26	A01	
A020T267ZC75	70	8/P	860	860	25	25	155	129	8/13+P/25	A01	
A020T399ZA75	70	10	860	860	25	25	140	130	10/13	A01	
A020T677ZA75	80	14	860	860	S22	S22	176	147	14/10.5	A01	Silentbloc
A020T267ZB75	70	8/P	860	860	25	25	155	129	8/13+P/25	A01.17	
A020T417ZA75	70	11/P	860	860	25	25	192	132	11/11+P/11	A01.17	
A020T455ZA75	80	9/2/P	860	860	25	25	157	142	9/11,5+2/15+P/8	A01B	
A020T457ZA75	80	11/2	860	860	25	25	184	151	1/14+10/10,5+2/1	A01B	
A020T547ZA75	80	11/2/P	860	860	25	25	184	157	11/10,5+2/16+P/8	A01B	
F020T499ZA75	80	3	860	860	S22	S22	125	81	3/24	F01	
F020T497ZA75	80	4	860	860	S22	S22	148	93	1/21+3/20	F01	
F020T433ZA75	70	3	860	860	25	25	132	75	3/23	F01.70	
F020T431ZA75	70	3/P	860	860	25	25	145	135	3/23+P/60	F01.70	
F020T423ZA75	70	3	860	860	25	25	184	75	3/23	F01.70	
F020T493ZA75	70	4/P	860	860	25	25	218	132	4/19+P/48	F01.70	
F020T441ZA75	70	4/P	860	860	25	25	175	132	4/19+P/48	F01.70	
F020T363ZA75	80	3	860	860	25	25	145	75	3/23	F01.70	
F020T415ZA75	80	3	860	860	25	25	172	75	3/23	F01.70	
F020T405ZA75	80	4	860	860	25	25	181	85	1/20+3/19	F01.70	
F020T491ZA75	80	4	860	860	25	25	211	85	1/20+3/19	F01.70	
F020T599ZA75	90	2	800	850	30	30	-60	37	2/17	F01.70	

BESTELNR N° COMMANDE ORDER NR BESTELNR	BR LRG WID BR	BLADEN LAMES LEAVES BLATT.	B	C	D1	D2	PH FL FA SP	PAK EP TH PAK	DETAIL	MOD	OPMERKINGEN REMARKS REMARKS BEMERKUNGEN
---	------------------------	-------------------------------------	---	---	----	----	----------------------	------------------------	--------	-----	--

SERIE : -**1422****achter-arrière-rear-Hinten**

	A020T258ZB76											
A	A020T540ZA76	80	13/P/10	950	725	30	30	100	309		A01A	
	A020T540ZA75	80	13	950	725	30	30	100	169	13/13	A01	
H	A020T540HA80	80	10	770	545	--	--	11	120	10/12	A08	
A	A020T316ZB76	80	6/P/5	950	950	30	30	205	197		A01A	
	A020T316ZB75	80	6	950	950	30	30	205	102	6/17	A01	
H	A020T316HB80	80	5	750	750	--	--	140	85	5/17	A08	
A	A020T258ZA76	80	6/P/5	950	950	30	30	240	196		A01A	
	A020T258ZA75	80	6	950	950	30	30	240	96	6/16	A01	
H	A020T258HA80	80	5/P	750	750	--	--	165	100	5/16+P/20	A08	
A	A020T652ZA76	80	7/P/7	950	950	S22	S22	177	244		A01A	Silentbloc
	A020T652ZA75	80	7	950	950	S22	S22	177	112	7/16	A01	Silentbloc
H	A020T652HA80	80	7	775	775	--	--	43	112	7/16	A08	
A	A020T654ZA76	80	9/7	950	950	S22	S22	126	272		A01A	Silentbloc
	A020T654ZA75	80	9	950	950	S22	S22	125	153	9/17	A01	Silentbloc
H	A020T654HA80	80	7	750	750	--	--	0	119	7/17	A08	
A	A020T320ZB76	80	7/P/7	956	956	30	30	220	244		A01A	
	A020T320ZB75	80	7	956	956	30	30	220	112	7/16	A01	
H	A020T320HB80	80	7	770	770	--	--	120	112	7/16	A08	
A	A020T316ZA76	80	6/P/5	950	950	30	30		207	6/17+5/17+P/20	A01A.17	
	A020T316ZA75	80	6	950	950	30	30		102	6/17	A01.17	
H	A020T316HA80											
A	A020T320ZA76	80	7/P/7	956	956	30	30	220	244		A01A.17	
	A020T320ZA75	80	7	956	956	30	30	220	112	7/16	A01.17	
H	A020T320HA80	80	7	770	770	--	--	220	112	7/16	A08	
	A020T358ZA75	80	5/3	950	950	30	30	32	174	5/18+3/28	A01B	
	A020T284ZA75	80	5/2	950	950	30	30	65	150	5/18+2/30	A01B.70	
A	F020T656ZA76	80	2/P/1	950	950	S22	S22				F01A	
	F020T656ZA75	80	2	950	950					2/32	F01	
H	F020T656HA80	80	1	775	775	--	--	0	26	1/26	F08	
A	F020T528ZA76	80	2/P/1	950	950	30	30	160	116		F01A	
	F020T528ZA75	80	2	950	950	30	30	160	68	2/32	F01	
H	F020T528HA80	80	1	775	775	--	--	105	28	1/26	F08	
A	F020T370ZA76	80	2/P/2	950	950	30	30	152	134		F01A	
	F020T370ZA75	80	2	950	950	30	30	152	66	2/32	F01	
H	F020T370HA80	80	2	770	770	--	--	115	48	2/22	F08	
A	F020T584ZA76	80	2/2	950	950	S22	S22	125	122	2/32+2/25	F01A	Silentbloc
	F020T584ZA75	80	2	950	950	S22	S22	125	68	2/32	F01	Silentbloc
H	F020T584HA80	80	2	760	760	--	--	70	54	2/25	F08	
A	F020T432ZA76	80	2/P/2	950	950	30	30	160	140		F01A	
	F020T432ZA75	80	2	950	950	30	30	160	66	2/32	F01	
H	F020T432HA80	80	2	770	770	--	--	92	54	2/25	F08	

BESTELNR N° COMMANDE ORDER NR BESTELNR	BR LRG WID BR	BLADEN LAMES LEAVES BLATT.	B	C	D1	D2	PH FL FA SP	PAK EP TH PAK	DETAIL	MOD	OPMERKINGEN REMARQUES REMARKS BEMERKUNGEN
---	------------------------	-------------------------------------	---	---	----	----	----------------------	------------------------	--------	-----	--

SERIE : -

1422

	F020T658ZA76	80	3/P/2	950	950	S22	S22	187	157		F01A	
A	F020T658ZA75	80	3	950	950	S22	S22	187	79	3/25	F01	Silentbloc
H	F020T658HA80	80	2	775	775	--	--	55	58	2/27	F08	
	F020T530ZA76	80	3/P/2	950	950	30	30	207	159	3/25+P/20+2/27	F01A	
A	F020T530ZA75	80	3	950	950	30	30	205	81	3/25	F01	
H	F020T530HA80	80	2	775	775	--	--	58	58	2/27	F08	
	F020T302ZA76	80	3/P/2	950	950	30	30	195	160		F01A	
A	F020T302ZA75	80	3	950	950	30	30	195	84	3/26	F01	
H	F020T302HA80	80	2	775	775	--	--	100	56	2/26	F08	
	F020T458ZA76	80	3/P/3	950	950	30	30	205	185		F01A	
A	F020T458ZA75	80	3	950	950	30	30	205	84	3/26	F01	
H	F020T458HA80	80	3	775	775	--	--	89	81	3/25	F08	
	F020T570ZA76	80	3/3	950	950	S22	S22	180	171		F01A	Silentbloc
A	F020T570ZA75	80	3	950	950	S22	S22	180	87	3/26	F01	Silentbloc
H	F020T570HA80	80	3	760	760	--	--	70	84	3/25	F08	

BESTELNR N° COMMANDE ORDER NR BESTELNR	BR LRG WID BR	BLADEN LAMES LEAVES BLATT.	B	C	D1	D2	PH FL FA SP	PAK EP TH PAK	DETAIL	MOD	OPMERKINGEN REMARQUES REMARKS BEMERKUNGEN
---	------------------------	-------------------------------------	---	---	----	----	----------------------	------------------------	--------	-----	--

SERIE : -**1424****voor-avant-front-Vorne**

A020T609ZA75	70	8	860	860	S22	S22	118	104	8/13	A01	Silentbloc
A020T581ZA75	70	10	860	860	S22	S22	130	135	10/13.5	A01	Silentbloc
A020T677ZA75	80	14	860	860	S22	S22	176	147	14/10.5	A01	Silentbloc
F020T499ZA75	80	3	860	860	S22	S22	125	81	3/24	F01	
F020T497ZA75	80	4	860	860	S22	S22	148	93	1/21+3/20	F01	
F020T599ZA75	90	2	800	850	30	30	-60	37	2/17	F01.70	

achter-arrière-rear-Hinten

A	A020T652ZA76	80	7/P/7	950	950	S22	S22	177	244		A01A	Silentbloc
	A020T652ZA75	80	7	950	950	S22	S22	177	112	7/16	A01	Silentbloc
H	A020T652HA80	80	7	775	775	--	--	43	112	7/16	A08	
A	F020T656ZA76	80	2/P/1	950	950	S22	S22				F01A	
	F020T656ZA75	80	2	950	950					2/32	F01	
H	F020T656HA80	80	1	775	775	--	--	0	26	1/26	F08	
A	F020T584ZA76	80	2/2	950	950	S22	S22	125	122	2/32+2/25	F01A	Silentbloc
	F020T584ZA75	80	2	950	950	S22	S22	125	68	2/32	F01	Silentbloc
H	F020T584HA80	80	2	760	760	--	--	70	54	2/25	F08	
A	F020T658ZA76	80	3/P/2	950	950	S22	S22	187	157		F01A	
	F020T658ZA75	80	3	950	950	S22	S22	187	79	3/25	F01	Silentbloc
H	F020T658HA80	80	2	775	775	--	--	55	58	2/27	F08	
A	F020T570ZA76	80	3/3	950	950	S22	S22	180	171		F01A	Silentbloc
	F020T570ZA75	80	3	950	950	S22	S22	180	87	3/26	F01	Silentbloc
H	F020T570HA80	80	3	760	760	--	--	70	84	3/25	F08	

BESTELNR N° COMMANDE ORDER NR BESTELNR	BR LRG WID BR	BLADEN LAMES LEAVES BLATT.	B	C	D1	D2	PH FL FA SP	PAK EP TH PAK	DETAIL	MOD	OPMERKINGEN REMARKS BEMERKUNGEN
---	------------------------	-------------------------------------	---	---	----	----	----------------------	------------------------	--------	-----	---------------------------------------

SERIE : -**1425****voor-avant-front-Vorne**

A020T339ZA75	70	8/P	860	860	25	25	196	130	8/13+P/26	A01
A020T267ZC75	70	8/P	860	860	25	25	155	129	8/13+P/25	A01
A020T399ZA75	70	10	860	860	25	25	140	130	10/13	A01
A020T463ZA75	80	10/P	860	860	25	25	138	142	10/13+P/12	A01
A020T267ZB75	70	8/P	860	860	25	25	155	129	8/13+P/25	A01.17
A020T417ZA75	70	11/P	860	860	25	25	192	132	11/11+P/11	A01.17
A020T457ZA75	80	11/2	860	860	25	25	184	151	1/14+10/10,5+2/1	A01B
A020T547ZA75	80	11/2/P	860	860	25	25	184	157	11/10,5+2/16+P/8	A01B
F020T433ZA75	70	3	860	860	25	25	132	75	3/23	F01.70
F020T431ZA75	70	3/P	860	860	25	25	145	135	3/23+P/60	F01.70
F020T423ZA75	70	3	860	860	25	25	184	75	3/23	F01.70
F020T493ZA75	70	4/P	860	860	25	25	218	132	4/19+P/48	F01.70
F020T441ZA75	70	4/P	860	860	25	25	175	132	4/19+P/48	F01.70
F020T491ZA75	80	4	860	860	25	25	211	85	1/20+3/19	F01.70
F020T405ZA75	80	4	860	860	25	25	181	85	1/20+3/19	F01.70

BESTELNR N° COMMANDE ORDER NR BESTELNR	BR LRG WID BR	BLADEN LAMES LEAVES BLATT.	B	C	D1	D2	PH FL FA SP	PAK EP TH PAK	DETAIL	MOD	OPMERKINGEN REMARQUES REMARKS BEMERKUNGEN
---	------------------------	-------------------------------------	---	---	----	----	----------------------	------------------------	--------	-----	--

SERIE : -**1425****achter-arrière-rear-Hinten**

	A020T258ZB76										
A	A020T540ZA76	80	13/P/10	950	725	30	30	100	309		A01A
	A020T540ZA75	80	13	950	725	30	30	100	169	13/13	A01
H	A020T540HA80	80	10	770	545	--	--	11	120	10/12	A08
A	A020T258ZA76	80	6/P/5	950	950	30	30	240	196		A01A
	A020T258ZA75	80	6	950	950	30	30	240	96	6/16	A01
H	A020T258HA80	80	5/P	750	750	--	--	165	100	5/16+P/20	A08
A	A020T316ZB76	80	6/P/5	950	950	30	30	205	197		A01A
	A020T316ZB75	80	6	950	950	30	30	205	102	6/17	A01
H	A020T316HB80	80	5	750	750	--	--	140	85	5/17	A08
A	A020T320ZB76	80	7/P/7	956	956	30	30	220	244		A01A
	A020T320ZB75	80	7	956	956	30	30	220	112	7/16	A01
H	A020T320HB80	80	7	770	770	--	--	120	112	7/16	A08
A	A020T316ZA76	80	6/P/5	950	950	30	30		207	6/17+5/17+P/20	A01A.17
	A020T316ZA75	80	6	950	950	30	30		102	6/17	A01.17
H	A020T316HA80										
A	A020T320ZA76	80	7/P/7	956	956	30	30	220	244		A01A.17
	A020T320ZA75	80	7	956	956	30	30	220	112	7/16	A01.17
H	A020T320HA80	80	7	770	770	--	--	220	112	7/16	A08
	A020T358ZA75	80	5/3	950	950	30	30	32	174	5/18+3/28	A01B
	A020T284ZA75	80	5/2	950	950	30	30	65	150	5/18+2/30	A01B.70
A	F020T528ZA76	80	2/P/1	950	950	30	30	160	116		F01A
	F020T528ZA75	80	2	950	950	30	30	160	68	2/32	F01
H	F020T528HA80	80	1	775	775	--	--	105	28	1/26	F08
A	F020T432ZA76	80	2/P/2	950	950	30	30	160	140		F01A
	F020T432ZA75	80	2	950	950	30	30	160	66	2/32	F01
H	F020T432HA80	80	2	770	770	--	--	92	54	2/25	F08
A	F020T370ZA76	80	2/P/2	950	950	30	30	152	134		F01A
	F020T370ZA75	80	2	950	950	30	30	152	66	2/32	F01
H	F020T370HA80	80	2	770	770	--	--	115	48	2/22	F08
A	F020T530ZA76	80	3/P/2	950	950	30	30	207	159	3/25+P/20+2/27	F01A
	F020T530ZA75	80	3	950	950	30	30	205	81	3/25	F01
H	F020T530HA80	80	2	775	775	--	--	58	58	2/27	F08
A	F020T302ZA76	80	3/P/2	950	950	30	30	195	160		F01A
	F020T302ZA75	80	3	950	950	30	30	195	84	3/26	F01
H	F020T302HA80	80	2	775	775	--	--	100	56	2/26	F08
A	F020T458ZA76	80	3/P/3	950	950	30	30	205	185		F01A
	F020T458ZA75	80	3	950	950	30	30	205	84	3/26	F01
H	F020T458HA80	80	3	775	775	--	--	89	81	3/25	F08

BESTELNR N° COMMANDE ORDER NR BESTELNR	BR LRG WID BR	BLADEN LAMES LEAVES BLATT.	B	C	D1	D2	PH FL FA SP	PAK EP TH PAK	DETAIL	MOD	OPMERKINGEN REMARQUES REMARKS BEMERKUNGEN
---	------------------------	-------------------------------------	---	---	----	----	----------------------	------------------------	--------	-----	--

SERIE : -**1426****voor-avant-front-Vorne**

A020T677ZA75	80	14	860	860	S22	S22	176	147	14/10.5	A01	Silentbloc
F020T497ZA75	80	4	860	860	S22	S22	148	93	1/21+3/20	F01	

achter-arrière-rear-Hinten

A	A020T652ZA76	80	7/P/7	950	950	S22	S22	177	244		A01A	Silentbloc
A	A020T652ZA75	80	7	950	950	S22	S22	177	112	7/16	A01	Silentbloc
H	A020T652HA80	80	7	775	775	--	--	43	112	7/16	A08	
A	F020T656ZA76	80	2/P/1	950	950	S22	S22				F01A	
A	F020T656ZA75	80	2	950	950					2/32	F01	
H	F020T656HA80	80	1	775	775	--	--	0	26	1/26	F08	
A	F020T584ZA76	80	2/2	950	950	S22	S22	125	122	2/32+2/25	F01A	Silentbloc
A	F020T584ZA75	80	2	950	950	S22	S22	125	68	2/32	F01	Silentbloc
H	F020T584HA80	80	2	760	760	--	--	70	54	2/25	F08	

1427**voor-avant-front-Vorne**

A020T609ZA75	70	8	860	860	S22	S22	118	104	8/13	A01	Silentbloc
A020T677ZA75	80	14	860	860	S22	S22	176	147	14/10.5	A01	Silentbloc
F020T499ZA75	80	3	860	860	S22	S22	125	81	3/24	F01	
F020T497ZA75	80	4	860	860	S22	S22	148	93	1/21+3/20	F01	

achter-arrière-rear-Hinten

A	A020T652ZA76	80	7/P/7	950	950	S22	S22	177	244		A01A	Silentbloc
A	A020T652ZA75	80	7	950	950	S22	S22	177	112	7/16	A01	Silentbloc
H	A020T652HA80	80	7	775	775	--	--	43	112	7/16	A08	
A	F020T656ZA76	80	2/P/1	950	950	S22	S22				F01A	
A	F020T656ZA75	80	2	950	950					2/32	F01	
H	F020T656HA80	80	1	775	775	--	--	0	26	1/26	F08	
A	F020T584ZA76	80	2/2	950	950	S22	S22	125	122	2/32+2/25	F01A	Silentbloc
A	F020T584ZA75	80	2	950	950	S22	S22	125	68	2/32	F01	Silentbloc
H	F020T584HA80	80	2	760	760	--	--	70	54	2/25	F08	
A	F020T658ZA76	80	3/P/2	950	950	S22	S22	187	157		F01A	
A	F020T658ZA75	80	3	950	950	S22	S22	187	79	3/25	F01	Silentbloc
H	F020T658HA80	80	2	775	775	--	--	55	58	2/27	F08	
A	F020T570ZA76	80	3/3	950	950	S22	S22	180	171		F01A	Silentbloc
A	F020T570ZA75	80	3	950	950	S22	S22	180	87	3/26	F01	Silentbloc
H	F020T570HA80	80	3	760	760	--	--	70	84	3/25	F08	

BESTELNR N° COMMANDE ORDER NR BESTELNR	BR LRG WID BR	BLADEN LAMES LEAVES BLATT.	B	C	D1	D2	PH FL FA SP	PAK EP TH PAK	DETAIL	MOD	OPMERKINGEN REMARQUES REMARKS BEMERKUNGEN
---	------------------------	-------------------------------------	---	---	----	----	----------------------	------------------------	--------	-----	--

SERIE : -

1428

voor-avant-front-Vorne

A020T267ZC75	70	8/P	860	860	25	25	155	129	8/13+P/25	A01
A020T587ZA75	70	8/P	860	860	25	25		128	8/13.5+P/20	A01
A020T399ZA75	70	10	860	860	25	25	140	130	10/13	A01
A020T267ZB75	70	8/P	860	860	25	25	155	129	8/13+P/25	A01.17
F020T433ZA75	70	3	860	860	25	25	132	75	3/23	F01.70
F020T431ZA75	70	3/P	860	860	25	25	145	135	3/23+P/60	F01.70

achter-arrière-rear-Hinten

A020T412ZA76	80	9/P/10	808	808	30	30	200	237		A01A
A020T412ZA75	80	9	808	808	30	30	200	117	9/13	A01
A020T412HA80	80	10	625	625	--	--	160	100	10/10	A08
F020T556ZA76	80	3/P/2	800	800	30	30	164	143		F01A
F020T556ZA75	80	3	800	800	30	30	164	81	3/25	F01
F020T556HA80	80	2	630	630	--	--	111	42	2/19	F08

1431

voor-avant-front-Vorne

A020T609ZA75	70	8	860	860	S22	S22	118	104	8/13	A01	Silentbloc
A020T677ZA75	80	14	860	860	S22	S22	176	147	14/10.5	A01	Silentbloc
F020T499ZA75	80	3	860	860	S22	S22	125	81	3/24	F01	
F020T497ZA75	80	4	860	860	S22	S22	148	93	1/21+3/20	F01	

achter-arrière-rear-Hinten

A020T652ZA76	80	7/P/7	950	950	S22	S22	177	244		A01A	Silentbloc
A020T652ZA75	80	7	950	950	S22	S22	177	112	7/16	A01	Silentbloc
A020T652HA80	80	7	775	775	--	--	43	112	7/16	A08	
A020T654ZA76	80	9/7	950	950	S22	S22	126	272		A01A	Silentbloc
A020T654ZA75	80	9	950	950	S22	S22	125	153	9/17	A01	Silentbloc
A020T654HA80	80	7	750	750	--	--	0	119	7/17	A08	
F020T658ZA76	80	3/P/2	950	950	S22	S22	187	157		F01A	
F020T658ZA75	80	3	950	950	S22	S22	187	79	3/25	F01	Silentbloc
F020T658HA80	80	2	775	775	--	--	55	58	2/27	F08	
F020T570ZA76	80	3/3	950	950	S22	S22	180	171		F01A	Silentbloc
F020T570ZA75	80	3	950	950	S22	S22	180	87	3/26	F01	Silentbloc
F020T570HA80	80	3	760	760	--	--	70	84	3/25	F08	

BESTELNR N° COMMANDE ORDER NR BESTELNR	BR LRG WID BR	BLADEN LAMES LEAVES BLATT.	B	C	D1	D2	PH FL FA SP	PAK EP TH PAK	DETAIL	MOD	OPMERKINGEN REMARQUES REMARKS BEMERKUNGEN
---	------------------------	-------------------------------------	---	---	----	----	----------------------	------------------------	--------	-----	--

SERIE : -**1514****voor-avant-front-Vorne**

A020T657ZA75	80	8	860	860				104	8/13	A01.70	
A020T639ZA75	80	9	860	860	S19	S19	159	117	9/13	A01.70	Silentbloc
F020T537ZA75	80	3	860	860	S17	S17	214	63	3/18 - GA	F01.70	glijdop/pastille
F020T569ZA75	80	4	860	860	S19	S19	205	85	1/16+3/19 - GA	F01.70	glijdop/pastille
F020T645ZA75	80	4	860	860	S19	S19	135	89	1/17+3/20 - GA	F01.70	glijdop/pastille

achter-arrière-rear-Hinten

F020T638ZA75	80	2/2	850	850	S36	S36	90	139	1/22+1/27+2/39 -	F01B	glijdop/pastille
F020T640ZA75	80	3/2	850	850	S36	S36	116	149	1/22+2/20+2/37 -	F01B	glijdop/pastille
F020T618ZA75	80	2	850	850			0	0		F74.01	Lenker
F020T624ZA75	80	2	850	850	S36	S36		73	1/19+1/45	F74.01	Lenker
F020T852ZA75	80	2	850	975	S36	S18		86	1/35+1/43	F74.01	Silentbloc

1517**voor-avant-front-Vorne**

A020T639ZA75	80	9	860	860	S19	S19	159	117	9/13	A01.70	Silentbloc
F020T569ZA75	80	4	860	860	S19	S19	205	85	1/16+3/19 - GA	F01.70	glijdop/pastille
F020T645ZA75	80	4	860	860	S19	S19	135	89	1/17+3/20 - GA	F01.70	glijdop/pastille

achter-arrière-rear-Hinten

F020T638ZA75	80	2/2	850	850	S36	S36	90	139	1/22+1/27+2/39 -	F01B	glijdop/pastille
F020T640ZA75	80	3/2	850	850	S36	S36	116	149	1/22+2/20+2/37 -	F01B	glijdop/pastille
F020T618ZA75	80	2	850	850			0	0		F74.01	Lenker
F020T624ZA75	80	2	850	850	S36	S36		73	1/19+1/45	F74.01	Lenker
F020T852ZA75	80	2	850	975	S36	S18		86	1/35+1/43	F74.01	Silentbloc

BESTELNR N° COMMANDE ORDER NR BESTELNR	BR LRG WID BR	BLADEN LAMES LEAVES BLATT.	B	C	D1	D2	PH FL FA SP	PAK EP TH PAK	DETAIL	MOD	OPMERKINGEN REMARQUES REMARKS BEMERKUNGEN
---	------------------------	-------------------------------------	---	---	----	----	----------------------	------------------------	--------	-----	--

SERIE : -**1520****voor-avant-front-Vorne**

A020T639ZA75	80	9	860	860	S19	S19	159	117	9/13	A01.70	Silentbloc
F020T645ZA75	80	4	860	860	S19	S19	135	89	1/17+3/20 - GA	F01.70	glijdop/pastille
F020T569ZA75	80	4	860	860	S19	S19	205	85	1/16+3/19 - GA	F01.70	glijdop/pastille

achter-arrière-rear-Hinten

F020T638ZA75	80	2/2	850	850	S36	S36	90	139	1/22+1/27+2/39 -	F01B	glijdop/pastille
F020T640ZA75	80	3/2	850	850	S36	S36	116	149	1/22+2/20+2/37 -	F01B	glijdop/pastille
F020T624ZA75	80	2	850	850	S36	S36		73	1/19+1/45	F74.01	Lenker
F020T618ZA75	80	2	850	850			0	0		F74.01	Lenker
F020T852ZA75	80	2	850	975	S36	S18		86	1/35+1/43	F74.01	Silentbloc

1524**voor-avant-front-Vorne**

A020T639ZA75	80	9	860	860	S19	S19	159	117	9/13	A01.70	Silentbloc
F020T569ZA75	80	4	860	860	S19	S19	205	85	1/16+3/19 - GA	F01.70	glijdop/pastille
F020T645ZA75	80	4	860	860	S19	S19	135	89	1/17+3/20 - GA	F01.70	glijdop/pastille

achter-arrière-rear-Hinten

F020T638ZA75	80	2/2	850	850	S36	S36	90	139	1/22+1/27+2/39 -	F01B	glijdop/pastille
F020T640ZA75	80	3/2	850	850	S36	S36	116	149	1/22+2/20+2/37 -	F01B	glijdop/pastille
F020T624ZA75	80	2	850	850	S36	S36		73	1/19+1/45	F74.01	Lenker
F020T852ZA75	80	2	850	975	S36	S18		86	1/35+1/43	F74.01	Silentbloc

BESTELNR N° COMMANDE ORDER NR BESTELNR	BR LRG WID BR	BLADEN LAMES LEAVES BLATT.	B	C	D1	D2	PH FL FA SP	PAK EP TH PAK	DETAIL	MOD	OPMERKINGEN REMARQUES REMARKS BEMERKUNGEN
---	------------------------	-------------------------------------	---	---	----	----	----------------------	------------------------	--------	-----	--

SERIE : -

1614

voor-avant-front-Vorne

A020T321ZA75	80	10/P	860	860	25	25	155	140	10/13+P/10	A01
A020T281ZA75	80	10/P	860	860	25	25	155	140	10/13+P/10	A01.17
A020T455ZA75	80	9/2/P	860	860	25	25	157	142	9/11,5+2/15+P/8	A01B
A020T457ZA75	80	11/2	860	860	25	25	184	151	1/14+10/10,5+2/1	A01B
A020T547ZA75	80	11/2/P	860	860	25	25	184	157	11/10,5+2/16+P/8	A01B

achter-arrière-rear-Hinten

A	A020T400ZA76	80	9/P/9	725	950	30	30	145	268		A01A
H	A020T400ZA75	80	9	725	950	30	30	145	131	9/14,5	A01
H	A020T400HA80	80	9	525	750	--	--	40	113	9/12,5	A08
A	A020T540ZA76	80	13/P/10	950	725	30	30	100	309		A01A
H	A020T540ZA75	80	13	950	725	30	30	100	169	13/13	A01
H	A020T540HA80	80	10	770	545	--	--	11	120	10/12	A08
A	A020T316ZB76	80	6/P/5	950	950	30	30	205	197		A01A
H	A020T316ZB75	80	6	950	950	30	30	205	102	6/17	A01
H	A020T316HB80	80	5	750	750	--	--	140	85	5/17	A08
A	A020T244ZC76	80	9/7	950	950	30	30	145	272		A01A
H	A020T244ZC75	80	9	950	950	30	30	145	153	9/17	A01
H	A020T244HC80	80	7	750	750	--	--	63	119	7/17	A08
A	A020T320ZB76	80	7/P/7	956	956	30	30	220	244		A01A
H	A020T320ZB75	80	7	956	956	30	30	220	112	7/16	A01
H	A020T320HB80	80	7	770	770	--	--	120	112	7/16	A08
A	A020T316ZA76	80	6/P/5	950	950	30	30		207	6/17+5/17+P/20	A01A.17
H	A020T316ZA75	80	6	950	950	30	30		102	6/17	A01.17
H	A020T316HA80										
A	A020T320ZA76	80	7/P/7	956	956	30	30	220	244		A01A.17
H	A020T320ZA75	80	7	956	956	30	30	220	112	7/16	A01.17
H	A020T320HA80	80	7	770	770	--	--	220	112	7/16	A08
A	A020T358ZA75	80	5/3	950	950	30	30	32	174	5/18+3/28	A01B
A	F020T302ZA76	80	3/P/2	950	950	30	30	195	160		F01A
H	F020T302ZA75	80	3	950	950	30	30	195	84	3/26	F01
H	F020T302HA80	80	2	775	775	--	--	100	56	2/26	F08
A	F020T458ZA76	80	3/P/3	950	950	30	30	205	185		F01A
H	F020T458ZA75	80	3	950	950	30	30	205	84	3/26	F01
H	F020T458HA80	80	3	775	775	--	--	89	81	3/25	F08

BESTELNR N° COMMANDE ORDER NR BESTELLNR	BR LRG WID BR	BLADEN LAMES LEAVES BLATT.	B	C	D1	D2	PH FL FA SP	PAK EP TH PAK	DETAIL	MOD	OPMERKINGEN REMARQUES REMARKS BEMERKUNGEN
--	------------------------	-------------------------------------	---	---	----	----	----------------------	------------------------	--------	-----	--

SERIE : -

1617

voor-avant-front-Vorne

A020T399ZA75	70	10	860	860	25	25	140	130	10/13	A01	
A020T341ZB75	70	10	860	860	25	25	120	135	5/14+5/13	A01	
A020T321ZA75	80	10/P	860	860	25	25	155	140	10/13+P/10	A01	
A020T341ZA75	70	10	860	860	25	25	120	135	5/14+5/13	A01.17	Vervangen
A020T281ZA75	80	10/P	860	860	25	25	155	140	10/13+P/10	A01.17	
A020T455ZA75	80	9/2/P	860	860	25	25	157	142	9/11,5+2/15+P/8	A01B	
A020T457ZA75	80	11/2	860	860	25	25	184	151	1/14+10/10,5+2/1	A01B	
A020T547ZA75	80	11/2/P	860	860	25	25	184	157	11/10,5+2/16+P/8	A01B	
F020T415ZA75	80	3	860	860	25	25	172	75	3/23	F01.70	
F020T363ZA75	80	3	860	860	25	25	145	75	3/23	F01.70	
F020T477ZA75	80	4	860	860	25	25	151	96	4/22	F01.70	
F020T405ZA75	80	4	860	860	25	25	181	85	1/20+3/19	F01.70	

BESTELNR N° COMMANDE ORDER NR BESTELNR	BR LRG WID BR	BLADEN LAMES LEAVES BLATT.	B	C	D1	D2	PH FL FA SP	PAK EP TH PAK	DETAIL	MOD	OPMERKINGEN REMARQUES REMARKS BEMERKUNGEN
---	------------------------	-------------------------------------	---	---	----	----	----------------------	------------------------	--------	-----	--

SERIE : -

1617

achter-arrière-rear-Hinten

A	A020T400ZA76	80	9/P/9	725	950	30	30	145	268		A01A
	A020T400ZA75	80	9	725	950	30	30	145	131	9/14,5	A01
H	A020T400HA80	80	9	525	750	--	--	40	113	9/12,5	A08
A	A020T540ZA76	80	13/P/10	950	725	30	30	100	309		A01A
	A020T540ZA75	80	13	950	725	30	30	100	169	13/13	A01
H	A020T540HA80	80	10	770	545	--	--	11	120	10/12	A08
A	A020T316ZB76	80	6/P/5	950	950	30	30	205	197		A01A
	A020T316ZB75	80	6	950	950	30	30	205	102	6/17	A01
H	A020T316HB80	80	5	750	750	--	--	140	85	5/17	A08
A	A020T244ZC76	80	9/7	950	950	30	30	145	272		A01A
	A020T244ZC75	80	9	950	950	30	30	145	153	9/17	A01
H	A020T244HC80	80	7	750	750	--	--	63	119	7/17	A08
A	A020T320ZB76	80	7/P/7	956	956	30	30	220	244		A01A
	A020T320ZB75	80	7	956	956	30	30	220	112	7/16	A01
H	A020T320HB80	80	7	770	770	--	--	120	112	7/16	A08
A	A020T316ZA76	80	6/P/5	950	950	30	30		207	6/17+5/17+P/20	A01A.17
	A020T316ZA75	80	6	950	950	30	30		102	6/17	A01.17
H	A020T316HA80										
A	A020T320ZA76	80	7/P/7	956	956	30	30	220	244		A01A.17
	A020T320ZA75	80	7	956	956	30	30	220	112	7/16	A01.17
H	A020T320HA80	80	7	770	770	--	--	220	112	7/16	A08
	A020T358ZA75	80	5/3	950	950	30	30	32	174	5/18+3/28	A01B
	A020T284ZA75	80	5/2	950	950	30	30	65	150	5/18+2/30	A01B.70
A	F020T432ZA76	80	2/P/2	950	950	30	30	160	140		F01A
	F020T432ZA75	80	2	950	950	30	30	160	66	2/32	F01
H	F020T432HA80	80	2	770	770	--	--	92	54	2/25	F08
A	F020T370ZA76	80	2/P/2	950	950	30	30	152	134		F01A
	F020T370ZA75	80	2	950	950	30	30	152	66	2/32	F01
H	F020T370HA80	80	2	770	770	--	--	115	48	2/22	F08
A	F020T302ZA76	80	3/P/2	950	950	30	30	195	160		F01A
	F020T302ZA75	80	3	950	950	30	30	195	84	3/26	F01
H	F020T302HA80	80	2	775	775	--	--	100	56	2/26	F08
A	F020T458ZA76	80	3/P/3	950	950	30	30	205	185		F01A
	F020T458ZA75	80	3	950	950	30	30	205	84	3/26	F01
H	F020T458HA80	80	3	775	775	--	--	89	81	3/25	F08

BESTELNR N° COMMANDE ORDER NR BESTELLNR	BR LRG WID BR	BLADEN LAMES LEAVES BLATT.	B	C	D1	D2	PH FL FA SP	PAK EP TH PAK	DETAIL	MOD	OPMERKINGEN REMARQUES REMARKS BEMERKUNGEN
--	------------------------	-------------------------------------	---	---	----	----	----------------------	------------------------	--------	-----	--

SERIE : -

1620

voor-avant-front-Vorne

A020T321ZA75	80	10/P	860	860	25	25	155	140	10/13+P/10	A01
A020T281ZA75	80	10/P	860	860	25	25	155	140	10/13+P/10	A01.17
A020T455ZA75	80	9/2/P	860	860	25	25	157	142	9/11,5+2/15+P/8	A01B
A020T457ZA75	80	11/2	860	860	25	25	184	151	1/14+10/10,5+2/1	A01B
A020T547ZA75	80	11/2/P	860	860	25	25	184	157	11/10,5+2/16+P/8	A01B
F020T415ZA75	80	3	860	860	25	25	172	75	3/23	F01.70
F020T363ZA75	80	3	860	860	25	25	145	75	3/23	F01.70
F020T553ZA75	80	4	860	860	25	25	147	96	4/22	F01.70
F020T477ZA75	80	4	860	860	25	25	151	96	4/22	F01.70

BESTELNR N° COMMANDE ORDER NR BESTELNR	BR LRG WID BR	BLADEN LAMES LEAVES BLATT.	B	C	D1	D2	PH FL FA SP	PAK EP TH PAK	DETAIL	MOD	OPMERKINGEN REMARQUES REMARKS BEMERKUNGEN
---	------------------------	-------------------------------------	---	---	----	----	----------------------	------------------------	--------	-----	--

SERIE : -**1620****achter-arrière-rear-Hinten**

	A020T400ZA76	80	9/P/9	725	950	30	30	145	268		A01A
A	A020T400ZA75	80	9	725	950	30	30	145	131	9/14,5	A01
H	A020T400HA80	80	9	525	750	--	--	40	113	9/12,5	A08
	A020T540ZA76	80	13/P/10	950	725	30	30	100	309		A01A
A	A020T540ZA75	80	13	950	725	30	30	100	169	13/13	A01
H	A020T540HA80	80	10	770	545	--	--	11	120	10/12	A08
	A020T316ZB76	80	6/P/5	950	950	30	30	205	197		A01A
A	A020T316ZB75	80	6	950	950	30	30	205	102	6/17	A01
H	A020T316HB80	80	5	750	750	--	--	140	85	5/17	A08
	A020T244ZC76	80	9/7	950	950	30	30	145	272		A01A
A	A020T244ZC75	80	9	950	950	30	30	145	153	9/17	A01
H	A020T244HC80	80	7	750	750	--	--	63	119	7/17	A08
	A020T320ZB76	80	7/P/7	956	956	30	30	220	244		A01A
A	A020T320ZB75	80	7	956	956	30	30	220	112	7/16	A01
H	A020T320HB80	80	7	770	770	--	--	120	112	7/16	A08
	A020T316ZA76	80	6/P/5	950	950	30	30		207	6/17+5/17+P/20	A01A.17
A	A020T316ZA75	80	6	950	950	30	30		102	6/17	A01.17
H	A020T316HA80										
	A020T320ZA76	80	7/P/7	956	956	30	30	220	244		A01A.17
A	A020T320ZA75	80	7	956	956	30	30	220	112	7/16	A01.17
H	A020T320HA80	80	7	770	770	--	--	220	112	7/16	A08
	A020T358ZA75	80	5/3	950	950	30	30	32	174	5/18+3/28	A01B
	F020T302ZA76	80	3/P/2	950	950	30	30	195	160		F01A
A	F020T302ZA75	80	3	950	950	30	30	195	84	3/26	F01
H	F020T302HA80	80	2	775	775	--	--	100	56	2/26	F08
	F020T458ZA76	80	3/P/3	950	950	30	30	205	185		F01A
A	F020T458ZA75	80	3	950	950	30	30	205	84	3/26	F01
H	F020T458HA80	80	3	775	775	--	--	89	81	3/25	F08

BESTELNR N° COMMANDE ORDER NR BESTELLNR	BR LRG WID BR	BLADEN LAMES LEAVES BLATT.	B	C	D1	D2	PH FL FA SP	PAK EP TH PAK	DETAIL	MOD	OPMERKINGEN REMARQUES REMARKS BEMERKUNGEN
--	------------------------	-------------------------------------	---	---	----	----	----------------------	------------------------	--------	-----	--

SERIE : -**1622****voor-avant-front-Vorne**

A020T399ZA75	70	10	860	860	25	25	140	130	10/13	A01	
A020T341ZB75	70	10	860	860	25	25	120	135	5/14+5/13	A01	
A020T321ZA75	80	10/P	860	860	25	25	155	140	10/13+P/10	A01	
A020T341ZA75	70	10	860	860	25	25	120	135	5/14+5/13	A01.17	Vervangen
A020T281ZA75	80	10/P	860	860	25	25	155	140	10/13+P/10	A01.17	
A020T455ZA75	80	9/2/P	860	860	25	25	157	142	9/11,5+2/15+P/8	A01B	
A020T457ZA75	80	11/2	860	860	25	25	184	151	1/14+10/10,5+2/1	A01B	
A020T547ZA75	80	11/2/P	860	860	25	25	184	157	11/10,5+2/16+P/8	A01B	
F020T415ZA75	80	3	860	860	25	25	172	75	3/23	F01.70	
F020T363ZA75	80	3	860	860	25	25	145	75	3/23	F01.70	
F020T553ZA75	80	4	860	860	25	25	147	96	4/22	F01.70	
F020T405ZA75	80	4	860	860	25	25	181	85	1/20+3/19	F01.70	
F020T477ZA75	80	4	860	860	25	25	151	96	4/22	F01.70	

BESTELNR N° COMMANDE ORDER NR BESTELNR	BR LRG WID BR	BLADEN LAMES LEAVES BLATT.	B	C	D1	D2	PH FL FA SP	PAK EP TH PAK	DETAIL	MOD	OPMERKINGEN REMARQUES REMARKS BEMERKUNGEN
---	------------------------	-------------------------------------	---	---	----	----	----------------------	------------------------	--------	-----	--

SERIE : -**1622****achter-arrière-rear-Hinten**

	A020T400ZA76	80	9/P/9	725	950	30	30	145	268		A01A
A	A020T400ZA75	80	9	725	950	30	30	145	131	9/14,5	A01
H	A020T400HA80	80	9	525	750	--	--	40	113	9/12,5	A08
	A020T540ZA76	80	13/P/10	950	725	30	30	100	309		A01A
A	A020T540ZA75	80	13	950	725	30	30	100	169	13/13	A01
H	A020T540HA80	80	10	770	545	--	--	11	120	10/12	A08
	A020T316ZB76	80	6/P/5	950	950	30	30	205	197		A01A
A	A020T316ZB75	80	6	950	950	30	30	205	102	6/17	A01
H	A020T316HB80	80	5	750	750	--	--	140	85	5/17	A08
	A020T244ZC76	80	9/7	950	950	30	30	145	272		A01A
A	A020T244ZC75	80	9	950	950	30	30	145	153	9/17	A01
H	A020T244HC80	80	7	750	750	--	--	63	119	7/17	A08
	A020T320ZB76	80	7/P/7	956	956	30	30	220	244		A01A
A	A020T320ZB75	80	7	956	956	30	30	220	112	7/16	A01
H	A020T320HB80	80	7	770	770	--	--	120	112	7/16	A08
	A020T316ZA76	80	6/P/5	950	950	30	30		207	6/17+5/17+P/20	A01A.17
A	A020T316ZA75	80	6	950	950	30	30		102	6/17	A01.17
H	A020T316HA80										
	A020T320ZA76	80	7/P/7	956	956	30	30	220	244		A01A.17
A	A020T320ZA75	80	7	956	956	30	30	220	112	7/16	A01.17
H	A020T320HA80	80	7	770	770	--	--	220	112	7/16	A08
	A020T358ZA75	80	5/3	950	950	30	30	32	174	5/18+3/28	A01B
	A020T284ZA75	80	5/2	950	950	30	30	65	150	5/18+2/30	A01B.70
	F020T432ZA76	80	2/P/2	950	950	30	30	160	140		F01A
A	F020T432ZA75	80	2	950	950	30	30	160	66	2/32	F01
H	F020T432HA80	80	2	770	770	--	--	92	54	2/25	F08
	F020T370ZA76	80	2/P/2	950	950	30	30	152	134		F01A
A	F020T370ZA75	80	2	950	950	30	30	152	66	2/32	F01
H	F020T370HA80	80	2	770	770	--	--	115	48	2/22	F08
	F020T302ZA76	80	3/P/2	950	950	30	30	195	160		F01A
A	F020T302ZA75	80	3	950	950	30	30	195	84	3/26	F01
H	F020T302HA80	80	2	775	775	--	--	100	56	2/26	F08
	F020T458ZA76	80	3/P/3	950	950	30	30	205	185		F01A
A	F020T458ZA75	80	3	950	950	30	30	205	84	3/26	F01
H	F020T458HA80	80	3	775	775	--	--	89	81	3/25	F08

BESTELNR N° COMMANDE ORDER NR BESTELLNR	BR LRG WID BR	BLADEN LAMES LEAVES BLATT.	B	C	D1	D2	PH FL FA SP	PAK EP TH PAK	DETAIL	MOD	OPMERKINGEN REMARQUES REMARKS BEMERKUNGEN
--	------------------------	-------------------------------------	---	---	----	----	----------------------	------------------------	--------	-----	--

SERIE : -**1625****voor-avant-front-Vorne**

A020T341ZB75	70	10	860	860	25	25	120	135	5/14+5/13	A01	
A020T399ZA75	70	10	860	860	25	25	140	130	10/13	A01	
A020T321ZA75	80	10/P	860	860	25	25	155	140	10/13+P/10	A01	
A020T341ZA75	70	10	860	860	25	25	120	135	5/14+5/13	A01.17	Vervangen
A020T281ZA75	80	10/P	860	860	25	25	155	140	10/13+P/10	A01.17	
A020T455ZA75	80	9/2/P	860	860	25	25	157	142	9/11,5+2/15+P/8	A01B	
A020T457ZA75	80	11/2	860	860	25	25	184	151	1/14+10/10,5+2/1	A01B	
A020T547ZA75	80	11/2/P	860	860	25	25	184	157	11/10,5+2/16+P/8	A01B	
F020T415ZA75	80	3	860	860	25	25	172	75	3/23	F01.70	
F020T363ZA75	80	3	860	860	25	25	145	75	3/23	F01.70	
F020T405ZA75	80	4	860	860	25	25	181	85	1/20+3/19	F01.70	
F020T477ZA75	80	4	860	860	25	25	151	96	4/22	F01.70	
F020T491ZA75	80	4	860	860	25	25	211	85	1/20+3/19	F01.70	
F020T553ZA75	80	4	860	860	25	25	147	96	4/22	F01.70	

BESTELNR N° COMMANDE ORDER NR BESTELNR	BR LRG WID BR	BLADEN LAMES LEAVES BLATT.	B	C	D1	D2	PH FL FA SP	PAK EP TH PAK	DETAIL	MOD	OPMERKINGEN REMARQUES REMARKS BEMERKUNGEN
---	------------------------	-------------------------------------	---	---	----	----	----------------------	------------------------	--------	-----	--

SERIE : -**1625****achter-arrière-rear-Hinten**

	A020T400ZA76	80	9/P/9	725	950	30	30	145	268		A01A
A	A020T400ZA75	80	9	725	950	30	30	145	131	9/14,5	A01
H	A020T400HA80	80	9	525	750	--	--	40	113	9/12,5	A08
	A020T540ZA76	80	13/P/10	950	725	30	30	100	309		A01A
A	A020T540ZA75	80	13	950	725	30	30	100	169	13/13	A01
H	A020T540HA80	80	10	770	545	--	--	11	120	10/12	A08
	A020T316ZB76	80	6/P/5	950	950	30	30	205	197		A01A
A	A020T316ZB75	80	6	950	950	30	30	205	102	6/17	A01
H	A020T316HB80	80	5	750	750	--	--	140	85	5/17	A08
	A020T244ZC76	80	9/7	950	950	30	30	145	272		A01A
A	A020T244ZC75	80	9	950	950	30	30	145	153	9/17	A01
H	A020T244HC80	80	7	750	750	--	--	63	119	7/17	A08
	A020T320ZB76	80	7/P/7	956	956	30	30	220	244		A01A
A	A020T320ZB75	80	7	956	956	30	30	220	112	7/16	A01
H	A020T320HB80	80	7	770	770	--	--	120	112	7/16	A08
	A020T316ZA76	80	6/P/5	950	950	30	30		207	6/17+5/17+P/20	A01A.17
A	A020T316ZA75	80	6	950	950	30	30		102	6/17	A01.17
H	A020T316HA80										
	A020T320ZA76	80	7/P/7	956	956	30	30	220	244		A01A.17
A	A020T320ZA75	80	7	956	956	30	30	220	112	7/16	A01.17
H	A020T320HA80	80	7	770	770	--	--	220	112	7/16	A08
	A020T358ZA75	80	5/3	950	950	30	30	32	174	5/18+3/28	A01B
	A020T284ZA75	80	5/2	950	950	30	30	65	150	5/18+2/30	A01B.70
	F020T370ZA76	80	2/P/2	950	950	30	30	152	134		F01A
A	F020T370ZA75	80	2	950	950	30	30	152	66	2/32	F01
H	F020T370HA80	80	2	770	770	--	--	115	48	2/22	F08
	F020T432ZA76	80	2/P/2	950	950	30	30	160	140		F01A
A	F020T432ZA75	80	2	950	950	30	30	160	66	2/32	F01
H	F020T432HA80	80	2	770	770	--	--	92	54	2/25	F08
	F020T302ZA76	80	3/P/2	950	950	30	30	195	160		F01A
A	F020T302ZA75	80	3	950	950	30	30	195	84	3/26	F01
H	F020T302HA80	80	2	775	775	--	--	100	56	2/26	F08
	F020T458ZA76	80	3/P/3	950	950	30	30	205	185		F01A
A	F020T458ZA75	80	3	950	950	30	30	205	84	3/26	F01
H	F020T458HA80	80	3	775	775	--	--	89	81	3/25	F08

BESTELNR N° COMMANDE ORDER NR BESTELNR	BR LRG WID BR	BLADEN LAMES LEAVES BLATT.	B	C	D1	D2	PH FL FA SP	PAK EP TH PAK	DETAIL	MOD	OPMERKINGEN REMARKS REMARKS BEMERKUNGEN
---	------------------------	-------------------------------------	---	---	----	----	----------------------	------------------------	--------	-----	--

SERIE : -

1628

voor-avant-front-Vorne

A020T321ZA75	80	10/P	860	860	25	25	155	140	10/13+P/10	A01	
A020T463ZA75	80	10/P	860	860	25	25	138	142	10/13+P/12	A01	
A020T235ZB75	90	12	900	900	25	25	200	122	2/11+10/10	A01	
A020T239ZB75	90	13	900	900	25	25	130	156	13/12	A01	
A020T235ZA75	90	12	900	900	25	25	200	122	2/11+10/10	A01.16	Vervangen
A020T281ZA75	80	10/P	860	860	25	25	155	140	10/13+P/10	A01.17	
A020T457ZA75	80	11/2	860	860	25	25	184	151	1/14+10/10,5+2/1	A01B	
F020T303ZA75	90	3	900	900	25	25	163	72	3/21	F01	
F020T369ZA75	90	4	900	900	25	25	150	96	4/21	F01	
F020T299ZA75	90	4	900	900	25	25	166	90	1/21+3/19	F01	
F020T363ZA75	80	3	860	860	25	25	145	75	3/23	F01.70	
F020T477ZA75	80	4	860	860	25	25	151	96	4/22	F01.70	
F020T553ZA75	80	4	860	860	25	25	147	96	4/22	F01.70	
F020T567ZA75	90	2	750	570	30	30	-15	36	2/14	F01.70	
F020T617ZA75	90	2	750	570	30	30	24	35	2/13	F01.70	
F020T561ZA75	90	2/P	800	850	30	30	-70	50	1/16+1/18+P/13	F01.70	
F020T297ZA75	90	3	900	900	25	25	160	75	3/22	F01.70	

BESTELNR N° COMMANDE ORDER NR BESTELLNR	BR LRG WID BR	BLADEN LAMES LEAVES BLATT.	B	C	D1	D2	PH FL FA SP	PAK EP TH PAK	DETAIL	MOD	OPMERKINGEN REMARQUES REMARKS BEMERKUNGEN
--	------------------------	-------------------------------------	---	---	----	----	----------------------	------------------------	--------	-----	--

SERIE : -**1628****achter-arrière-rear-Hinten**

A	A020T400ZA76	80	9/P/9	725	950	30	30	145	268		A01A
H	A020T400ZA75	80	9	725	950	30	30	145	131	9/14,5	A01
H	A020T400HA80	80	9	525	750	--	--	40	113	9/12,5	A08
A	A020T540ZA76	80	13/P/10	950	725	30	30	100	309		A01A
H	A020T540ZA75	80	13	950	725	30	30	100	169	13/13	A01
H	A020T540HA80	80	10	770	545	--	--	11	120	10/12	A08
A	A020T316ZB76	80	6/P/5	950	950	30	30	205	197		A01A
H	A020T316ZB75	80	6	950	950	30	30	205	102	6/17	A01
H	A020T316HB80	80	5	750	750	--	--	140	85	5/17	A08
A	A020T244ZC76	80	9/7	950	950	30	30	145	272		A01A
H	A020T244ZC75	80	9	950	950	30	30	145	153	9/17	A01
H	A020T244HC80	80	7	750	750	--	--	63	119	7/17	A08
A	A020T320ZB76	80	7/P/7	956	956	30	30	220	244		A01A
H	A020T320ZB75	80	7	956	956	30	30	220	112	7/16	A01
H	A020T320HB80	80	7	770	770	--	--	120	112	7/16	A08
A	A020T270ZC76	100	8/P/6	900	900	30	30	195	212		A01A
H	A020T270ZC75	100	8	900	900	30	30	195	115	3/15+5/14	A01
H	A020T270HC80	100	6	750	750	--	--	90	84	6/14	A08
A	A020T562ZA76	100	5/P/4	950	950	30	30	150	167		A01A
H	A020T562ZA75	100	5	950	950	30	30	150	90	5/18	A01
H	A020T562HA80	100	4	760	760	--	--	70	64	4/16	A08
A	A020T316ZA76	80	6/P/5	950	950	30	30		207	6/17+5/17+P/20	A01A.17
H	A020T316ZA75	80	6	950	950	30	30		102	6/17	A01.17
H	A020T316HA80										
A	A020T320ZA76	80	7/P/7	956	956	30	30	220	244		A01A.17
H	A020T320ZA75	80	7	956	956	30	30	220	112	7/16	A01.17
H	A020T320HA80	80	7	770	770	--	--	220	112	7/16	A08
	A020T276ZA75	80	9/5	792	622	30	30	159	186	2/13+7/10+5/18	A01B
	A020T358ZA75	80	5/3	950	950	30	30	32	174	5/18+3/28	A01B
A	F020T302ZA76	80	3/P/2	950	950	30	30	195	160		F01A
H	F020T302ZA75	80	3	950	950	30	30	195	84	3/26	F01
H	F020T302HA80	80	2	775	775	--	--	100	56	2/26	F08
A	F020T458ZA76	80	3/P/3	950	950	30	30	205	185		F01A
H	F020T458ZA75	80	3	950	950	30	30	205	84	3/26	F01
H	F020T458HA80	80	3	775	775	--	--	89	81	3/25	F08
A	F020T346ZA76	100	3/P/2	900	900	30	30	165	132		F01A
H	F020T346ZA75	100	3	900	900	30	30	165	78	3/24	F01
H	F020T346HA80	100	2	740	740	--	--	124	40	2/18	F08
A	F020T628ZA76	100	3/P/2	900	900	30	30	169	124		F01A
H	F020T628ZA75	100	3	900	900	30	30	169	81	3/24	F01
H	F020T628HA80	100	2	740	740	--	--	115	48	2/21	F08

BESTELNR N° COMMANDE ORDER NR BESTELLNR	BR LRG WID BR	BLADEN LAMES LEAVES BLATT.	B	C	D1	D2	PH FL FA SP	PAK EP TH PAK	DETAIL	MOD	OPMERKINGEN REMARQUES REMARKS BEMERKUNGEN
--	------------------------	-------------------------------------	---	---	----	----	----------------------	------------------------	--------	-----	--

SERIE : -

1628

	F020T296ZA76	100	3/P/P/2	900	900	30	30	200	218		F01A
A	F020T296ZA75	100	3	900	900	30	30	200	84	3/25	F01
H	F020T296HA80	100	2	740	740	--	--	110	54	2/24	F08
	F020T456ZA76	100	3/P/3	900	900	30	30	146	179		F01A
A	F020T456ZA75	100	3	900	900	30	30	146	84	3/25	F01
H	F020T456HA80	100	3	740	740	--	--	90	81	3/24	F08
	F020T308ZA76	100	3/P/1	950	950	30	30	132	122		F01A
A	F020T308ZA75	100	3	950	950	30	30	132	84	3/26	F01
H	F020T308HA80	100	1	760	760	--	--	130	22	1/22	F08
	F020T298ZA76	100	3/P/2	950	950	30	30	160	160		F01A
A	F020T298ZA75	100	3	950	950	30	30	160	90	3/27	F01
H	F020T298HA80	100	2	760	760	--	--	80	56	2/25	F08

BESTELNR N° COMMANDE ORDER NR BESTELNR	BR LRG WID BR	BLADEN LAMES LEAVES BLATT.	B	C	D1	D2	PH FL FA SP	PAK EP TH PAK	DETAIL	MOD	OPMERKINGEN REMARQUES REMARKS BEMERKUNGEN
---	------------------------	-------------------------------------	---	---	----	----	----------------------	------------------------	--------	-----	--

SERIE : -**1633****voor-avant-front-Vorne**

A020T235ZB75	90	12	900	900	25	25	200	122	2/11+10/10	A01	
A020T239ZB75	90	13	900	900	25	25	130	156	13/12	A01	
A020T235ZA75	90	12	900	900	25	25	200	122	2/11+10/10	A01.16	Vervangen
F020T303ZA75	90	3	900	900	25	25	163	72	3/21	F01	
F020T369ZA75	90	4	900	900	25	25	150	96	4/21	F01	
F020T299ZA75	90	4	900	900	25	25	166	90	1/21+3/19	F01	
F020T567ZA75	90	2	750	570	30	30	-15	36	2/14	F01.70	
F020T561ZA75	90	2/P	800	850	30	30	-70	50	1/16+1/18+P/13	F01.70	
F020T297ZA75	90	3	900	900	25	25	160	75	3/22	F01.70	

achter-arrière-rear-Hinten

A	A020T270ZC76	100	8/P/6	900	900	30	30	195	212		A01A
H	A020T270ZC75	100	8	900	900	30	30	195	115	3/15+5/14	A01
H	A020T270HC80	100	6	750	750	--	--	90	84	6/14	A08
A	A020T562ZA76	100	5/P/4	950	950	30	30	150	167		A01A
H	A020T562ZA75	100	5	950	950	30	30	150	90	5/18	A01
H	A020T562HA80	100	4	760	760	--	--	70	64	4/16	A08
A	F020T628ZA76	100	3/P/2	900	900	30	30	169	124		F01A
H	F020T628ZA75	100	3	900	900	30	30	169	81	3/24	F01
H	F020T628HA80	100	2	740	740	--	--	115	48	2/21	F08
A	F020T346ZA76	100	3/P/2	900	900	30	30	165	132		F01A
H	F020T346ZA75	100	3	900	900	30	30	165	78	3/24	F01
H	F020T346HA80	100	2	740	740	--	--	124	40	2/18	F08
A	F020T296ZA76	100	3/P/P/2	900	900	30	30	200	218		F01A
H	F020T296ZA75	100	3	900	900	30	30	200	84	3/25	F01
H	F020T296HA80	100	2	740	740	--	--	110	54	2/24	F08
A	F020T456ZA76	100	3/P/3	900	900	30	30	146	179		F01A
H	F020T456ZA75	100	3	900	900	30	30	146	84	3/25	F01
H	F020T456HA80	100	3	740	740	--	--	90	81	3/24	F08
A	F020T308ZA76	100	3/P/1	950	950	30	30	132	122		F01A
H	F020T308ZA75	100	3	950	950	30	30	132	84	3/26	F01
H	F020T308HA80	100	1	760	760	--	--	130	22	1/22	F08
A	F020T626ZA76	100	3/P/2	950	950	30	30	168	143		F01A
H	F020T626ZA75	100	3	950	950	30	30	168	87	3/26	F01
H	F020T626HA80	100	2	765	765	--	--	108	48	2/21	F08
A	F020T298ZA76	100	3/P/2	950	950	30	30	160	160		F01A
H	F020T298ZA75	100	3	950	950	30	30	160	90	3/27	F01
H	F020T298HA80	100	2	760	760	--	--	80	56	2/25	F08

BESTELNR N° COMMANDE ORDER NR BESTELLNR	BR LRG WID BR	BLADEN LAMES LEAVES BLATT.	B	C	D1	D2	PH FL FA SP	PAK EP TH PAK	DETAIL	MOD	OPMERKINGEN REMARQUES REMARKS BEMERKUNGEN
--	------------------------	-------------------------------------	---	---	----	----	----------------------	------------------------	--------	-----	--

SERIE : -

1635

voor-avant-front-Vorne

A020T235ZB75	90	12	900	900	25	25	200	122	2/11+10/10	A01	
A020T239ZB75	90	13	900	900	25	25	130	156	13/12	A01	
A020T235ZA75	90	12	900	900	25	25	200	122	2/11+10/10	A01.16	Vervangen
F020T303ZA75	90	3	900	900	25	25	163	72	3/21	F01	
F020T611ZA75	90	3	900	900	25	25	108	78	3/23.5	F01	
F020T503ZA75	90	4	900	900	25	25	132	100	4/22	F01	
F020T369ZA75	90	4	900	900	25	25	150	96	4/21	F01	
F020T299ZA75	90	4	900	900	25	25	166	90	1/21+3/19	F01	
F020T561ZA75	90	2/P	800	850	30	30	-70	50	1/16+1/18+P/13	F01.70	

BESTELNR N° COMMANDE ORDER NR BESTELNR	BR LRG WID BR	BLADEN LAMES LEAVES BLATT.	B	C	D1	D2	PH FL FA SP	PAK EP TH PAK	DETAIL	MOD	OPMERKINGEN REMARKS REMARKS BEMERKUNGEN
---	------------------------	-------------------------------------	---	---	----	----	----------------------	------------------------	--------	-----	--

SERIE : -

1635

achter-arrière-rear-Hinten

	A020T270ZC76	100	8/P/6	900	900	30	30	195	212		A01A
A	A020T270ZC75	100	8	900	900	30	30	195	115	3/15+5/14	A01
H	A020T270HC80	100	6	750	750	--	--	90	84	6/14	A08
	A020T562ZA76	100	5/P/4	950	950	30	30	150	167		A01A
A	A020T562ZA75	100	5	950	950	30	30	150	90	5/18	A01
H	A020T562HA80	100	4	760	760	--	--	70	64	4/16	A08
	F020T628ZA76	100	3/P/2	900	900	30	30	169	124		F01A
A	F020T628ZA75	100	3	900	900	30	30	169	81	3/24	F01
H	F020T628HA80	100	2	740	740	--	--	115	48	2/21	F08
	F020T630ZA76	100	3/P/2	900	900	30	30	141	143		F01A
A	F020T630ZA75	100	3	900	900	30	30	141	87	3/27	F01
H	F020T630HA80	100	2	740	740	--	--	73	58	2/26	F08
	F020T346ZA76	100	3/P/2	900	900	30	30	165	132		F01A
A	F020T346ZA75	100	3	900	900	30	30	165	78	3/24	F01
H	F020T346HA80	100	2	740	740	--	--	124	40	2/18	F08
	F020T296ZA76	100	3/P/P/2	900	900	30	30	200	218		F01A
A	F020T296ZA75	100	3	900	900	30	30	200	84	3/25	F01
H	F020T296HA80	100	2	740	740	--	--	110	54	2/24	F08
	F020T456ZA76	100	3/P/3	900	900	30	30	146	179		F01A
A	F020T456ZA75	100	3	900	900	30	30	146	84	3/25	F01
H	F020T456HA80	100	3	740	740	--	--	90	81	3/24	F08
	F020T690ZA76	100	4/P/P/3	900	900	30	30	143	219		F01A
A	F020T690ZA75	100	4	900	900	30	30	143	104	4/24	F01
H	F020T690HA80	100	3	740	740	--	--	90	72	3/22	F08
	F020T308ZA76	100	3/P/1	950	950	30	30	132	122		F01A
A	F020T308ZA75	100	3	950	950	30	30	132	84	3/26	F01
H	F020T308HA80	100	1	760	760	--	--	130	22	1/22	F08
	F020T298ZA76	100	3/P/2	950	950	30	30	160	160		F01A
A	F020T298ZA75	100	3	950	950	30	30	160	90	3/27	F01
H	F020T298HA80	100	2	760	760	--	--	80	56	2/25	F08
	F020T626ZA76	100	3/P/2	950	950	30	30	168	143		F01A
A	F020T626ZA75	100	3	950	950	30	30	168	87	3/26	F01
H	F020T626HA80	100	2	765	765	--	--	108	48	2/21	F08

BESTELNR N° COMMANDE ORDER NR BESTELNR	BR LRG WID BR	BLADEN LAMES LEAVES BLATT.	B	C	D1	D2	PH FL FA SP	PAK EP TH PAK	DETAIL	MOD	OPMERKINGEN REMARQUES REMARKS BEMERKUNGEN
---	------------------------	-------------------------------------	---	---	----	----	----------------------	------------------------	--------	-----	--

SERIE : -

1636

voor-avant-front-Vorne

A020T235ZB75	90	12	900	900	25	25	200	122	2/11+10/10	A01	
A020T239ZB75	90	13	900	900	25	25	130	156	13/12	A01	
A020T235ZA75	90	12	900	900	25	25	200	122	2/11+10/10	A01.16	Vervangen
F020T303ZA75	90	3	900	900	25	25	163	72	3/21	F01	
F020T369ZA75	90	4	900	900	25	25	150	96	4/21	F01	
F020T299ZA75	90	4	900	900	25	25	166	90	1/21+3/19	F01	
F020T561ZA75	90	2/P	800	850	30	30	-70	50	1/16+1/18+P/13	F01.70	
F020T297ZA75	90	3	900	900	25	25	160	75	3/22	F01.70	

achter-arrière-rear-Hinten

A	A020T270ZC76	100	8/P/6	900	900	30	30	195	212		A01A
A	A020T270ZC75	100	8	900	900	30	30	195	115	3/15+5/14	A01
H	A020T270HC80	100	6	750	750	--	--	90	84	6/14	A08
A	A020T562ZA76	100	5/P/4	950	950	30	30	150	167		A01A
A	A020T562ZA75	100	5	950	950	30	30	150	90	5/18	A01
H	A020T562HA80	100	4	760	760	--	--	70	64	4/16	A08
A	F020T346ZA76	100	3/P/2	900	900	30	30	165	132		F01A
A	F020T346ZA75	100	3	900	900	30	30	165	78	3/24	F01
H	F020T346HA80	100	2	740	740	--	--	124	40	2/18	F08
A	F020T296ZA76	100	3/P/P/2	900	900	30	30	200	218		F01A
A	F020T296ZA75	100	3	900	900	30	30	200	84	3/25	F01
H	F020T296HA80	100	2	740	740	--	--	110	54	2/24	F08
A	F020T628ZA76	100	3/P/2	900	900	30	30	169	124		F01A
A	F020T628ZA75	100	3	900	900	30	30	169	81	3/24	F01
H	F020T628HA80	100	2	740	740	--	--	115	48	2/21	F08
A	F020T456ZA76	100	3/P/3	900	900	30	30	146	179		F01A
A	F020T456ZA75	100	3	900	900	30	30	146	84	3/25	F01
H	F020T456HA80	100	3	740	740	--	--	90	81	3/24	F08
A	F020T308ZA76	100	3/P/1	950	950	30	30	132	122		F01A
A	F020T308ZA75	100	3	950	950	30	30	132	84	3/26	F01
H	F020T308HA80	100	1	760	760	--	--	130	22	1/22	F08
A	F020T626ZA76	100	3/P/2	950	950	30	30	168	143		F01A
A	F020T626ZA75	100	3	950	950	30	30	168	87	3/26	F01
H	F020T626HA80	100	2	765	765	--	--	108	48	2/21	F08
A	F020T298ZA76	100	3/P/2	950	950	30	30	160	160		F01A
A	F020T298ZA75	100	3	950	950	30	30	160	90	3/27	F01
H	F020T298HA80	100	2	760	760	--	--	80	56	2/25	F08

BESTELNR N° COMMANDE ORDER NR BESTELNR	BR LRG WID BR	BLADEN LAMES LEAVES BLATT.	B	C	D1	D2	PH FL FA SP	PAK EP TH PAK	DETAIL	MOD	OPMERKINGEN REMARQUES REMARKS BEMERKUNGEN
---	------------------------	-------------------------------------	---	---	----	----	----------------------	------------------------	--------	-----	--

SERIE : -

1638

voor-avant-front-Vorne

A020T235ZB75	90	12	900	900	25	25	200	122	2/11+10/10	A01	
A020T239ZB75	90	13	900	900	25	25	130	156	13/12	A01	
A020T235ZA75	90	12	900	900	25	25	200	122	2/11+10/10	A01.16	Vervangen
F020T303ZA75	90	3	900	900	25	25	163	72	3/21	F01	
F020T369ZA75	90	4	900	900	25	25	150	96	4/21	F01	
F020T299ZA75	90	4	900	900	25	25	166	90	1/21+3/19	F01	
F020T567ZA75	90	2	750	570	30	30	-15	36	2/14	F01.70	
F020T297ZA75	90	3	900	900	25	25	160	75	3/22	F01.70	

achter-arrière-rear-Hinten

A	A020T270ZC76	100	8/P/6	900	900	30	30	195	212		A01A
H	A020T270ZC75	100	8	900	900	30	30	195	115	3/15+5/14	A01
H	A020T270HC80	100	6	750	750	--	--	90	84	6/14	A08
A	A020T562ZA76	100	5/P/4	950	950	30	30	150	167		A01A
H	A020T562ZA75	100	5	950	950	30	30	150	90	5/18	A01
H	A020T562HA80	100	4	760	760	--	--	70	64	4/16	A08
A	F020T628ZA76	100	3/P/2	900	900	30	30	169	124		F01A
H	F020T628ZA75	100	3	900	900	30	30	169	81	3/24	F01
H	F020T628HA80	100	2	740	740	--	--	115	48	2/21	F08
A	F020T346ZA76	100	3/P/2	900	900	30	30	165	132		F01A
H	F020T346ZA75	100	3	900	900	30	30	165	78	3/24	F01
H	F020T346HA80	100	2	740	740	--	--	124	40	2/18	F08
A	F020T296ZA76	100	3/P/P/2	900	900	30	30	200	218		F01A
H	F020T296ZA75	100	3	900	900	30	30	200	84	3/25	F01
H	F020T296HA80	100	2	740	740	--	--	110	54	2/24	F08
A	F020T456ZA76	100	3/P/3	900	900	30	30	146	179		F01A
H	F020T456ZA75	100	3	900	900	30	30	146	84	3/25	F01
H	F020T456HA80	100	3	740	740	--	--	90	81	3/24	F08
A	F020T308ZA76	100	3/P/1	950	950	30	30	132	122		F01A
H	F020T308ZA75	100	3	950	950	30	30	132	84	3/26	F01
H	F020T308HA80	100	1	760	760	--	--	130	22	1/22	F08
A	F020T298ZA76	100	3/P/2	950	950	30	30	160	160		F01A
H	F020T298ZA75	100	3	950	950	30	30	160	90	3/27	F01
H	F020T298HA80	100	2	760	760	--	--	80	56	2/25	F08
A	F020T626ZA76	100	3/P/2	950	950	30	30	168	143		F01A
H	F020T626ZA75	100	3	950	950	30	30	168	87	3/26	F01
H	F020T626HA80	100	2	765	765	--	--	108	48	2/21	F08

BESTELNR N° COMMANDE ORDER NR BESTELNR	BR LRG WID BR	BLADEN LAMES LEAVES BLATT.	B	C	D1	D2	PH FL FA SP	PAK EP TH PAK	DETAIL	MOD	OPMERKINGEN REMARKS BEMERKUNGEN
---	------------------------	-------------------------------------	---	---	----	----	----------------------	------------------------	--------	-----	---------------------------------------

SERIE : -**1644****voor-avant-front-Vorne**

A020T235ZB75	90	12	900	900	25	25	200	122	2/11+10/10	A01	
A020T239ZB75	90	13	900	900	25	25	130	156	13/12	A01	
A020T235ZA75	90	12	900	900	25	25	200	122	2/11+10/10	A01.16	Vervangen
F020T303ZA75	90	3	900	900	25	25	163	72	3/21	F01	
F020T369ZA75	90	4	900	900	25	25	150	96	4/21	F01	
F020T299ZA75	90	4	900	900	25	25	166	90	1/21+3/19	F01	
F020T617ZA75	90	2	750	570	30	30	24	35	2/13	F01.70	

achter-arrière-rear-Hinten

A	A020T270ZC76	100	8/P/6	900	900	30	30	195	212		A01A
H	A020T270ZC75	100	8	900	900	30	30	195	115	3/15+5/14	A01
H	A020T270HC80	100	6	750	750	--	--	90	84	6/14	A08
A	A020T562ZA76	100	5/P/4	950	950	30	30	150	167		A01A
H	A020T562ZA75	100	5	950	950	30	30	150	90	5/18	A01
H	A020T562HA80	100	4	760	760	--	--	70	64	4/16	A08
A	F020T628ZA76	100	3/P/2	900	900	30	30	169	124		F01A
H	F020T628ZA75	100	3	900	900	30	30	169	81	3/24	F01
H	F020T628HA80	100	2	740	740	--	--	115	48	2/21	F08
A	F020T346ZA76	100	3/P/2	900	900	30	30	165	132		F01A
H	F020T346ZA75	100	3	900	900	30	30	165	78	3/24	F01
H	F020T346HA80	100	2	740	740	--	--	124	40	2/18	F08
A	F020T296ZA76	100	3/P/P/2	900	900	30	30	200	218		F01A
H	F020T296ZA75	100	3	900	900	30	30	200	84	3/25	F01
H	F020T296HA80	100	2	740	740	--	--	110	54	2/24	F08
A	F020T456ZA76	100	3/P/3	900	900	30	30	146	179		F01A
H	F020T456ZA75	100	3	900	900	30	30	146	84	3/25	F01
H	F020T456HA80	100	3	740	740	--	--	90	81	3/24	F08
A	F020T308ZA76	100	3/P/1	950	950	30	30	132	122		F01A
H	F020T308ZA75	100	3	950	950	30	30	132	84	3/26	F01
H	F020T308HA80	100	1	760	760	--	--	130	22	1/22	F08
A	F020T626ZA76	100	3/P/2	950	950	30	30	168	143		F01A
H	F020T626ZA75	100	3	950	950	30	30	168	87	3/26	F01
H	F020T626HA80	100	2	765	765	--	--	108	48	2/21	F08
A	F020T298ZA76	100	3/P/2	950	950	30	30	160	160		F01A
H	F020T298ZA75	100	3	950	950	30	30	160	90	3/27	F01
H	F020T298HA80	100	2	760	760	--	--	80	56	2/25	F08

BESTELNR N° COMMANDE ORDER NR BESTELNR	BR LRG WID BR	BLADEN LAMES LEAVES BLATT.	B	C	D1	D2	PH FL FA SP	PAK EP TH PAK	DETAIL	MOD	OPMERKINGEN REMARQUES REMARKS BEMERKUNGEN
---	------------------------	-------------------------------------	---	---	----	----	----------------------	------------------------	--------	-----	--

SERIE : -

1717

voor-avant-front-Vorne

A020T581ZA75	70	10	860	860	S22	S22	130	135	10/13.5	A01	Silentbloc
A020T511ZA75	80	11	860	860	S22	S22	118	149	11/13.5	A01	
A020T677ZA75	80	14	860	860	S22	S22	176	147	14/10.5	A01	Silentbloc
A020T651ZA75	80	11/2	860	860	S22	S22	164	150	11/10.5+2/17	A01B	Silentbloc
F020T499ZA75	80	3	860	860	S22	S22	125	81	3/24	F01	
F020T501ZA75	80	4	860	860	S22	S22	115	100	4/22	F01	
F020T515ZA75	80	4	860	860	S22	S22	128	100	4/22	F01	
F020T599ZA75	90	2	800	850	30	30	-60	37	2/17	F01.70	
F020T603ZA75	90	2/P	800	850	30	30	-40	51	2/17+P/14	F01.70	

achter-arrière-rear-Hinten

	A020T652ZA76	80	7/P/7	950	950	S22	S22	177	244		A01A	Silentbloc
A	A020T652ZA75	80	7	950	950	S22	S22	177	112	7/16	A01	Silentbloc
H	A020T652HA80	80	7	775	775	--	--	43	112	7/16	A08	
	A020T654ZA76	80	9/7	950	950	S22	S22	126	272		A01A	Silentbloc
A	A020T654ZA75	80	9	950	950	S22	S22	125	153	9/17	A01	Silentbloc
H	A020T654HA80	80	7	750	750	--	--	0	119	7/17	A08	
	F020T586ZA76	80	4/4	950	725	S22	S22	140	214		F01A	Silentbloc
A	F020T586ZA75	80	4	950	725	S22	S22	140	118	4/24	F01	Silentbloc
H	F020T586HA80	80	4	770	550	--	--	45	96	4/21	F08	
	F020T570ZA76	80	3/3	950	950	S22	S22	180	171		F01A	Silentbloc
A	F020T570ZA75	80	3	950	950	S22	S22	180	87	3/26	F01	Silentbloc
H	F020T570HA80	80	3	760	760	--	--	70	84	3/25	F08	
	F020T634ZA76	80	4/3	950	950	S22	S22	150	199		F01A	Silentbloc
A	F020T634ZA75	80	4	950	950	S22	S22	150	109	1/22+3/25	F01	Silentbloc
H	F020T634HA80	80	3	760	760	--	--	40	90	3/27	F08	

BESTELNR N° COMMANDE ORDER NR BESTELNR	BR LRG WID BR	BLADEN LAMES LEAVES BLATT.	B	C	D1	D2	PH FL FA SP	PAK EP TH PAK	DETAIL	MOD	OPMERKINGEN REMARQUES REMARKS BEMERKUNGEN
---	------------------------	-------------------------------------	---	---	----	----	----------------------	------------------------	--------	-----	--

SERIE : -

1720

voor-avant-front-Vorne

A020T511ZA75	80	11	860	860	S22	S22	118	149	11/13.5	A01	
A020T677ZA75	80	14	860	860	S22	S22	176	147	14/10.5	A01	Silentbloc
F020T499ZA75	80	3	860	860	S22	S22	125	81	3/24	F01	
F020T497ZA75	80	4	860	860	S22	S22	148	93	1/21+3/20	F01	
F020T515ZA75	80	4	860	860	S22	S22	128	100	4/22	F01	

achter-arrière-rear-Hinten

	A020T652ZA76	80	7/P/7	950	950	S22	S22	177	244		A01A	Silentbloc
A	A020T652ZA75	80	7	950	950	S22	S22	177	112	7/16	A01	Silentbloc
H	A020T652HA80	80	7	775	775	--	--	43	112	7/16	A08	
	A020T654ZA76	80	9/7	950	950	S22	S22	126	272		A01A	Silentbloc
A	A020T654ZA75	80	9	950	950	S22	S22	125	153	9/17	A01	Silentbloc
H	A020T654HA80	80	7	750	750	--	--	0	119	7/17	A08	
	F020T586ZA76	80	4/4	950	725	S22	S22	140	214		F01A	Silentbloc
A	F020T586ZA75	80	4	950	725	S22	S22	140	118	4/24	F01	Silentbloc
H	F020T586HA80	80	4	770	550	--	--	45	96	4/21	F08	
	F020T584ZA76	80	2/2	950	950	S22	S22	125	122	2/32+2/25	F01A	Silentbloc
A	F020T584ZA75	80	2	950	950	S22	S22	125	68	2/32	F01	Silentbloc
H	F020T584HA80	80	2	760	760	--	--	70	54	2/25	F08	
	F020T572ZA76	80	2/3	950	950	S22	S22	125	145		F01A	Silentbloc
A	F020T572ZA75	80	2	950	950	S22	S22	125	70	2/32	F01	Silentbloc
H	F020T572HA80	80	3	775	775	--	--	73	75	3/22	F08	
	F020T570ZA76	80	3/3	950	950	S22	S22	180	171		F01A	Silentbloc
A	F020T570ZA75	80	3	950	950	S22	S22	180	87	3/26	F01	Silentbloc
H	F020T570HA80	80	3	760	760	--	--	70	84	3/25	F08	
	F020T634ZA76	80	4/3	950	950	S22	S22	150	199		F01A	Silentbloc
A	F020T634ZA75	80	4	950	950	S22	S22	150	109	1/22+3/25	F01	Silentbloc
H	F020T634HA80	80	3	760	760	--	--	40	90	3/27	F08	

BESTELNR N° COMMANDE ORDER NR BESTELNR	BR LRG WID BR	BLADEN LAMES LEAVES BLATT.	B	C	D1	D2	PH FL FA SP	PAK EP TH PAK	DETAIL	MOD	OPMERKINGEN REMARQUES REMARKS BEMERKUNGEN
---	------------------------	-------------------------------------	---	---	----	----	----------------------	------------------------	--------	-----	--

SERIE : -**1722****voor-avant-front-Vorne**

A020T695ZA75	70	10	860	860	S22	S22	169	135	10/13.5	A01	
A020T581ZA75	70	10	860	860	S22	S22	130	135	10/13.5	A01	Silentbloc
A020T511ZA75	80	11	860	860	S22	S22	118	149	11/13.5	A01	
A020T677ZA75	80	14	860	860	S22	S22	176	147	14/10.5	A01	Silentbloc
A020T651ZA75	80	11/2	860	860	S22	S22	164	150	11/10.5+2/17	A01B	Silentbloc
F020T499ZA75	80	3	860	860	S22	S22	125	81	3/24	F01	
F020T515ZA75	80	4	860	860	S22	S22	128	100	4/22	F01	
F020T501ZA75	80	4	860	860	S22	S22	115	100	4/22	F01	
F020T497ZA75	80	4	860	860	S22	S22	148	93	1/21+3/20	F01	
F020T513ZA75	90	2/P	750	650	S22	S22	-14	62	2/13+P/20	F01.70	Silentbloc
F020T599ZA75	90	2	800	850	30	30	-60	37	2/17	F01.70	
F020T603ZA75	90	2/P	800	850	30	30	-40	51	2/17+P/14	F01.70	

achter-arrière-rear-Hinten

A	A020T652ZA76	80	7/P/7	950	950	S22	S22	177	244		A01A	Silentbloc
H	A020T652ZA75	80	7	950	950	S22	S22	177	112	7/16	A01	Silentbloc
H	A020T652HA80	80	7	775	775	--	--	43	112	7/16	A08	
A	A020T654ZA76	80	9/7	950	950	S22	S22	126	272		A01A	Silentbloc
H	A020T654ZA75	80	9	950	950	S22	S22	125	153	9/17	A01	Silentbloc
H	A020T654HA80	80	7	750	750	--	--	0	119	7/17	A08	
A	F020T586ZA76	80	4/4	950	725	S22	S22	140	214		F01A	Silentbloc
H	F020T586ZA75	80	4	950	725	S22	S22	140	118	4/24	F01	Silentbloc
H	F020T586HA80	80	4	770	550	--	--	45	96	4/21	F08	
A	F020T584ZA76	80	2/2	950	950	S22	S22	125	122	2/32+2/25	F01A	Silentbloc
H	F020T584ZA75	80	2	950	950	S22	S22	125	68	2/32	F01	Silentbloc
H	F020T584HA80	80	2	760	760	--	--	70	54	2/25	F08	
A	F020T572ZA76	80	2/3	950	950	S22	S22	125	145		F01A	Silentbloc
H	F020T572ZA75	80	2	950	950	S22	S22	125	70	2/32	F01	Silentbloc
H	F020T572HA80	80	3	775	775	--	--	73	75	3/22	F08	
A	F020T570ZA76	80	3/3	950	950	S22	S22	180	171		F01A	Silentbloc
H	F020T570ZA75	80	3	950	950	S22	S22	180	87	3/26	F01	Silentbloc
H	F020T570HA80	80	3	760	760	--	--	70	84	3/25	F08	
A	F020T634ZA76	80	4/3	950	950	S22	S22	150	199		F01A	Silentbloc
H	F020T634ZA75	80	4	950	950	S22	S22	150	109	1/22+3/25	F01	Silentbloc
H	F020T634HA80	80	3	760	760	--	--	40	90	3/27	F08	

BESTELNR N° COMMANDE ORDER NR BESTELNR	BR LRG WID BR	BLADEN LAMES LEAVES BLATT.	B	C	D1	D2	PH FL FA SP	PAK EP TH PAK	DETAIL	MOD	OPMERKINGEN REMARQUES REMARKS BEMERKUNGEN
---	------------------------	-------------------------------------	---	---	----	----	----------------------	------------------------	--------	-----	--

SERIE : -

1726

voor-avant-front-Vorne

A020T581ZA75	70	10	860	860	S22	S22	130	135	10/13.5	A01	Silentbloc
A020T511ZA75	80	11	860	860	S22	S22	118	149	11/13.5	A01	
A020T677ZA75	80	14	860	860	S22	S22	176	147	14/10.5	A01	Silentbloc
A020T651ZA75	80	11/2	860	860	S22	S22	164	150	11/10.5+2/17	A01B	Silentbloc
F020T499ZA75	80	3	860	860	S22	S22	125	81	3/24	F01	
F020T515ZA75	80	4	860	860	S22	S22	128	100	4/22	F01	
F020T501ZA75	80	4	860	860	S22	S22	115	100	4/22	F01	
F020T497ZA75	80	4	860	860	S22	S22	148	93	1/21+3/20	F01	
F020T513ZA75	90	2/P	750	650	S22	S22	-14	62	2/13+P/20	F01.70	Silentbloc
F020T599ZA75	90	2	800	850	30	30	-60	37	2/17	F01.70	
F020T603ZA75	90	2/P	800	850	30	30	-40	51	2/17+P/14	F01.70	

achter-arrière-rear-Hinten

A	A020T652ZA76	80	7/P/7	950	950	S22	S22	177	244		A01A	Silentbloc
H	A020T652ZA75	80	7	950	950	S22	S22	177	112	7/16	A01	Silentbloc
H	A020T652HA80	80	7	775	775	--	--	43	112	7/16	A08	
A	A020T654ZA76	80	9/7	950	950	S22	S22	126	272		A01A	Silentbloc
H	A020T654ZA75	80	9	950	950	S22	S22	125	153	9/17	A01	Silentbloc
H	A020T654HA80	80	7	750	750	--	--	0	119	7/17	A08	
A	F020T586ZA76	80	4/4	950	725	S22	S22	140	214		F01A	Silentbloc
H	F020T586ZA75	80	4	950	725	S22	S22	140	118	4/24	F01	Silentbloc
H	F020T586HA80	80	4	770	550	--	--	45	96	4/21	F08	
A	F020T584ZA76	80	2/2	950	950	S22	S22	125	122	2/32+2/25	F01A	Silentbloc
H	F020T584ZA75	80	2	950	950	S22	S22	125	68	2/32	F01	Silentbloc
H	F020T584HA80	80	2	760	760	--	--	70	54	2/25	F08	
A	F020T572ZA76	80	2/3	950	950	S22	S22	125	145		F01A	Silentbloc
H	F020T572ZA75	80	2	950	950	S22	S22	125	70	2/32	F01	Silentbloc
H	F020T572HA80	80	3	775	775	--	--	73	75	3/22	F08	
A	F020T570ZA76	80	3/3	950	950	S22	S22	180	171		F01A	Silentbloc
H	F020T570ZA75	80	3	950	950	S22	S22	180	87	3/26	F01	Silentbloc
H	F020T570HA80	80	3	760	760	--	--	70	84	3/25	F08	
A	F020T634ZA76	80	4/3	950	950	S22	S22	150	199		F01A	Silentbloc
H	F020T634ZA75	80	4	950	950	S22	S22	150	109	1/22+3/25	F01	Silentbloc
H	F020T634HA80	80	3	760	760	--	--	40	90	3/27	F08	

BESTELNR N° COMMANDE ORDER NR BESTELNR	BR LRG WID BR	BLADEN LAMES LEAVES BLATT.	B	C	D1	D2	PH FL FA SP	PAK EP TH PAK	DETAIL	MOD	OPMERKINGEN REMARQUES REMARKS BEMERKUNGEN
---	------------------------	-------------------------------------	---	---	----	----	----------------------	------------------------	--------	-----	--

SERIE : -**1729****voor-avant-front-Vorne**

A020T311ZB75	90	9	900	900	25	25	135	117	9/13	A01	
A020T333ZA75	90	10	900	900	25	25	80	145	5/15+5/14	A01	
A020T235ZB75	90	12	900	900	25	25	200	122	2/11+10/10	A01	
A020T239ZB75	90	13	900	900	25	25	130	156	13/12	A01	
A020T243ZB75	90	10	900	900	25	25	80	145	5/15+5/14	A01.16	Vervangen
A020T235ZA75	90	12	900	900	25	25	200	122	2/11+10/10	A01.16	Vervangen
F020T611ZA75	90	3	900	900	25	25	108	78	3/23.5	F01	
F020T303ZA75	90	3	900	900	25	25	163	72	3/21	F01	
F020T369ZA75	90	4	900	900	25	25	150	96	4/21	F01	
F020T503ZA75	90	4	900	900	25	25	132	100	4/22	F01	
F020T299ZA75	90	4	900	900	25	25	166	90	1/21+3/19	F01	
F020T561ZA75	90	2/P	800	850	30	30	-70	50	1/16+1/18+P/13	F01.70	
F020T599ZA75	90	2	800	850	30	30	-60	37	2/17	F01.70	
F020T603ZA75	90	2/P	800	850	30	30	-40	51	2/17+P/14	F01.70	

BESTELNR N° COMMANDE ORDER NR BESTELNR	BR LRG WID BR	BLADEN LAMES LEAVES BLATT.	B	C	D1	D2	PH FL FA SP	PAK EP TH PAK	DETAIL	MOD	OPMERKINGEN REMARKS REMARKS BEMERKUNGEN
---	------------------------	-------------------------------------	---	---	----	----	----------------------	------------------------	--------	-----	--

SERIE : -**1729****achter-arrière-rear-Hinten**

	A020T270ZC76	100	8/P/6	900	900	30	30	195	212		A01A
A	A020T270ZC75	100	8	900	900	30	30	195	115	3/15+5/14	A01
H	A020T270HC80	100	6	750	750	--	--	90	84	6/14	A08
	A020T562ZA76	100	5/P/4	950	950	30	30	150	167		A01A
A	A020T562ZA75	100	5	950	950	30	30	150	90	5/18	A01
H	A020T562HA80	100	4	760	760	--	--	70	64	4/16	A08
	F020T628ZA76	100	3/P/2	900	900	30	30	169	124		F01A
A	F020T628ZA75	100	3	900	900	30	30	169	81	3/24	F01
H	F020T628HA80	100	2	740	740	--	--	115	48	2/21	F08
	F020T630ZA76	100	3/P/2	900	900	30	30	141	143		F01A
A	F020T630ZA75	100	3	900	900	30	30	141	87	3/27	F01
H	F020T630HA80	100	2	740	740	--	--	73	58	2/26	F08
	F020T346ZA76	100	3/P/2	900	900	30	30	165	132		F01A
A	F020T346ZA75	100	3	900	900	30	30	165	78	3/24	F01
H	F020T346HA80	100	2	740	740	--	--	124	40	2/18	F08
	F020T296ZA76	100	3/P/P/2	900	900	30	30	200	218		F01A
A	F020T296ZA75	100	3	900	900	30	30	200	84	3/25	F01
H	F020T296HA80	100	2	740	740	--	--	110	54	2/24	F08
	F020T456ZA76	100	3/P/3	900	900	30	30	146	179		F01A
A	F020T456ZA75	100	3	900	900	30	30	146	84	3/25	F01
H	F020T456HA80	100	3	740	740	--	--	90	81	3/24	F08
	F020T690ZA76	100	4/P/P/3	900	900	30	30	143	219		F01A
A	F020T690ZA75	100	4	900	900	30	30	143	104	4/24	F01
H	F020T690HA80	100	3	740	740	--	--	90	72	3/22	F08
	F020T298ZA76	100	3/P/2	950	950	30	30	160	160		F01A
A	F020T298ZA75	100	3	950	950	30	30	160	90	3/27	F01
H	F020T298HA80	100	2	760	760	--	--	80	56	2/25	F08
	F020T626ZA76	100	3/P/2	950	950	30	30	168	143		F01A
A	F020T626ZA75	100	3	950	950	30	30	168	87	3/26	F01
H	F020T626HA80	100	2	765	765	--	--	108	48	2/21	F08

BESTELNR N° COMMANDE ORDER NR BESTELNR	BR LRG WID BR	BLADEN LAMES LEAVES BLATT.	B	C	D1	D2	PH FL FA SP	PAK EP TH PAK	DETAIL	MOD	OPMERKINGEN REMARQUES REMARKS BEMERKUNGEN
---	------------------------	-------------------------------------	---	---	----	----	----------------------	------------------------	--------	-----	--

SERIE : -

1733

voor-avant-front-Vorne

A020T511ZA75	80	11	860	860	S22	S22	118	149	11/13.5	A01	
A020T677ZA75	80	14	860	860	S22	S22	176	147	14/10.5	A01	Silentbloc
F020T499ZA75	80	3	860	860	S22	S22	125	81	3/24	F01	
F020T515ZA75	80	4	860	860	S22	S22	128	100	4/22	F01	
F020T583ZA75	80	4	860	860	S22	S22	143	98	1/20+3/22	F01	
F020T497ZA75	80	4	860	860	S22	S22	148	93	1/21+3/20	F01	
F020T513ZA75	90	2/P	750	650	S22	S22	-14	62	2/13+P/20	F01.70	Silentbloc
F020T603ZA75	90	2/P	800	850	30	30	-40	51	2/17+P/14	F01.70	

achter-arrière-rear-Hinten

A	A020T652ZA76	80	7/P/7	950	950	S22	S22	177	244		A01A	Silentbloc
A	A020T652ZA75	80	7	950	950	S22	S22	177	112	7/16	A01	Silentbloc
H	A020T652HA80	80	7	775	775	--	--	43	112	7/16	A08	
A	A020T654ZA76	80	9/7	950	950	S22	S22	126	272		A01A	Silentbloc
A	A020T654ZA75	80	9	950	950	S22	S22	125	153	9/17	A01	Silentbloc
H	A020T654HA80	80	7	750	750	--	--	0	119	7/17	A08	
A	F020T586ZA76	80	4/4	950	725	S22	S22	140	214		F01A	Silentbloc
A	F020T586ZA75	80	4	950	725	S22	S22	140	118	4/24	F01	Silentbloc
H	F020T586HA80	80	4	770	550	--	--	45	96	4/21	F08	
A	F020T584ZA76	80	2/2	950	950	S22	S22	125	122	2/32+2/25	F01A	Silentbloc
A	F020T584ZA75	80	2	950	950	S22	S22	125	68	2/32	F01	Silentbloc
H	F020T584HA80	80	2	760	760	--	--	70	54	2/25	F08	
A	F020T572ZA76	80	2/3	950	950	S22	S22	125	145		F01A	Silentbloc
A	F020T572ZA75	80	2	950	950	S22	S22	125	70	2/32	F01	Silentbloc
H	F020T572HA80	80	3	775	775	--	--	73	75	3/22	F08	
A	F020T570ZA76	80	3/3	950	950	S22	S22	180	171		F01A	Silentbloc
A	F020T570ZA75	80	3	950	950	S22	S22	180	87	3/26	F01	Silentbloc
H	F020T570HA80	80	3	760	760	--	--	70	84	3/25	F08	
A	F020T634ZA76	80	4/3	950	950	S22	S22	150	199		F01A	Silentbloc
A	F020T634ZA75	80	4	950	950	S22	S22	150	109	1/22+3/25	F01	Silentbloc
H	F020T634HA80	80	3	760	760	--	--	40	90	3/27	F08	

BESTELNR N° COMMANDE ORDER NR BESTELNR	BR LRG WID BR	BLADEN LAMES LEAVES BLATT.	B	C	D1	D2	PH FL FA SP	PAK EP TH PAK	DETAIL	MOD	OPMERKINGEN REMARQUES REMARKS BEMERKUNGEN
---	------------------------	-------------------------------------	---	---	----	----	----------------------	------------------------	--------	-----	--

SERIE : -**1735****voor-avant-front-Vorne**

A020T311ZB75	90	9	900	900	25	25	135	117	9/13	A01	
A020T333ZA75	90	10	900	900	25	25	80	145	5/15+5/14	A01	
A020T235ZB75	90	12	900	900	25	25	200	122	2/11+10/10	A01	
A020T239ZB75	90	13	900	900	25	25	130	156	13/12	A01	
A020T243ZB75	90	10	900	900	25	25	80	145	5/15+5/14	A01.16	Vervangen
A020T235ZA75	90	12	900	900	25	25	200	122	2/11+10/10	A01.16	Vervangen
F020T611ZA75	90	3	900	900	25	25	108	78	3/23.5	F01	
F020T303ZA75	90	3	900	900	25	25	163	72	3/21	F01	
F020T369ZA75	90	4	900	900	25	25	150	96	4/21	F01	
F020T299ZA75	90	4	900	900	25	25	166	90	1/21+3/19	F01	
F020T503ZA75	90	4	900	900	25	25	132	100	4/22	F01	
F020T603ZA75	90	2/P	800	850	30	30	-40	51	2/17+P/14	F01.70	
F020T561ZA75	90	2/P	800	850	30	30	-70	50	1/16+1/18+P/13	F01.70	

BESTELNR N° COMMANDE ORDER NR BESTELNR	BR LRG WID BR	BLADEN LAMES LEAVES BLATT.	B	C	D1	D2	PH FL FA SP	PAK EP TH PAK	DETAIL	MOD	OPMERKINGEN REMARKS REMARKS BEMERKUNGEN
---	------------------------	-------------------------------------	---	---	----	----	----------------------	------------------------	--------	-----	--

SERIE : -

1735

achter-arrière-rear-Hinten

	A020T270ZC76	100	8/P/6	900	900	30	30	195	212		A01A
A	A020T270ZC75	100	8	900	900	30	30	195	115	3/15+5/14	A01
H	A020T270HC80	100	6	750	750	--	--	90	84	6/14	A08
	A020T562ZA76	100	5/P/4	950	950	30	30	150	167		A01A
A	A020T562ZA75	100	5	950	950	30	30	150	90	5/18	A01
H	A020T562HA80	100	4	760	760	--	--	70	64	4/16	A08
	F020T346ZA76	100	3/P/2	900	900	30	30	165	132		F01A
A	F020T346ZA75	100	3	900	900	30	30	165	78	3/24	F01
H	F020T346HA80	100	2	740	740	--	--	124	40	2/18	F08
	F020T296ZA76	100	3/P/P/2	900	900	30	30	200	218		F01A
A	F020T296ZA75	100	3	900	900	30	30	200	84	3/25	F01
H	F020T296HA80	100	2	740	740	--	--	110	54	2/24	F08
	F020T628ZA76	100	3/P/2	900	900	30	30	169	124		F01A
A	F020T628ZA75	100	3	900	900	30	30	169	81	3/24	F01
H	F020T628HA80	100	2	740	740	--	--	115	48	2/21	F08
	F020T630ZA76	100	3/P/2	900	900	30	30	141	143		F01A
A	F020T630ZA75	100	3	900	900	30	30	141	87	3/27	F01
H	F020T630HA80	100	2	740	740	--	--	73	58	2/26	F08
	F020T456ZA76	100	3/P/3	900	900	30	30	146	179		F01A
A	F020T456ZA75	100	3	900	900	30	30	146	84	3/25	F01
H	F020T456HA80	100	3	740	740	--	--	90	81	3/24	F08
	F020T690ZA76	100	4/P/P/3	900	900	30	30	143	219		F01A
A	F020T690ZA75	100	4	900	900	30	30	143	104	4/24	F01
H	F020T690HA80	100	3	740	740	--	--	90	72	3/22	F08
	F020T626ZA76	100	3/P/2	950	950	30	30	168	143		F01A
A	F020T626ZA75	100	3	950	950	30	30	168	87	3/26	F01
H	F020T626HA80	100	2	765	765	--	--	108	48	2/21	F08
	F020T298ZA76	100	3/P/2	950	950	30	30	160	160		F01A
A	F020T298ZA75	100	3	950	950	30	30	160	90	3/27	F01
H	F020T298HA80	100	2	760	760	--	--	80	56	2/25	F08

BESTELNR N° COMMANDE ORDER NR BESTELNR	BR LRG WID BR	BLADEN LAMES LEAVES BLATT.	B	C	D1	D2	PH FL FA SP	PAK EP TH PAK	DETAIL	MOD	OPMERKINGEN REMARQUES REMARKS BEMERKUNGEN
---	------------------------	-------------------------------------	---	---	----	----	----------------------	------------------------	--------	-----	--

SERIE : -

1748

voor-avant-front-Vorne

F020T303ZA75	90	3	900	900	25	25	163	72	3/21	F01
F020T595ZA75	90	4	900	900	S24	S24	152	104	4/23	F01
F020T299ZA75	90	4	900	900	25	25	166	90	1/21+3/19	F01
F020T369ZA75	90	4	900	900	25	25	150	96	4/21	F01
F020T591ZA75	90	4	900	900	S24	S24	150	96	4/21	F01
F020T585ZA75	90	4	900	900	S24	S24	179	92	4/20	F01
F020T603ZA75	90	2/P	800	850	30	30	-40	51	2/17+P/14	F01.70
F020T297ZA75	90	3	900	900	25	25	160	75	3/22	F01.70

achter-arrière-rear-Hinten

A	F020T628ZA76	100	3/P/2	900	900	30	30	169	124		F01A
H	F020T628ZA75	100	3	900	900	30	30	169	81	3/24	F01
H	F020T628HA80	100	2	740	740	--	--	115	48	2/21	F08
A	F020T750ZA76	100	3/P/2	900	900	S24	S24	169	138	3/24+2/21	F01A Silentbloc
H	F020T750ZA75	100	3	900	900	S24	S24	169	78	3/24	F01 Silentbloc
H	F020T750HA80	100	2	740	740	--	--	130	46	2/21	F08
A	F020T746ZA76	100	3/P/P/2	900	900	S24	S24	195	213		F01A Silentbloc
H	F020T746ZA75	100	3	900	900	S24	S24	195	81	2/25	F01 Silentbloc
H	F020T746HA80	100	2	740	740	--	--	129	52	2/24	F08
A	F020T296ZA76	100	3/P/P/2	900	900	30	30	200	218		F01A
H	F020T296ZA75	100	3	900	900	30	30	200	84	3/25	F01
H	F020T296HA80	100	2	740	740	--	--	110	54	2/24	F08
A	F020T456ZA76	100	3/P/3	900	900	30	30	146	179		F01A
H	F020T456ZA75	100	3	900	900	30	30	146	84	3/25	F01
H	F020T456HA80	100	3	740	740	--	--	90	81	3/24	F08
A	F020T678ZA76	100	3/P/2	950	950	S24	S24	160	155		F01A Silentbloc
H	F020T678ZA75	100	3	950	950	S24	S24	160	87	3/27	F01 Silentbloc
H	F020T678HA80	100	2	760	760	--	--	85	54	2/25	F08
A	F020T626ZA76	100	3/P/2	950	950	30	30	168	143		F01A
H	F020T626ZA75	100	3	950	950	30	30	168	87	3/26	F01
H	F020T626HA80	100	2	765	765	--	--	108	48	2/21	F08
A	F020T298ZA76	100	3/P/2	950	950	30	30	160	160		F01A
H	F020T298ZA75	100	3	950	950	30	30	160	90	3/27	F01
H	F020T298HA80	100	2	760	760	--	--	80	56	2/25	F08
A	F020T748ZA76	100	3/P/2	950	950	S24	S24	172	143		F01A Silentbloc
H	F020T748ZA75	100	3	950	950	S24	S24	172	84	3/26	F01 Silentbloc
H	F020T748HA80	100	2	765	765	--	--	145	48	2/21	F08

BESTELNR N° COMMANDE ORDER NR BESTELNR	BR LRG WID BR	BLADEN LAMES LEAVES BLATT.	B	C	D1	D2	PH FL FA SP	PAK EP TH PAK	DETAIL	MOD	OPMERKINGEN REMARQUES REMARKS BEMERKUNGEN
---	------------------------	-------------------------------------	---	---	----	----	----------------------	------------------------	--------	-----	--

SERIE : -

1820

voor-avant-front-Vorne

A020T511ZA75	80	11	860	860	S22	S22	118	149	11/13.5	A01	
A020T677ZA75	80	14	860	860	S22	S22	176	147	14/10.5	A01	Silentbloc
F020T499ZA75	80	3	860	860	S22	S22	125	81	3/24	F01	
F020T515ZA75	80	4	860	860	S22	S22	128	100	4/22	F01	

achter-arrière-rear-Hinten

	A020T652ZA76	80	7/P/7	950	950	S22	S22	177	244		A01A	Silentbloc
A	A020T652ZA75	80	7	950	950	S22	S22	177	112	7/16	A01	Silentbloc
H	A020T652HA80	80	7	775	775	--	--	43	112	7/16	A08	
	A020T654ZA76	80	9/7	950	950	S22	S22	126	272		A01A	Silentbloc
A	A020T654ZA75	80	9	950	950	S22	S22	125	153	9/17	A01	Silentbloc
H	A020T654HA80	80	7	750	750	--	--	0	119	7/17	A08	
	F020T586ZA76	80	4/4	950	725	S22	S22	140	214		F01A	Silentbloc
A	F020T586ZA75	80	4	950	725	S22	S22	140	118	4/24	F01	Silentbloc
H	F020T586HA80	80	4	770	550	--	--	45	96	4/21	F08	
	F020T570ZA76	80	3/3	950	950	S22	S22	180	171		F01A	Silentbloc
A	F020T570ZA75	80	3	950	950	S22	S22	180	87	3/26	F01	Silentbloc
H	F020T570HA80	80	3	760	760	--	--	70	84	3/25	F08	
	F020T634ZA76	80	4/3	950	950	S22	S22	150	199		F01A	Silentbloc
A	F020T634ZA75	80	4	950	950	S22	S22	150	109	1/22+3/25	F01	Silentbloc
H	F020T634HA80	80	3	760	760	--	--	40	90	3/27	F08	

BESTELNR N° COMMANDE ORDER NR BESTELLNR	BR LRG WID BR	BLADEN LAMES LEAVES BLATT.	B	C	D1	D2	PH FL FA SP	PAK EP TH PAK	DETAIL	MOD	OPMERKINGEN REMARQUES REMARKS BEMERKUNGEN
--	------------------------	-------------------------------------	---	---	----	----	----------------------	------------------------	--------	-----	--

SERIE : -

1824

voor-avant-front-Vorne

A020T695ZA75	70	10	860	860	S22	S22	169	135	10/13.5	A01	
A020T511ZA75	80	11	860	860	S22	S22	118	149	11/13.5	A01	
A020T677ZA75	80	14	860	860	S22	S22	176	147	14/10.5	A01	Silentbloc
A020T651ZA75	80	11/2	860	860	S22	S22	164	150	11/10.5+2/17	A01B	Silentbloc
F020T499ZA75	80	3	860	860	S22	S22	125	81	3/24	F01	
F020T515ZA75	80	4	860	860	S22	S22	128	100	4/22	F01	
F020T583ZA75	80	4	860	860	S22	S22	143	98	1/20+3/22	F01	
F020T501ZA75	80	4	860	860	S22	S22	115	100	4/22	F01	

achter-arrière-rear-Hinten

A	A020T652ZA76	80	7/P/7	950	950	S22	S22	177	244		A01A	Silentbloc
A	A020T652ZA75	80	7	950	950	S22	S22	177	112	7/16	A01	Silentbloc
H	A020T652HA80	80	7	775	775	--	--	43	112	7/16	A08	
A	A020T654ZA76	80	9/7	950	950	S22	S22	126	272		A01A	Silentbloc
A	A020T654ZA75	80	9	950	950	S22	S22	125	153	9/17	A01	Silentbloc
H	A020T654HA80	80	7	750	750	--	--	0	119	7/17	A08	
A	F020T586ZA76	80	4/4	950	725	S22	S22	140	214		F01A	Silentbloc
A	F020T586ZA75	80	4	950	725	S22	S22	140	118	4/24	F01	Silentbloc
H	F020T586HA80	80	4	770	550	--	--	45	96	4/21	F08	
A	F020T570ZA76	80	3/3	950	950	S22	S22	180	171		F01A	Silentbloc
A	F020T570ZA75	80	3	950	950	S22	S22	180	87	3/26	F01	Silentbloc
H	F020T570HA80	80	3	760	760	--	--	70	84	3/25	F08	
A	F020T634ZA76	80	4/3	950	950	S22	S22	150	199		F01A	Silentbloc
A	F020T634ZA75	80	4	950	950	S22	S22	150	109	1/22+3/25	F01	Silentbloc
H	F020T634HA80	80	3	760	760	--	--	40	90	3/27	F08	

BESTELNR N° COMMANDE ORDER NR BESTELNR	BR LRG WID BR	BLADEN LAMES LEAVES BLATT.	B	C	D1	D2	PH FL FA SP	PAK EP TH PAK	DETAIL	MOD	OPMERKINGEN REMARQUES REMARKS BEMERKUNGEN
---	------------------------	-------------------------------------	---	---	----	----	----------------------	------------------------	--------	-----	--

SERIE : -**1827****voor-avant-front-Vorne**

A020T695ZA75	70	10	860	860	S22	S22	169	135	10/13.5	A01	
A020T511ZA75	80	11	860	860	S22	S22	118	149	11/13.5	A01	
A020T677ZA75	80	14	860	860	S22	S22	176	147	14/10.5	A01	Silentbloc
A020T651ZA75	80	11/2	860	860	S22	S22	164	150	11/10.5+2/17	A01B	Silentbloc
F020T499ZA75	80	3	860	860	S22	S22	125	81	3/24	F01	
F020T583ZA75	80	4	860	860	S22	S22	143	98	1/20+3/22	F01	
F020T497ZA75	80	4	860	860	S22	S22	148	93	1/21+3/20	F01	
F020T515ZA75	80	4	860	860	S22	S22	128	100	4/22	F01	
F020T501ZA75	80	4	860	860	S22	S22	115	100	4/22	F01	
F020T513ZA75	90	2/P	750	650	S22	S22	-14	62	2/13+P/20	F01.70	Silentbloc

achter-arrière-rear-Hinten

A	A020T652ZA76	80	7/P/7	950	950	S22	S22	177	244		A01A	Silentbloc
A	A020T652ZA75	80	7	950	950	S22	S22	177	112	7/16	A01	Silentbloc
H	A020T652HA80	80	7	775	775	--	--	43	112	7/16	A08	
A	A020T654ZA76	80	9/7	950	950	S22	S22	126	272		A01A	Silentbloc
A	A020T654ZA75	80	9	950	950	S22	S22	125	153	9/17	A01	Silentbloc
H	A020T654HA80	80	7	750	750	--	--	0	119	7/17	A08	
	F020T676ZA75	80	6	790	620	S22	S22	73	156	6/23	F01	Silentbloc
A	F020T586ZA76	80	4/4	950	725	S22	S22	140	214		F01A	Silentbloc
A	F020T586ZA75	80	4	950	725	S22	S22	140	118	4/24	F01	Silentbloc
H	F020T586HA80	80	4	770	550	--	--	45	96	4/21	F08	
A	F020T584ZA76	80	2/2	950	950	S22	S22	125	122	2/32+2/25	F01A	Silentbloc
A	F020T584ZA75	80	2	950	950	S22	S22	125	68	2/32	F01	Silentbloc
H	F020T584HA80	80	2	760	760	--	--	70	54	2/25	F08	
A	F020T570ZA76	80	3/3	950	950	S22	S22	180	171		F01A	Silentbloc
A	F020T570ZA75	80	3	950	950	S22	S22	180	87	3/26	F01	Silentbloc
H	F020T570HA80	80	3	760	760	--	--	70	84	3/25	F08	
A	F020T634ZA76	80	4/3	950	950	S22	S22	150	199		F01A	Silentbloc
A	F020T634ZA75	80	4	950	950	S22	S22	150	109	1/22+3/25	F01	Silentbloc
H	F020T634HA80	80	3	760	760	--	--	40	90	3/27	F08	

BESTELNR N° COMMANDE ORDER NR BESTELNR	BR LRG WID BR	BLADEN LAMES LEAVES BLATT.	B	C	D1	D2	PH FL FA SP	PAK EP TH PAK	DETAIL	MOD	OPMERKINGEN REMARKS REMARKS BEMERKUNGEN
---	------------------------	-------------------------------------	---	---	----	----	----------------------	------------------------	--------	-----	--

SERIE : -**1831****voor-avant-front-Vorne**

A020T511ZA75	80	11	860	860	S22	S22	118	149	11/13.5	A01	
A020T677ZA75	80	14	860	860	S22	S22	176	147	14/10.5	A01	Silentbloc
A020T311ZB75	90	9	900	900	25	25	135	117	9/13	A01	
A020T333ZA75	90	10	900	900	25	25	80	145	5/15+5/14	A01	
A020T607ZA75	90	10	900	900	S24	S24	75	145	5/15+5/14	A01	Silentbloc
A020T615ZA75	90	13	900	900	S24	S24	120	158	2/13+11/12	A01	Silentbloc
A020T485ZA75	90	14	900	900	25	25	65	198	2/15+12/14	A01	
A020T623ZA75	90	14	900	900	S24	S24	70	198	2/15+12/14	A01	Silentbloc
A020T243ZB75	90	10	900	900	25	25	80	145	5/15+5/14	A01.16	Vervangen
F020T499ZA75	80	3	860	860	S22	S22	125	81	3/24	F01	
F020T497ZA75	80	4	860	860	S22	S22	148	93	1/21+3/20	F01	
F020T515ZA75	80	4	860	860	S22	S22	128	100	4/22	F01	
F020T583ZA75	80	4	860	860	S22	S22	143	98	1/20+3/22	F01	
F020T611ZA75	90	3	900	900	25	25	108	78	3/23.5	F01	
F020T303ZA75	90	3	900	900	25	25	163	72	3/21	F01	
F020T585ZA75	90	4	900	900	S24	S24	179	92	4/20	F01	
F020T369ZA75	90	4	900	900	25	25	150	96	4/21	F01	
F020T299ZA75	90	4	900	900	25	25	166	90	1/21+3/19	F01	
F020T591ZA75	90	4	900	900	S24	S24	150	96	4/21	F01	
F020T595ZA75	90	4	900	900	S24	S24	152	104	4/23	F01	
F020T503ZA75	90	4	900	900	25	25	132	100	4/22	F01	
F020T655ZA75	90	4	900	900	S24	S24	128	100	4/22	F01	

BESTELNR N° COMMANDE ORDER NR BESTELLNR	BR LRG WID BR	BLADEN LAMES LEAVES BLATT.	B	C	D1	D2	PH FL FA SP	PAK EP TH PAK	DETAIL	MOD	OPMERKINGEN REMARKS REMARKS BEMERKUNGEN
--	------------------------	-------------------------------------	---	---	----	----	----------------------	------------------------	--------	-----	--

SERIE : -

1831

achter-arrière-rear-Hinten

A	A020T652ZA76	80	7/P/7	950	950	S22	S22	177	244		A01A	Silentbloc
H	A020T652ZA75	80	7	950	950	S22	S22	177	112	7/16	A01	Silentbloc
H	A020T652HA80	80	7	775	775	--	--	43	112	7/16	A08	
A	A020T654ZA76	80	9/7	950	950	S22	S22	126	272		A01A	Silentbloc
H	A020T654ZA75	80	9	950	950	S22	S22	125	153	9/17	A01	Silentbloc
H	A020T654HA80	80	7	750	750	--	--	0	119	7/17	A08	
A	A020T740ZA76	100	8/P/6	900	900	S24	S24	195	212		A01A	Silentbloc
H	A020T740ZA75	100	8	900	900	S24	S24		115	3/15+5/14	A01	Silentbloc
H	A020T740HA80	100	6	750	750			90	84	6/14	A08	
A	A020T270ZC76	100	8/P/6	900	900	30	30	195	212		A01A	
H	A020T270ZC75	100	8	900	900	30	30	195	115	3/15+5/14	A01	
H	A020T270HC80	100	6	750	750	--	--	90	84	6/14	A08	
A	A020T684ZA76	100	9/P/7	900	900	S24	S24	170	242		A01A	Silentbloc
H	A020T684ZA75	100	9	900	900	S24	S24	170	130	4/15+5/14	A01	Silentbloc
H	A020T684HA80	100	7	745	745	--	--	80	98	7/14	A08	
A	A020T310ZC76	100	9/P/7	900	900	30	30	170	242		A01A	
H	A020T310ZC75	100	9	900	900	30	30	170	130	4/15+5/14	A01	
H	A020T310HC80	100	7	770	770	--	--	70	98	7/14	A08	
A	A020T310ZB76	100	9/P/7	900	900	30	30	170	242		A01A.17	
H	A020T310ZB75	100	9	900	900	30	30	170	130	4/15+5/14	A01.17	
H	A020T310HB80	100	7	770	770	--	--	70	98	7/14	A08	
	F020T834ZA75	100	6	780	620	S24	30		144	6/22	F01	
A	F020T586ZA76	80	4/4	950	725	S22	S22	140	214		F01A	Silentbloc
H	F020T586ZA75	80	4	950	725	S22	S22	140	118	4/24	F01	Silentbloc
H	F020T586HA80	80	4	770	550	--	--	45	96	4/21	F08	
A	F020T584ZA76	80	2/2	950	950	S22	S22	125	122	2/32+2/25	F01A	Silentbloc
H	F020T584ZA75	80	2	950	950	S22	S22	125	68	2/32	F01	Silentbloc
H	F020T584HA80	80	2	760	760	--	--	70	54	2/25	F08	
A	F020T572ZA76	80	2/3	950	950	S22	S22	125	145		F01A	Silentbloc
H	F020T572ZA75	80	2	950	950	S22	S22	125	70	2/32	F01	Silentbloc
H	F020T572HA80	80	3	775	775	--	--	73	75	3/22	F08	
A	F020T570ZA76	80	3/3	950	950	S22	S22	180	171		F01A	Silentbloc
H	F020T570ZA75	80	3	950	950	S22	S22	180	87	3/26	F01	Silentbloc
H	F020T570HA80	80	3	760	760	--	--	70	84	3/25	F08	
A	F020T634ZA76	80	4/3	950	950	S22	S22	150	199		F01A	Silentbloc
H	F020T634ZA75	80	4	950	950	S22	S22	150	109	1/22+3/25	F01	Silentbloc
H	F020T634HA80	80	3	760	760	--	--	40	90	3/27	F08	
A	F020T296ZA76	100	3/P/P/2	900	900	30	30	200	218		F01A	
H	F020T296ZA75	100	3	900	900	30	30	200	84	3/25	F01	
H	F020T296HA80	100	2	740	740	--	--	110	54	2/24	F08	
A	F020T630ZA76	100	3/P/2	900	900	30	30	141	143		F01A	
H	F020T630ZA75	100	3	900	900	30	30	141	87	3/27	F01	
H	F020T630HA80	100	2	740	740	--	--	73	58	2/26	F08	

BESTELNR N° COMMANDE ORDER NR BESTELNR	BR LRG WID BR	BLADEN LAMES LEAVES BLATT.	B	C	D1	D2	PH FL FA SP	PAK EP TH PAK	DETAIL	MOD	OPMERKINGEN REMARQUES REMARKS BEMERKUNGEN
---	------------------------	-------------------------------------	---	---	----	----	----------------------	------------------------	--------	-----	--

SERIE : -**1831**

A	F020T750ZA76	100	3/P/2	900	900	S24	S24	169	138	3/24+2/21	F01A	Silentbloc
	F020T750ZA75	100	3	900	900	S24	S24	169	78	3/24	F01	Silentbloc
H	F020T750HA80	100	2	740	740	--	--	130	46	2/21	F08	
A	F020T752ZA76	100	3/P/2	900	900	S24	S24		0		F01A	Silentbloc
	F020T752ZA75	100	3	900	900	S24	S24		0		F01	Silentbloc
H	F020T752HA80	100	2	0	0	--	--		0		F08	
A	F020T746ZA76	100	3/P/P/2	900	900	S24	S24	195	213		F01A	Silentbloc
	F020T746ZA75	100	3	900	900	S24	S24	195	81	2/25	F01	Silentbloc
H	F020T746HA80	100	2	740	740	--	--	129	52	2/24	F08	
A	F020T628ZA76	100	3/P/2	900	900	30	30	169	124		F01A	
	F020T628ZA75	100	3	900	900	30	30	169	81	3/24	F01	
H	F020T628HA80	100	2	740	740	--	--	115	48	2/21	F08	
A	F020T724ZA76	100	3/P/3	900	900	S24	S24	145	173		F01A	Silentbloc
	F020T724ZA75	100	3	900	900	S24	S24	145	81	3/25	F01	Silentbloc
H	F020T724HA80	100	3	740	740	--	--	96	78	3/24	F08	
A	F020T456ZA76	100	3/P/3	900	900	30	30	146	179		F01A	
	F020T456ZA75	100	3	900	900	30	30	146	84	3/25	F01	
H	F020T456HA80	100	3	740	740	--	--	90	81	3/24	F08	
A	F020T682ZA76	100	4/P/P/3	900	900	S24	S24	147	220		F01A	Silentbloc
	F020T682ZA75	100	4	900	900	S24	S24	147	104	4/24	F01	Silentbloc
H	F020T682HA80	100	3	740	740	--	--	85	72	3/22	F08	
A	F020T690ZA76	100	4/P/P/3	900	900	30	30	143	219		F01A	
	F020T690ZA75	100	4	900	900	30	30	143	104	4/24	F01	
H	F020T690HA80	100	3	740	740	--	--	90	72	3/22	F08	
A	F020T748ZA76	100	3/P/2	950	950	S24	S24	172	143		F01A	Silentbloc
	F020T748ZA75	100	3	950	950	S24	S24	172	84	3/26	F01	Silentbloc
H	F020T748HA80	100	2	765	765	--	--	145	48	2/21	F08	
A	F020T678ZA76	100	3/P/2	950	950	S24	S24	160	155		F01A	Silentbloc
	F020T678ZA75	100	3	950	950	S24	S24	160	87	3/27	F01	Silentbloc
H	F020T678HA80	100	2	760	760	--	--	85	54	2/25	F08	
A	F020T298ZA76	100	3/P/2	950	950	30	30	160	160		F01A	
	F020T298ZA75	100	3	950	950	30	30	160	90	3/27	F01	
H	F020T298HA80	100	2	760	760	--	--	80	56	2/25	F08	
A	F020T626ZA76	100	3/P/2	950	950	30	30	168	143		F01A	
	F020T626ZA75	100	3	950	950	30	30	168	87	3/26	F01	
H	F020T626HA80	100	2	765	765	--	--	108	48	2/21	F08	

BESTELNR N° COMMANDE ORDER NR BESTELNR	BR LRG WID BR	BLADEN LAMES LEAVES BLATT.	B	C	D1	D2	PH FL FA SP	PAK EP TH PAK	DETAIL	MOD	OPMERKINGEN REMARKS REMARKS BEMERKUNGEN
---	------------------------	-------------------------------------	---	---	----	----	----------------------	------------------------	--------	-----	--

SERIE : -**1834****voor-avant-front-Vorne**

A020T511ZA75	80	11	860	860	S22	S22	118	149	11/13.5	A01	
A020T677ZA75	80	14	860	860	S22	S22	176	147	14/10.5	A01	Silentbloc
A020T311ZB75	90	9	900	900	25	25	135	117	9/13	A01	
A020T333ZA75	90	10	900	900	25	25	80	145	5/15+5/14	A01	
A020T607ZA75	90	10	900	900	S24	S24	75	145	5/15+5/14	A01	Silentbloc
A020T615ZA75	90	13	900	900	S24	S24	120	158	2/13+11/12	A01	Silentbloc
A020T485ZA75	90	14	900	900	25	25	65	198	2/15+12/14	A01	
A020T623ZA75	90	14	900	900	S24	S24	70	198	2/15+12/14	A01	Silentbloc
A020T243ZB75	90	10	900	900	25	25	80	145	5/15+5/14	A01.16	Vervangen
F020T499ZA75	80	3	860	860	S22	S22	125	81	3/24	F01	
F020T515ZA75	80	4	860	860	S22	S22	128	100	4/22	F01	
F020T497ZA75	80	4	860	860	S22	S22	148	93	1/21+3/20	F01	
F020T583ZA75	80	4	860	860	S22	S22	143	98	1/20+3/22	F01	
F020T611ZA75	90	3	900	900	25	25	108	78	3/23.5	F01	
F020T303ZA75	90	3	900	900	25	25	163	72	3/21	F01	
F020T585ZA75	90	4	900	900	S24	S24	179	92	4/20	F01	
F020T591ZA75	90	4	900	900	S24	S24	150	96	4/21	F01	
F020T595ZA75	90	4	900	900	S24	S24	152	104	4/23	F01	
F020T655ZA75	90	4	900	900	S24	S24	128	100	4/22	F01	
F020T299ZA75	90	4	900	900	25	25	166	90	1/21+3/19	F01	
F020T369ZA75	90	4	900	900	25	25	150	96	4/21	F01	
F020T503ZA75	90	4	900	900	25	25	132	100	4/22	F01	
F020T513ZA75	90	2/P	750	650	S22	S22	-14	62	2/13+P/20	F01.70	Silentbloc

BESTELNR N° COMMANDE ORDER NR BESTELNR	BR LRG WID BR	BLADEN LAMES LEAVES BLATT.	B	C	D1	D2	PH FL FA SP	PAK EP TH PAK	DETAIL	MOD	OPMERKINGEN REMARKS REMARKS BEMERKUNGEN
---	------------------------	-------------------------------------	---	---	----	----	----------------------	------------------------	--------	-----	--

SERIE : -**1834****achter-arrière-rear-Hinten**

A	A020T652ZA76	80	7/P/7	950	950	S22	S22	177	244		A01A	Silentbloc
H	A020T652ZA75	80	7	950	950	S22	S22	177	112	7/16	A01	Silentbloc
H	A020T652HA80	80	7	775	775	--	--	43	112	7/16	A08	
A	A020T654ZA76	80	9/7	950	950	S22	S22	126	272		A01A	Silentbloc
H	A020T654ZA75	80	9	950	950	S22	S22	125	153	9/17	A01	Silentbloc
H	A020T654HA80	80	7	750	750	--	--	0	119	7/17	A08	
A	A020T270ZC76	100	8/P/6	900	900	30	30	195	212		A01A	
H	A020T270ZC75	100	8	900	900	30	30	195	115	3/15+5/14	A01	
H	A020T270HC80	100	6	750	750	--	--	90	84	6/14	A08	
A	A020T740ZA76	100	8/P/6	900	900	S24	S24	195	212		A01A	Silentbloc
H	A020T740ZA75	100	8	900	900	S24	S24		115	3/15+5/14	A01	Silentbloc
H	A020T740HA80	100	6	750	750			90	84	6/14	A08	
A	A020T310ZC76	100	9/P/7	900	900	30	30	170	242		A01A	
H	A020T310ZC75	100	9	900	900	30	30	170	130	4/15+5/14	A01	
H	A020T310HC80	100	7	770	770	--	--	70	98	7/14	A08	
A	A020T684ZA76	100	9/P/7	900	900	S24	S24	170	242		A01A	Silentbloc
H	A020T684ZA75	100	9	900	900	S24	S24	170	130	4/15+5/14	A01	Silentbloc
H	A020T684HA80	100	7	745	745	--	--	80	98	7/14	A08	
A	A020T310ZB76	100	9/P/7	900	900	30	30	170	242		A01A.17	
H	A020T310ZB75	100	9	900	900	30	30	170	130	4/15+5/14	A01.17	
H	A020T310HB80	100	7	770	770	--	--	70	98	7/14	A08	
A	F020T586ZA76	80	4/4	950	725	S22	S22	140	214		F01A	Silentbloc
H	F020T586ZA75	80	4	950	725	S22	S22	140	118	4/24	F01	Silentbloc
H	F020T586HA80	80	4	770	550	--	--	45	96	4/21	F08	
A	F020T584ZA76	80	2/2	950	950	S22	S22	125	122	2/32+2/25	F01A	Silentbloc
H	F020T584ZA75	80	2	950	950	S22	S22	125	68	2/32	F01	Silentbloc
H	F020T584HA80	80	2	760	760	--	--	70	54	2/25	F08	
A	F020T572ZA76	80	2/3	950	950	S22	S22	125	145		F01A	Silentbloc
H	F020T572ZA75	80	2	950	950	S22	S22	125	70	2/32	F01	Silentbloc
H	F020T572HA80	80	3	775	775	--	--	73	75	3/22	F08	
A	F020T570ZA76	80	3/3	950	950	S22	S22	180	171		F01A	Silentbloc
H	F020T570ZA75	80	3	950	950	S22	S22	180	87	3/26	F01	Silentbloc
H	F020T570HA80	80	3	760	760	--	--	70	84	3/25	F08	
A	F020T634ZA76	80	4/3	950	950	S22	S22	150	199		F01A	Silentbloc
H	F020T634ZA75	80	4	950	950	S22	S22	150	109	1/22+3/25	F01	Silentbloc
H	F020T634HA80	80	3	760	760	--	--	40	90	3/27	F08	
A	F020T752ZA76	100	3/P/2	900	900	S24	S24		0		F01A	Silentbloc
H	F020T752ZA75	100	3	900	900	S24	S24		0		F01	Silentbloc
H	F020T752HA80	100	2	0	0	--	--		0		F08	
A	F020T628ZA76	100	3/P/2	900	900	30	30	169	124		F01A	
H	F020T628ZA75	100	3	900	900	30	30	169	81	3/24	F01	
H	F020T628HA80	100	2	740	740	--	--	115	48	2/21	F08	

BESTELNR N° COMMANDE ORDER NR BESTELNR	BR LRG WID BR	BLADEN LAMES LEAVES BLATT.	B	C	D1	D2	PH FL FA SP	PAK EP TH PAK	DETAIL	MOD	OPMERKINGEN REMARQUES REMARKS BEMERKUNGEN
---	------------------------	-------------------------------------	---	---	----	----	----------------------	------------------------	--------	-----	--

SERIE : -

1834

A	F020T630ZA76	100	3/P/2	900	900	30	30	141	143		F01A	
	F020T630ZA75	100	3	900	900	30	30	141	87	3/27	F01	
H	F020T630HA80	100	2	740	740	--	--	73	58	2/26	F08	
A	F020T746ZA76	100	3/P/P/2	900	900	S24	S24	195	213		F01A	Silentbloc
	F020T746ZA75	100	3	900	900	S24	S24	195	81	2/25	F01	Silentbloc
H	F020T746HA80	100	2	740	740	--	--	129	52	2/24	F08	
A	F020T750ZA76	100	3/P/2	900	900	S24	S24	169	138	3/24+2/21	F01A	Silentbloc
	F020T750ZA75	100	3	900	900	S24	S24	169	78	3/24	F01	Silentbloc
H	F020T750HA80	100	2	740	740	--	--	130	46	2/21	F08	
A	F020T296ZA76	100	3/P/P/2	900	900	30	30	200	218		F01A	
	F020T296ZA75	100	3	900	900	30	30	200	84	3/25	F01	
H	F020T296HA80	100	2	740	740	--	--	110	54	2/24	F08	
A	F020T724ZA76	100	3/P/3	900	900	S24	S24	145	173		F01A	Silentbloc
	F020T724ZA75	100	3	900	900	S24	S24	145	81	3/25	F01	Silentbloc
H	F020T724HA80	100	3	740	740	--	--	96	78	3/24	F08	
A	F020T456ZA76	100	3/P/3	900	900	30	30	146	179		F01A	
	F020T456ZA75	100	3	900	900	30	30	146	84	3/25	F01	
H	F020T456HA80	100	3	740	740	--	--	90	81	3/24	F08	
A	F020T690ZA76	100	4/P/P/3	900	900	30	30	143	219		F01A	
	F020T690ZA75	100	4	900	900	30	30	143	104	4/24	F01	
H	F020T690HA80	100	3	740	740	--	--	90	72	3/22	F08	
A	F020T682ZA76	100	4/P/P/3	900	900	S24	S24	147	220		F01A	Silentbloc
	F020T682ZA75	100	4	900	900	S24	S24	147	104	4/24	F01	Silentbloc
H	F020T682HA80	100	3	740	740	--	--	85	72	3/22	F08	
A	F020T678ZA76	100	3/P/2	950	950	S24	S24	160	155		F01A	Silentbloc
	F020T678ZA75	100	3	950	950	S24	S24	160	87	3/27	F01	Silentbloc
H	F020T678HA80	100	2	760	760	--	--	85	54	2/25	F08	
A	F020T626ZA76	100	3/P/2	950	950	30	30	168	143		F01A	
	F020T626ZA75	100	3	950	950	30	30	168	87	3/26	F01	
H	F020T626HA80	100	2	765	765	--	--	108	48	2/21	F08	
A	F020T298ZA76	100	3/P/2	950	950	30	30	160	160		F01A	
	F020T298ZA75	100	3	950	950	30	30	160	90	3/27	F01	
H	F020T298HA80	100	2	760	760	--	--	80	56	2/25	F08	
A	F020T748ZA76	100	3/P/2	950	950	S24	S24	172	143		F01A	Silentbloc
	F020T748ZA75	100	3	950	950	S24	S24	172	84	3/26	F01	Silentbloc
H	F020T748HA80	100	2	765	765	--	--	145	48	2/21	F08	

BESTELNR N° COMMANDE ORDER NR BESTELNR	BR LRG WID BR	BLADEN LAMES LEAVES BLATT.	B	C	D1	D2	PH FL FA SP	PAK EP TH PAK	DETAIL	MOD	OPMERKINGEN REMARQUES REMARKS BEMERKUNGEN
---	------------------------	-------------------------------------	---	---	----	----	----------------------	------------------------	--------	-----	--

SERIE : -**1838****voor-avant-front-Vorne**

A020T311ZB75	90	9	900	900	25	25	135	117	9/13	A01	
A020T333ZA75	90	10	900	900	25	25	80	145	5/15+5/14	A01	
A020T607ZA75	90	10	900	900	S24	S24	75	145	5/15+5/14	A01	Silentbloc
A020T615ZA75	90	13	900	900	S24	S24	120	158	2/13+11/12	A01	Silentbloc
A020T243ZB75	90	10	900	900	25	25	80	145	5/15+5/14	A01.16	Vervangen
F020T611ZA75	90	3	900	900	25	25	108	78	3/23.5	F01	
F020T303ZA75	90	3	900	900	25	25	163	72	3/21	F01	
F020T503ZA75	90	4	900	900	25	25	132	100	4/22	F01	
F020T655ZA75	90	4	900	900	S24	S24	128	100	4/22	F01	
F020T595ZA75	90	4	900	900	S24	S24	152	104	4/23	F01	
F020T585ZA75	90	4	900	900	S24	S24	179	92	4/20	F01	
F020T369ZA75	90	4	900	900	25	25	150	96	4/21	F01	
F020T299ZA75	90	4	900	900	25	25	166	90	1/21+3/19	F01	
F020T591ZA75	90	4	900	900	S24	S24	150	96	4/21	F01	
F020T617ZA75	90	2	750	570	30	30	24	35	2/13	F01.70	
F020T597ZA75	90	2	800	840	S24	S24	-55	51	2/17+P/14	F01.70	Silentbloc

BESTELNR N° COMMANDE ORDER NR BESTELNR	BR LRG WID BR	BLADEN LAMES LEAVES BLATT.	B	C	D1	D2	PH FL FA SP	PAK EP TH PAK	DETAIL	MOD	OPMERKINGEN REMARKS BEMERKUNGEN
---	------------------------	-------------------------------------	---	---	----	----	----------------------	------------------------	--------	-----	---------------------------------------

SERIE : -

1838

achter-arrière-rear-Hinten

A	A020T740ZA76	100	8/P/6	900	900	S24	S24	195	212		A01A	Silentbloc
H	A020T740ZA75	100	8	900	900	S24	S24		115	3/15+5/14	A01	Silentbloc
H	A020T740HA80	100	6	750	750			90	84	6/14	A08	
A	A020T270ZC76	100	8/P/6	900	900	30	30	195	212		A01A	
H	A020T270ZC75	100	8	900	900	30	30	195	115	3/15+5/14	A01	
H	A020T270HC80	100	6	750	750	--	--	90	84	6/14	A08	
A	A020T310ZC76	100	9/P/7	900	900	30	30	170	242		A01A	
H	A020T310ZC75	100	9	900	900	30	30	170	130	4/15+5/14	A01	
H	A020T310HC80	100	7	770	770	--	--	70	98	7/14	A08	
A	A020T684ZA76	100	9/P/7	900	900	S24	S24	170	242		A01A	Silentbloc
H	A020T684ZA75	100	9	900	900	S24	S24	170	130	4/15+5/14	A01	Silentbloc
H	A020T684HA80	100	7	745	745	--	--	80	98	7/14	A08	
A	A020T310ZB76	100	9/P/7	900	900	30	30	170	242		A01A.17	
H	A020T310ZB75	100	9	900	900	30	30	170	130	4/15+5/14	A01.17	
H	A020T310HB80	100	7	770	770	--	--	70	98	7/14	A08	
A	F020T628ZA76	100	3/P/2	900	900	30	30	169	124		F01A	
H	F020T628ZA75	100	3	900	900	30	30	169	81	3/24	F01	
H	F020T628HA80	100	2	740	740	--	--	115	48	2/21	F08	
A	F020T296ZA76	100	3/P/P/2	900	900	30	30	200	218		F01A	
H	F020T296ZA75	100	3	900	900	30	30	200	84	3/25	F01	
H	F020T296HA80	100	2	740	740	--	--	110	54	2/24	F08	
A	F020T630ZA76	100	3/P/2	900	900	30	30	141	143		F01A	
H	F020T630ZA75	100	3	900	900	30	30	141	87	3/27	F01	
H	F020T630HA80	100	2	740	740	--	--	73	58	2/26	F08	
A	F020T750ZA76	100	3/P/2	900	900	S24	S24	169	138	3/24+2/21	F01A	Silentbloc
H	F020T750ZA75	100	3	900	900	S24	S24	169	78	3/24	F01	Silentbloc
H	F020T750HA80	100	2	740	740	--	--	130	46	2/21	F08	
A	F020T746ZA76	100	3/P/P/2	900	900	S24	S24	195	213		F01A	Silentbloc
H	F020T746ZA75	100	3	900	900	S24	S24	195	81	2/25	F01	Silentbloc
H	F020T746HA80	100	2	740	740	--	--	129	52	2/24	F08	
A	F020T752ZA76	100	3/P/2	900	900	S24	S24		0		F01A	Silentbloc
H	F020T752ZA75	100	3	900	900	S24	S24		0		F01	Silentbloc
H	F020T752HA80	100	2	0	0	--	--		0		F08	
A	F020T690ZA76	100	4/P/P/3	900	900	30	30	143	219		F01A	
H	F020T690ZA75	100	4	900	900	30	30	143	104	4/24	F01	
H	F020T690HA80	100	3	740	740	--	--	90	72	3/22	F08	
A	F020T682ZA76	100	4/P/P/3	900	900	S24	S24	147	220		F01A	Silentbloc
H	F020T682ZA75	100	4	900	900	S24	S24	147	104	4/24	F01	Silentbloc
H	F020T682HA80	100	3	740	740	--	--	85	72	3/22	F08	
A	F020T626ZA76	100	3/P/2	950	950	30	30	168	143		F01A	
H	F020T626ZA75	100	3	950	950	30	30	168	87	3/26	F01	
H	F020T626HA80	100	2	765	765	--	--	108	48	2/21	F08	

BESTELNR N° COMMANDE ORDER NR BESTELNR	BR LRG WID BR	BLADEN LAMES LEAVES BLATT.	B	C	D1	D2	PH FL FA SP	PAK EP TH PAK	DETAIL	MOD	OPMERKINGEN REMARQUES REMARKS BEMERKUNGEN
---	------------------------	-------------------------------------	---	---	----	----	----------------------	------------------------	--------	-----	--

SERIE : -

1838

A	F020T748ZA76	100	3/P/2	950	950	S24	S24	172	143		F01A	Silentbloc
H	F020T748ZA75	100	3	950	950	S24	S24	172	84	3/26	F01	Silentbloc
H	F020T748HA80	100	2	765	765	--	--	145	48	2/21	F08	
A	F020T678ZA76	100	3/P/2	950	950	S24	S24	160	155		F01A	Silentbloc
H	F020T678ZA75	100	3	950	950	S24	S24	160	87	3/27	F01	Silentbloc
H	F020T678HA80	100	2	760	760	--	--	85	54	2/25	F08	
A	F020T298ZA76	100	3/P/2	950	950	30	30	160	160		F01A	
H	F020T298ZA75	100	3	950	950	30	30	160	90	3/27	F01	
H	F020T298HA80	100	2	760	760	--	--	80	56	2/25	F08	

1840

voor-avant-front-Vorne

	F020T611ZA75	90	3	900	900	25	25	108	78	3/23.5	F01	
	F020T299ZA75	90	4	900	900	25	25	166	90	1/21+3/19	F01	
	F020T503ZA75	90	4	900	900	25	25	132	100	4/22	F01	
	F020T369ZA75	90	4	900	900	25	25	150	96	4/21	F01	

achter-arrière-rear-Hinten

A	F020T630ZA76	100	3/P/2	900	900	30	30	141	143		F01A	
H	F020T630ZA75	100	3	900	900	30	30	141	87	3/27	F01	
H	F020T630HA80	100	2	740	740	--	--	73	58	2/26	F08	
A	F020T296ZA76	100	3/P/P/2	900	900	30	30	200	218		F01A	
H	F020T296ZA75	100	3	900	900	30	30	200	84	3/25	F01	
H	F020T296HA80	100	2	740	740	--	--	110	54	2/24	F08	
A	F020T628ZA76	100	3/P/2	900	900	30	30	169	124		F01A	
H	F020T628ZA75	100	3	900	900	30	30	169	81	3/24	F01	
H	F020T628HA80	100	2	740	740	--	--	115	48	2/21	F08	
A	F020T690ZA76	100	4/P/P/3	900	900	30	30	143	219		F01A	
H	F020T690ZA75	100	4	900	900	30	30	143	104	4/24	F01	
H	F020T690HA80	100	3	740	740	--	--	90	72	3/22	F08	

BESTELNR N° COMMANDE ORDER NR BESTELNR	BR LRG WID BR	BLADEN LAMES LEAVES BLATT.	B	C	D1	D2	PH FL FA SP	PAK EP TH PAK	DETAIL	MOD	OPMERKINGEN REMARQUES REMARKS BEMERKUNGEN
---	------------------------	-------------------------------------	---	---	----	----	----------------------	------------------------	--------	-----	--

SERIE : -

1844

voor-avant-front-Vorne

A020T311ZB75	90	9	900	900	25	25	135	117	9/13	A01	
A020T607ZA75	90	10	900	900	S24	S24	75	145	5/15+5/14	A01	Silentbloc
A020T333ZA75	90	10	900	900	25	25	80	145	5/15+5/14	A01	
A020T615ZA75	90	13	900	900	S24	S24	120	158	2/13+11/12	A01	Silentbloc
A020T623ZA75	90	14	900	900	S24	S24	70	198	2/15+12/14	A01	Silentbloc
A020T243ZB75	90	10	900	900	25	25	80	145	5/15+5/14	A01.16	Vervangen
F020T303ZA75	90	3	900	900	25	25	163	72	3/21	F01	
F020T611ZA75	90	3	900	900	25	25	108	78	3/23.5	F01	
F020T591ZA75	90	4	900	900	S24	S24	150	96	4/21	F01	
F020T655ZA75	90	4	900	900	S24	S24	128	100	4/22	F01	
F020T299ZA75	90	4	900	900	25	25	166	90	1/21+3/19	F01	
F020T595ZA75	90	4	900	900	S24	S24	152	104	4/23	F01	
F020T585ZA75	90	4	900	900	S24	S24	179	92	4/20	F01	
F020T503ZA75	90	4	900	900	25	25	132	100	4/22	F01	
F020T369ZA75	90	4	900	900	25	25	150	96	4/21	F01	
F020T597ZA75	90	2	800	840	S24	S24	-55	51	2/17+P/14	F01.70	Silentbloc

BESTELNR N° COMMANDE ORDER NR BESTELNR	BR LRG WID BR	BLADEN LAMES LEAVES BLATT.	B	C	D1	D2	PH FL FA SP	PAK EP TH PAK	DETAIL	MOD	OPMERKINGEN REMARQUES REMARKS BEMERKUNGEN
---	------------------------	-------------------------------------	---	---	----	----	----------------------	------------------------	--------	-----	--

SERIE : -**1844****achter-arrière-rear-Hinten**

A	A020T740ZA76	100	8/P/6	900	900	S24	S24	195	212		A01A	Silentbloc
H	A020T740ZA75	100	8	900	900	S24	S24		115	3/15+5/14	A01	Silentbloc
H	A020T740HA80	100	6	750	750			90	84	6/14	A08	
A	A020T270ZC76	100	8/P/6	900	900	30	30	195	212		A01A	
H	A020T270ZC75	100	8	900	900	30	30	195	115	3/15+5/14	A01	
H	A020T270HC80	100	6	750	750	--	--	90	84	6/14	A08	
A	A020T684ZA76	100	9/P/7	900	900	S24	S24	170	242		A01A	Silentbloc
H	A020T684ZA75	100	9	900	900	S24	S24	170	130	4/15+5/14	A01	Silentbloc
H	A020T684HA80	100	7	745	745	--	--	80	98	7/14	A08	
A	A020T310ZC76	100	9/P/7	900	900	30	30	170	242		A01A	
H	A020T310ZC75	100	9	900	900	30	30	170	130	4/15+5/14	A01	
H	A020T310HC80	100	7	770	770	--	--	70	98	7/14	A08	
A	A020T310ZB76	100	9/P/7	900	900	30	30	170	242		A01A.17	
H	A020T310ZB75	100	9	900	900	30	30	170	130	4/15+5/14	A01.17	
H	A020T310HB80	100	7	770	770	--	--	70	98	7/14	A08	
A	F020T630ZA76	100	3/P/2	900	900	30	30	141	143		F01A	
H	F020T630ZA75	100	3	900	900	30	30	141	87	3/27	F01	
H	F020T630HA80	100	2	740	740	--	--	73	58	2/26	F08	
A	F020T628ZA76	100	3/P/2	900	900	30	30	169	124		F01A	
H	F020T628ZA75	100	3	900	900	30	30	169	81	3/24	F01	
H	F020T628HA80	100	2	740	740	--	--	115	48	2/21	F08	
A	F020T750ZA76	100	3/P/2	900	900	S24	S24	169	138	3/24+2/21	F01A	Silentbloc
H	F020T750ZA75	100	3	900	900	S24	S24	169	78	3/24	F01	Silentbloc
H	F020T750HA80	100	2	740	740	--	--	130	46	2/21	F08	
A	F020T746ZA76	100	3/P/P/2	900	900	S24	S24	195	213		F01A	Silentbloc
H	F020T746ZA75	100	3	900	900	S24	S24	195	81	2/25	F01	Silentbloc
H	F020T746HA80	100	2	740	740	--	--	129	52	2/24	F08	
A	F020T752ZA76	100	3/P/2	900	900	S24	S24		0		F01A	Silentbloc
H	F020T752ZA75	100	3	900	900	S24	S24		0		F01	Silentbloc
H	F020T752HA80	100	2	0	0	--	--		0		F08	
A	F020T296ZA76	100	3/P/P/2	900	900	30	30	200	218		F01A	
H	F020T296ZA75	100	3	900	900	30	30	200	84	3/25	F01	
H	F020T296HA80	100	2	740	740	--	--	110	54	2/24	F08	
A	F020T690ZA76	100	4/P/P/3	900	900	30	30	143	219		F01A	
H	F020T690ZA75	100	4	900	900	30	30	143	104	4/24	F01	
H	F020T690HA80	100	3	740	740	--	--	90	72	3/22	F08	
A	F020T682ZA76	100	4/P/P/3	900	900	S24	S24	147	220		F01A	Silentbloc
H	F020T682ZA75	100	4	900	900	S24	S24	147	104	4/24	F01	Silentbloc
H	F020T682HA80	100	3	740	740	--	--	85	72	3/22	F08	
A	F020T748ZA76	100	3/P/2	950	950	S24	S24	172	143		F01A	Silentbloc
H	F020T748ZA75	100	3	950	950	S24	S24	172	84	3/26	F01	Silentbloc
H	F020T748HA80	100	2	765	765	--	--	145	48	2/21	F08	

BESTELNR N° COMMANDE ORDER NR BESTELLNR	BR LRG WID BR	BLADEN LAMES LEAVES BLATT.	B	C	D1	D2	PH FL FA SP	PAK EP TH PAK	DETAIL	MOD	OPMERKINGEN REMARQUES REMARKS BEMERKUNGEN
--	------------------------	-------------------------------------	---	---	----	----	----------------------	------------------------	--------	-----	--

SERIE : -

1844

	F020T626ZA76	100	3/P/2	950	950	30	30	168	143		F01A	
A	F020T626ZA75	100	3	950	950	30	30	168	87	3/26	F01	
H	F020T626HA80	100	2	765	765	--	--	108	48	2/21	F08	
	F020T298ZA76	100	3/P/2	950	950	30	30	160	160		F01A	
A	F020T298ZA75	100	3	950	950	30	30	160	90	3/27	F01	
H	F020T298HA80	100	2	760	760	--	--	80	56	2/25	F08	
	F020T678ZA76	100	3/P/2	950	950	S24	S24	160	155		F01A	Silentbloc
A	F020T678ZA75	100	3	950	950	S24	S24	160	87	3/27	F01	Silentbloc
H	F020T678HA80	100	2	760	760	--	--	85	54	2/25	F08	

BESTELNR N° COMMANDE ORDER NR BESTELLNR	BR LRG WID BR	BLADEN LAMES LEAVES BLATT.	B	C	D1	D2	PH FL FA SP	PAK EP TH PAK	DETAIL	MOD	OPMERKINGEN REMARQUES REMARKS BEMERKUNGEN
--	------------------------	-------------------------------------	---	---	----	----	----------------------	------------------------	--------	-----	--

SERIE : -**1850****voor-avant-front-Vorne**

A020T239ZB75	90	13	900	900	25	25	130	156	13/12	A01
F020T303ZA75	90	3	900	900	25	25	163	72	3/21	F01
F020T611ZA75	90	3	900	900	25	25	108	78	3/23.5	F01
F020T595ZA75	90	4	900	900	S24	S24	152	104	4/23	F01
F020T585ZA75	90	4	900	900	S24	S24	179	92	4/20	F01
F020T369ZA75	90	4	900	900	25	25	150	96	4/21	F01
F020T503ZA75	90	4	900	900	25	25	132	100	4/22	F01
F020T655ZA75	90	4	900	900	S24	S24	128	100	4/22	F01
F020T299ZA75	90	4	900	900	25	25	166	90	1/21+3/19	F01
F020T591ZA75	90	4	900	900	S24	S24	150	96	4/21	F01

BESTELNR N° COMMANDE ORDER NR BESTELNR	BR LRG WID BR	BLADEN LAMES LEAVES BLATT.	B	C	D1	D2	PH FL FA SP	PAK EP TH PAK	DETAIL	MOD	OPMERKINGEN REMARQUES REMARKS BEMERKUNGEN
---	------------------------	-------------------------------------	---	---	----	----	----------------------	------------------------	--------	-----	--

SERIE : -**1850****achter-arrière-rear-Hinten**

A	F020T752ZA76	100	3/P/2	900	900	S24	S24		0		F01A	Silentbloc
	F020T752ZA75	100	3	900	900	S24	S24		0		F01	Silentbloc
H	F020T752HA80	100	2	0	0	--	--		0		F08	
A	F020T750ZA76	100	3/P/2	900	900	S24	S24	169	138	3/24+2/21	F01A	Silentbloc
	F020T750ZA75	100	3	900	900	S24	S24	169	78	3/24	F01	Silentbloc
H	F020T750HA80	100	2	740	740	--	--	130	46	2/21	F08	
A	F020T746ZA76	100	3/P/P/2	900	900	S24	S24	195	213		F01A	Silentbloc
	F020T746ZA75	100	3	900	900	S24	S24	195	81	2/25	F01	Silentbloc
H	F020T746HA80	100	2	740	740	--	--	129	52	2/24	F08	
A	F020T630ZA76	100	3/P/2	900	900	30	30	141	143		F01A	
	F020T630ZA75	100	3	900	900	30	30	141	87	3/27	F01	
H	F020T630HA80	100	2	740	740	--	--	73	58	2/26	F08	
A	F020T628ZA76	100	3/P/2	900	900	30	30	169	124		F01A	
	F020T628ZA75	100	3	900	900	30	30	169	81	3/24	F01	
H	F020T628HA80	100	2	740	740	--	--	115	48	2/21	F08	
A	F020T296ZA76	100	3/P/P/2	900	900	30	30	200	218		F01A	
	F020T296ZA75	100	3	900	900	30	30	200	84	3/25	F01	
H	F020T296HA80	100	2	740	740	--	--	110	54	2/24	F08	
A	F020T690ZA76	100	4/P/P/3	900	900	30	30	143	219		F01A	
	F020T690ZA75	100	4	900	900	30	30	143	104	4/24	F01	
H	F020T690HA80	100	3	740	740	--	--	90	72	3/22	F08	
A	F020T682ZA76	100	4/P/P/3	900	900	S24	S24	147	220		F01A	Silentbloc
	F020T682ZA75	100	4	900	900	S24	S24	147	104	4/24	F01	Silentbloc
H	F020T682HA80	100	3	740	740	--	--	85	72	3/22	F08	
A	F020T748ZA76	100	3/P/2	950	950	S24	S24	172	143		F01A	Silentbloc
	F020T748ZA75	100	3	950	950	S24	S24	172	84	3/26	F01	Silentbloc
H	F020T748HA80	100	2	765	765	--	--	145	48	2/21	F08	
A	F020T678ZA76	100	3/P/2	950	950	S24	S24	160	155		F01A	Silentbloc
	F020T678ZA75	100	3	950	950	S24	S24	160	87	3/27	F01	Silentbloc
H	F020T678HA80	100	2	760	760	--	--	85	54	2/25	F08	
A	F020T298ZA76	100	3/P/2	950	950	30	30	160	160		F01A	
	F020T298ZA75	100	3	950	950	30	30	160	90	3/27	F01	
H	F020T298HA80	100	2	760	760	--	--	80	56	2/25	F08	
A	F020T626ZA76	100	3/P/2	950	950	30	30	168	143		F01A	
	F020T626ZA75	100	3	950	950	30	30	168	87	3/26	F01	
H	F020T626HA80	100	2	765	765	--	--	108	48	2/21	F08	

BESTELNR N° COMMANDE ORDER NR BESTELLNR	BR LRG WID BR	BLADEN LAMES LEAVES BLATT.	B	C	D1	D2	PH FL FA SP	PAK EP TH PAK	DETAIL	MOD	OPMERKINGEN REMARQUES REMARKS BEMERKUNGEN
--	------------------------	-------------------------------------	---	---	----	----	----------------------	------------------------	--------	-----	--

SERIE : -

1922

voor-avant-front-Vorne

A020T311ZB75	90	9	900	900	25	25	135	117	9/13	A01	
A020T333ZA75	90	10	900	900	25	25	80	145	5/15+5/14	A01	
A020T235ZB75	90	12	900	900	25	25	200	122	2/11+10/10	A01	
A020T323ZA75	90	12	900	900	25	25	90	175	7/15+5/14	A01	
A020T239ZB75	90	13	900	900	25	25	130	156	13/12	A01	
A020T485ZA75	90	14	900	900	25	25	65	198	2/15+12/14	A01	
A020T243ZB75	90	10	900	900	25	25	80	145	5/15+5/14	A01.16	Vervangen
A020T235ZA75	90	12	900	900	25	25	200	122	2/11+10/10	A01.16	Vervangen
F020T303ZA75	90	3	900	900	25	25	163	72	3/21	F01	
F020T503ZA75	90	4	900	900	25	25	132	100	4/22	F01	
F020T369ZA75	90	4	900	900	25	25	150	96	4/21	F01	
F020T299ZA75	90	4	900	900	25	25	166	90	1/21+3/19	F01	
F020T617ZA75	90	2	750	570	30	30	24	35	2/13	F01.70	
F020T567ZA75	90	2	750	570	30	30	-15	36	2/14	F01.70	

BESTELNR N° COMMANDE ORDER NR BESTELNR	BR LRG WID BR	BLADEN LAMES LEAVES BLATT.	B	C	D1	D2	PH FL FA SP	PAK EP TH PAK	DETAIL	MOD	OPMERKINGEN REMARQUES REMARKS BEMERKUNGEN
---	------------------------	-------------------------------------	---	---	----	----	----------------------	------------------------	--------	-----	--

SERIE : -

1922

achter-arrière-rear-Hinten

	A020T270ZC76	100	8/P/6	900	900	30	30	195	212		A01A	
A	A020T270ZC75	100	8	900	900	30	30	195	115	3/15+5/14	A01	
H	A020T270HC80	100	6	750	750	--	--	90	84	6/14	A08	
	A020T310ZC76	100	9/P/7	900	900	30	30	170	242		A01A	
A	A020T310ZC75	100	9	900	900	30	30	170	130	4/15+5/14	A01	
H	A020T310HC80	100	7	770	770	--	--	70	98	7/14	A08	
	A020T242ZC76	100	11/P/10	900	900	30	30	190	303		A01A	
A	A020T242ZC75	100	11	900	900	30	30	190	160	6/15+5/14	A01	
H	A020T242HC80	100	10	750	750	--	--	67	130	10/13	A08	
	A020T562ZA76	100	5/P/4	950	950	30	30	150	167		A01A	
A	A020T562ZA75	100	5	950	950	30	30	150	90	5/18	A01	
H	A020T562HA80	100	4	760	760	--	--	70	64	4/16	A08	
	A020T548ZA76	100	9/P/7	950	950	30	30	206	246		A01A	
A	A020T548ZA75	100	9	950	950	30	30	206	135	9/15	A01	
H	A020T548HA80	100	7	800	800	--	--	112	98	7/14	A08	
	A020T310ZB76	100	9/P/7	900	900	30	30	170	242		A01A.17	
A	A020T310ZB75	100	9	900	900	30	30	170	130	4/15+5/14	A01.17	
H	A020T310HB80	100	7	770	770	--	--	70	98	7/14	A08	
	A020T242ZB76	100	11/P/10	900	900	30	30	190	303		A01A.17	Vervangen
A	A020T242ZB75	100	11	900	900	30	30	190	160	5/15+1/14+1/15+4	A01.17	Vervangen
H	A020T242HB80	100	10	750	750	--	--	67	130	10/13	A08	
	A020T452ZA75	100	7/4	780	620	30	30	120	148	7/12+4/16	A01B	
	F020T508ZA75	100	6	620	780	30	30	85	144	6/22	F01	
	F020T296ZA76	100	3/P/P/2	900	900	30	30	200	218		F01A	
A	F020T296ZA75	100	3	900	900	30	30	200	84	3/25	F01	
H	F020T296HA80	100	2	740	740	--	--	110	54	2/24	F08	
	F020T456ZA76	100	3/P/3	900	900	30	30	146	179		F01A	
A	F020T456ZA75	100	3	900	900	30	30	146	84	3/25	F01	
H	F020T456HA80	100	3	740	740	--	--	90	81	3/24	F08	
	F020T690ZA76	100	4/P/P/3	900	900	30	30	143	219		F01A	
A	F020T690ZA75	100	4	900	900	30	30	143	104	4/24	F01	
H	F020T690HA80	100	3	740	740	--	--	90	72	3/22	F08	
	F020T298ZA76	100	3/P/2	950	950	30	30	160	160		F01A	
A	F020T298ZA75	100	3	950	950	30	30	160	90	3/27	F01	
H	F020T298HA80	100	2	760	760	--	--	80	56	2/25	F08	

BESTELNR N° COMMANDE ORDER NR BESTELNR	BR LRG WID BR	BLADEN LAMES LEAVES BLATT.	B	C	D1	D2	PH FL FA SP	PAK EP TH PAK	DETAIL	MOD	OPMERKINGEN REMARKS BEMERKUNGEN
---	------------------------	-------------------------------------	---	---	----	----	----------------------	------------------------	--------	-----	---------------------------------------

SERIE : -

1928

voor-avant-front-Vorne

A020T311ZB75	90	9	900	900	25	25	135	117	9/13	A01	
A020T333ZA75	90	10	900	900	25	25	80	145	5/15+5/14	A01	
A020T235ZB75	90	12	900	900	25	25	200	122	2/11+10/10	A01	
A020T323ZA75	90	12	900	900	25	25	90	175	7/15+5/14	A01	
A020T239ZB75	90	13	900	900	25	25	130	156	13/12	A01	
A020T485ZA75	90	14	900	900	25	25	65	198	2/15+12/14	A01	
A020T243ZB75	90	10	900	900	25	25	80	145	5/15+5/14	A01.16	Vervangen
A020T235ZA75	90	12	900	900	25	25	200	122	2/11+10/10	A01.16	Vervangen
F020T303ZA75	90	3	900	900	25	25	163	72	3/21	F01	
F020T503ZA75	90	4	900	900	25	25	132	100	4/22	F01	
F020T369ZA75	90	4	900	900	25	25	150	96	4/21	F01	
F020T299ZA75	90	4	900	900	25	25	166	90	1/21+3/19	F01	
F020T567ZA75	90	2	750	570	30	30	-15	36	2/14	F01.70	
F020T561ZA75	90	2/P	800	850	30	30	-70	50	1/16+1/18+P/13	F01.70	
F020T297ZA75	90	3	900	900	25	25	160	75	3/22	F01.70	

BESTELNR N° COMMANDE ORDER NR BESTELNR	BR LRG WID BR	BLADEN LAMES LEAVES BLATT.	B	C	D1	D2	PH FL FA SP	PAK EP TH PAK	DETAIL	MOD	OPMERKINGEN REMARKS REMARKS BEMERKUNGEN
---	------------------------	-------------------------------------	---	---	----	----	----------------------	------------------------	--------	-----	--

SERIE : -**1928****achter-arrière-rear-Hinten**

	A020T270ZC76	100	8/P/6	900	900	30	30	195	212		A01A
A	A020T270ZC75	100	8	900	900	30	30	195	115	3/15+5/14	A01
H	A020T270HC80	100	6	750	750	--	--	90	84	6/14	A08
	A020T310ZC76	100	9/P/7	900	900	30	30	170	242		A01A
A	A020T310ZC75	100	9	900	900	30	30	170	130	4/15+5/14	A01
H	A020T310HC80	100	7	770	770	--	--	70	98	7/14	A08
	A020T242ZC76	100	11/P/10	900	900	30	30	190	303		A01A
A	A020T242ZC75	100	11	900	900	30	30	190	160	6/15+5/14	A01
H	A020T242HC80	100	10	750	750	--	--	67	130	10/13	A08
	A020T562ZA76	100	5/P/4	950	950	30	30	150	167		A01A
A	A020T562ZA75	100	5	950	950	30	30	150	90	5/18	A01
H	A020T562HA80	100	4	760	760	--	--	70	64	4/16	A08
	A020T548ZA76	100	9/P/7	950	950	30	30	206	246		A01A
A	A020T548ZA75	100	9	950	950	30	30	206	135	9/15	A01
H	A020T548HA80	100	7	800	800	--	--	112	98	7/14	A08
	A020T310ZB76	100	9/P/7	900	900	30	30	170	242		A01A.17
A	A020T310ZB75	100	9	900	900	30	30	170	130	4/15+5/14	A01.17
H	A020T310HB80	100	7	770	770	--	--	70	98	7/14	A08
	A020T242ZB76	100	11/P/10	900	900	30	30	190	303		A01A.17
A	A020T242ZB75	100	11	900	900	30	30	190	160	5/15+1/14+1/15+4	A01.17
H	A020T242HB80	100	10	750	750	--	--	67	130	10/13	A08
	F020T296ZA76	100	3/P/P/2	900	900	30	30	200	218		F01A
A	F020T296ZA75	100	3	900	900	30	30	200	84	3/25	F01
H	F020T296HA80	100	2	740	740	--	--	110	54	2/24	F08
	F020T456ZA76	100	3/P/3	900	900	30	30	146	179		F01A
A	F020T456ZA75	100	3	900	900	30	30	146	84	3/25	F01
H	F020T456HA80	100	3	740	740	--	--	90	81	3/24	F08
	F020T298ZA76	100	3/P/2	950	950	30	30	160	160		F01A
A	F020T298ZA75	100	3	950	950	30	30	160	90	3/27	F01
H	F020T298HA80	100	2	760	760	--	--	80	56	2/25	F08

BESTELNR N° COMMANDE ORDER NR BESTELNR	BR LRG WID BR	BLADEN LAMES LEAVES BLATT.	B	C	D1	D2	PH FL FA SP	PAK EP TH PAK	DETAIL	MOD	OPMERKINGEN REMARKS BEMERKUNGEN
---	------------------------	-------------------------------------	---	---	----	----	----------------------	------------------------	--------	-----	---------------------------------------

SERIE : -**1929****voor-avant-front-Vorne**

A020T421ZA75	90	12	765	900	30	25	210	144	12/12	A01	
A020T589ZA75	90	12	900	765	25	25	78	144	12/12	A01	
A020T419ZA75	90	12	900	765	25	25	120	144	12/12	A01	
A020T311ZB75	90	9	900	900	25	25	135	117	9/13	A01	
A020T333ZA75	90	10	900	900	25	25	80	145	5/15+5/14	A01	
A020T239ZB75	90	13	900	900	25	25	130	156	13/12	A01	
A020T485ZA75	90	14	900	900	25	25	65	198	2/15+12/14	A01	
A020T243ZB75	90	10	900	900	25	25	80	145	5/15+5/14	A01.16	Vervangen
F020T605ZA75	90	5	765	900	30	25	215	115	5/20	F01	
F020T601ZA75	90	5	900	765	25	25	123	115	5/20	F01	
F020T611ZA75	90	3	900	900	25	25	108	78	3/23.5	F01	
F020T303ZA75	90	3	900	900	25	25	163	72	3/21	F01	
F020T369ZA75	90	4	900	900	25	25	150	96	4/21	F01	
F020T503ZA75	90	4	900	900	25	25	132	100	4/22	F01	
F020T299ZA75	90	4	900	900	25	25	166	90	1/21+3/19	F01	
F020T567ZA75	90	2	750	570	30	30	-15	36	2/14	F01.70	
F020T561ZA75	90	2/P	800	850	30	30	-70	50	1/16+1/18+P/13	F01.70	
F020T603ZA75	90	2/P	800	850	30	30	-40	51	2/17+P/14	F01.70	

BESTELNR N° COMMANDE ORDER NR BESTELNR	BR LRG WID BR	BLADEN LAMES LEAVES BLATT.	B	C	D1	D2	PH FL FA SP	PAK EP TH PAK	DETAIL	MOD	OPMERKINGEN REMARKS REMARKS BEMERKUNGEN
---	------------------------	-------------------------------------	---	---	----	----	----------------------	------------------------	--------	-----	--

SERIE : -

1929

achter-arrière-rear-Hinten

	A020T270ZC76	100	8/P/6	900	900	30	30	195	212		A01A	
A	A020T270ZC75	100	8	900	900	30	30	195	115	3/15+5/14	A01	
H	A020T270HC80	100	6	750	750	--	--	90	84	6/14	A08	
	A020T310ZC76	100	9/P/7	900	900	30	30	170	242		A01A	
A	A020T310ZC75	100	9	900	900	30	30	170	130	4/15+5/14	A01	
H	A020T310HC80	100	7	770	770	--	--	70	98	7/14	A08	
	A020T242ZC76	100	11/P/10	900	900	30	30	190	303		A01A	
A	A020T242ZC75	100	11	900	900	30	30	190	160	6/15+5/14	A01	
H	A020T242HC80	100	10	750	750	--	--	67	130	10/13	A08	
	A020T548ZA76	100	9/P/7	950	950	30	30	206	246		A01A	
A	A020T548ZA75	100	9	950	950	30	30	206	135	9/15	A01	
H	A020T548HA80	100	7	800	800	--	--	112	98	7/14	A08	
	A020T310ZB76	100	9/P/7	900	900	30	30	170	242		A01A.17	
A	A020T310ZB75	100	9	900	900	30	30	170	130	4/15+5/14	A01.17	
H	A020T310HB80	100	7	770	770	--	--	70	98	7/14	A08	
	A020T242ZB76	100	11/P/10	900	900	30	30	190	303		A01A.17	Vervangen
A	A020T242ZB75	100	11	900	900	30	30	190	160	5/15+1/14+1/15+4	A01.17	Vervangen
H	A020T242HB80	100	10	750	750	--	--	67	130	10/13	A08	
	F020T296ZA76	100	3/P/P/2	900	900	30	30	200	218		F01A	
A	F020T296ZA75	100	3	900	900	30	30	200	84	3/25	F01	
H	F020T296HA80	100	2	740	740	--	--	110	54	2/24	F08	
	F020T456ZA76	100	3/P/3	900	900	30	30	146	179		F01A	
A	F020T456ZA75	100	3	900	900	30	30	146	84	3/25	F01	
H	F020T456HA80	100	3	740	740	--	--	90	81	3/24	F08	
	F020T690ZA76	100	4/P/P/3	900	900	30	30	143	219		F01A	
A	F020T690ZA75	100	4	900	900	30	30	143	104	4/24	F01	
H	F020T690HA80	100	3	740	740	--	--	90	72	3/22	F08	
	F020T298ZA76	100	3/P/2	950	950	30	30	160	160		F01A	
A	F020T298ZA75	100	3	950	950	30	30	160	90	3/27	F01	
H	F020T298HA80	100	2	760	760	--	--	80	56	2/25	F08	

BESTELNR N° COMMANDE ORDER NR BESTELNR	BR LRG WID BR	BLADEN LAMES LEAVES BLATT.	B	C	D1	D2	PH FL FA SP	PAK EP TH PAK	DETAIL	MOD	OPMERKINGEN REMARQUES REMARKS BEMERKUNGEN
---	------------------------	-------------------------------------	---	---	----	----	----------------------	------------------------	--------	-----	--

SERIE : -**1933****voor-avant-front-Vorne**

A020T421ZA75	90	12	765	900	30	25	210	144	12/12	A01	
A020T419ZA75	90	12	900	765	25	25	120	144	12/12	A01	
A020T235ZB75	90	12	900	900	25	25	200	122	2/11+10/10	A01	
A020T323ZA75	90	12	900	900	25	25	90	175	7/15+5/14	A01	
A020T239ZB75	90	13	900	900	25	25	130	156	13/12	A01	
A020T485ZA75	90	14	900	900	25	25	65	198	2/15+12/14	A01	
A020T235ZA75	90	12	900	900	25	25	200	122	2/11+10/10	A01.16	Vervangen
F020T605ZA75	90	5	765	900	30	25	215	115	5/20	F01	
F020T601ZA75	90	5	900	765	25	25	123	115	5/20	F01	
F020T303ZA75	90	3	900	900	25	25	163	72	3/21	F01	
F020T369ZA75	90	4	900	900	25	25	150	96	4/21	F01	
F020T299ZA75	90	4	900	900	25	25	166	90	1/21+3/19	F01	
F020T567ZA75	90	2	750	570	30	30	-15	36	2/14	F01.70	
F020T297ZA75	90	3	900	900	25	25	160	75	3/22	F01.70	

BESTELNR N° COMMANDE ORDER NR BESTELNR	BR LRG WID BR	BLADEN LAMES LEAVES BLATT.	B	C	D1	D2	PH FL FA SP	PAK EP TH PAK	DETAIL	MOD	OPMERKINGEN REMARKS REMARKS BEMERKUNGEN
---	------------------------	-------------------------------------	---	---	----	----	----------------------	------------------------	--------	-----	--

SERIE : -**1933****achter-arrière-rear-Hinten**

	A020T270ZC76	100	8/P/6	900	900	30	30	195	212		A01A	
A	A020T270ZC75	100	8	900	900	30	30	195	115	3/15+5/14	A01	
H	A020T270HC80	100	6	750	750	--	--	90	84	6/14	A08	
	A020T310ZC76	100	9/P/7	900	900	30	30	170	242		A01A	
A	A020T310ZC75	100	9	900	900	30	30	170	130	4/15+5/14	A01	
H	A020T310HC80	100	7	770	770	--	--	70	98	7/14	A08	
	A020T242ZC76	100	11/P/10	900	900	30	30	190	303		A01A	
A	A020T242ZC75	100	11	900	900	30	30	190	160	6/15+5/14	A01	
H	A020T242HC80	100	10	750	750	--	--	67	130	10/13	A08	
	A020T562ZA76	100	5/P/4	950	950	30	30	150	167		A01A	
A	A020T562ZA75	100	5	950	950	30	30	150	90	5/18	A01	
H	A020T562HA80	100	4	760	760	--	--	70	64	4/16	A08	
	A020T548ZA76	100	9/P/7	950	950	30	30	206	246		A01A	
A	A020T548ZA75	100	9	950	950	30	30	206	135	9/15	A01	
H	A020T548HA80	100	7	800	800	--	--	112	98	7/14	A08	
	A020T310ZB76	100	9/P/7	900	900	30	30	170	242		A01A.17	
A	A020T310ZB75	100	9	900	900	30	30	170	130	4/15+5/14	A01.17	
H	A020T310HB80	100	7	770	770	--	--	70	98	7/14	A08	
	A020T242ZB76	100	11/P/10	900	900	30	30	190	303		A01A.17	Vervangen
A	A020T242ZB75	100	11	900	900	30	30	190	160	5/15+1/14+1/15+4	A01.17	Vervangen
H	A020T242HB80	100	10	750	750	--	--	67	130	10/13	A08	
	F020T296ZA76	100	3/P/P/2	900	900	30	30	200	218		F01A	
A	F020T296ZA75	100	3	900	900	30	30	200	84	3/25	F01	
H	F020T296HA80	100	2	740	740	--	--	110	54	2/24	F08	
	F020T456ZA76	100	3/P/3	900	900	30	30	146	179		F01A	
A	F020T456ZA75	100	3	900	900	30	30	146	84	3/25	F01	
H	F020T456HA80	100	3	740	740	--	--	90	81	3/24	F08	
	F020T298ZA76	100	3/P/2	950	950	30	30	160	160		F01A	
A	F020T298ZA75	100	3	950	950	30	30	160	90	3/27	F01	
H	F020T298HA80	100	2	760	760	--	--	80	56	2/25	F08	

BESTELNR N° COMMANDE ORDER NR BESTELNR	BR LRG WID BR	BLADEN LAMES LEAVES BLATT.	B	C	D1	D2	PH FL FA SP	PAK EP TH PAK	DETAIL	MOD	OPMERKINGEN REMARKS REMARKS BEMERKUNGEN
---	------------------------	-------------------------------------	---	---	----	----	----------------------	------------------------	--------	-----	--

SERIE : -**1935****voor-avant-front-Vorne**

A020T311ZB75	90	9	900	900	25	25	135	117	9/13	A01	
A020T333ZA75	90	10	900	900	25	25	80	145	5/15+5/14	A01	
A020T235ZB75	90	12	900	900	25	25	200	122	2/11+10/10	A01	
A020T323ZA75	90	12	900	900	25	25	90	175	7/15+5/14	A01	
A020T239ZB75	90	13	900	900	25	25	130	156	13/12	A01	
A020T485ZA75	90	14	900	900	25	25	65	198	2/15+12/14	A01	
A020T243ZB75	90	10	900	900	25	25	80	145	5/15+5/14	A01.16	Vervangen
A020T235ZA75	90	12	900	900	25	25	200	122	2/11+10/10	A01.16	Vervangen
F020T605ZA75	90	5	765	900	30	25	215	115	5/20	F01	
F020T601ZA75	90	5	900	765	25	25	123	115	5/20	F01	
F020T611ZA75	90	3	900	900	25	25	108	78	3/23.5	F01	
F020T303ZA75	90	3	900	900	25	25	163	72	3/21	F01	
F020T503ZA75	90	4	900	900	25	25	132	100	4/22	F01	
F020T369ZA75	90	4	900	900	25	25	150	96	4/21	F01	
F020T299ZA75	90	4	900	900	25	25	166	90	1/21+3/19	F01	
F020T567ZA75	90	2	750	570	30	30	-15	36	2/14	F01.70	

BESTELNR N° COMMANDE ORDER NR BESTELNR	BR LRG WID BR	BLADEN LAMES LEAVES BLATT.	B	C	D1	D2	PH FL FA SP	PAK EP TH PAK	DETAIL	MOD	OPMERKINGEN REMARKS REMARKS BEMERKUNGEN
---	------------------------	-------------------------------------	---	---	----	----	----------------------	------------------------	--------	-----	--

SERIE : -

1935

achter-arrière-rear-Hinten

A	A020T270ZC76	100	8/P/6	900	900	30	30	195	212		A01A	
A	A020T270ZC75	100	8	900	900	30	30	195	115	3/15+5/14	A01	
H	A020T270HC80	100	6	750	750	--	--	90	84	6/14	A08	
A	A020T310ZC76	100	9/P/7	900	900	30	30	170	242		A01A	
A	A020T310ZC75	100	9	900	900	30	30	170	130	4/15+5/14	A01	
H	A020T310HC80	100	7	770	770	--	--	70	98	7/14	A08	
A	A020T242ZC76	100	11/P/10	900	900	30	30	190	303		A01A	
A	A020T242ZC75	100	11	900	900	30	30	190	160	6/15+5/14	A01	
H	A020T242HC80	100	10	750	750	--	--	67	130	10/13	A08	
A	A020T562ZA76	100	5/P/4	950	950	30	30	150	167		A01A	
A	A020T562ZA75	100	5	950	950	30	30	150	90	5/18	A01	
H	A020T562HA80	100	4	760	760	--	--	70	64	4/16	A08	
A	A020T548ZA76	100	9/P/7	950	950	30	30	206	246		A01A	
A	A020T548ZA75	100	9	950	950	30	30	206	135	9/15	A01	
H	A020T548HA80	100	7	800	800	--	--	112	98	7/14	A08	
A	A020T310ZB76	100	9/P/7	900	900	30	30	170	242		A01A.17	
A	A020T310ZB75	100	9	900	900	30	30	170	130	4/15+5/14	A01.17	
H	A020T310HB80	100	7	770	770	--	--	70	98	7/14	A08	
A	A020T242ZB76	100	11/P/10	900	900	30	30	190	303		A01A.17	Vervangen
A	A020T242ZB75	100	11	900	900	30	30	190	160	5/15+1/14+1/15+4	A01.17	Vervangen
H	A020T242HB80	100	10	750	750	--	--	67	130	10/13	A08	
A	A020T452ZA75	100	7/4	780	620	30	30	120	148	7/12+4/16	A01B	
A	F020T296ZA76	100	3/P/P/2	900	900	30	30	200	218		F01A	
A	F020T296ZA75	100	3	900	900	30	30	200	84	3/25	F01	
H	F020T296HA80	100	2	740	740	--	--	110	54	2/24	F08	
A	F020T456ZA76	100	3/P/3	900	900	30	30	146	179		F01A	
A	F020T456ZA75	100	3	900	900	30	30	146	84	3/25	F01	
H	F020T456HA80	100	3	740	740	--	--	90	81	3/24	F08	
A	F020T690ZA76	100	4/P/P/3	900	900	30	30	143	219		F01A	
A	F020T690ZA75	100	4	900	900	30	30	143	104	4/24	F01	
H	F020T690HA80	100	3	740	740	--	--	90	72	3/22	F08	
A	F020T298ZA76	100	3/P/2	950	950	30	30	160	160		F01A	
A	F020T298ZA75	100	3	950	950	30	30	160	90	3/27	F01	
H	F020T298HA80	100	2	760	760	--	--	80	56	2/25	F08	

BESTELNR N° COMMANDE ORDER NR BESTELLNR	BR LRG WID BR	BLADEN LAMES LEAVES BLATT.	B	C	D1	D2	PH FL FA SP	PAK EP TH PAK	DETAIL	MOD	OPMERKINGEN REMARQUES REMARKS BEMERKUNGEN
--	------------------------	-------------------------------------	---	---	----	----	----------------------	------------------------	--------	-----	--

SERIE : -

1936

voor-avant-front-Vorne

A020T311ZB75	90	9	900	900	25	25	135	117	9/13	A01	
A020T333ZA75	90	10	900	900	25	25	80	145	5/15+5/14	A01	
A020T235ZB75	90	12	900	900	25	25	200	122	2/11+10/10	A01	
A020T323ZA75	90	12	900	900	25	25	90	175	7/15+5/14	A01	
A020T239ZB75	90	13	900	900	25	25	130	156	13/12	A01	
A020T485ZA75	90	14	900	900	25	25	65	198	2/15+12/14	A01	
A020T243ZB75	90	10	900	900	25	25	80	145	5/15+5/14	A01.16	Vervangen
A020T235ZA75	90	12	900	900	25	25	200	122	2/11+10/10	A01.16	Vervangen
F020T303ZA75	90	3	900	900	25	25	163	72	3/21	F01	
F020T369ZA75	90	4	900	900	25	25	150	96	4/21	F01	
F020T299ZA75	90	4	900	900	25	25	166	90	1/21+3/19	F01	
F020T297ZA75	90	3	900	900	25	25	160	75	3/22	F01.70	

BESTELNR N° COMMANDE ORDER NR BESTELNR	BR LRG WID BR	BLADEN LAMES LEAVES BLATT.	B	C	D1	D2	PH FL FA SP	PAK EP TH PAK	DETAIL	MOD	OPMERKINGEN REMARKS REMARKS BEMERKUNGEN
---	------------------------	-------------------------------------	---	---	----	----	----------------------	------------------------	--------	-----	--

SERIE : -**1936****achter-arrière-rear-Hinten**

	A020T270ZC76	100	8/P/6	900	900	30	30	195	212		A01A	
A	A020T270ZC75	100	8	900	900	30	30	195	115	3/15+5/14	A01	
H	A020T270HC80	100	6	750	750	--	--	90	84	6/14	A08	
	A020T310ZC76	100	9/P/7	900	900	30	30	170	242		A01A	
A	A020T310ZC75	100	9	900	900	30	30	170	130	4/15+5/14	A01	
H	A020T310HC80	100	7	770	770	--	--	70	98	7/14	A08	
	A020T242ZC76	100	11/P/10	900	900	30	30	190	303		A01A	
A	A020T242ZC75	100	11	900	900	30	30	190	160	6/15+5/14	A01	
H	A020T242HC80	100	10	750	750	--	--	67	130	10/13	A08	
	A020T562ZA76	100	5/P/4	950	950	30	30	150	167		A01A	
A	A020T562ZA75	100	5	950	950	30	30	150	90	5/18	A01	
H	A020T562HA80	100	4	760	760	--	--	70	64	4/16	A08	
	A020T548ZA76	100	9/P/7	950	950	30	30	206	246		A01A	
A	A020T548ZA75	100	9	950	950	30	30	206	135	9/15	A01	
H	A020T548HA80	100	7	800	800	--	--	112	98	7/14	A08	
	A020T310ZB76	100	9/P/7	900	900	30	30	170	242		A01A.17	
A	A020T310ZB75	100	9	900	900	30	30	170	130	4/15+5/14	A01.17	
H	A020T310HB80	100	7	770	770	--	--	70	98	7/14	A08	
	A020T242ZB76	100	11/P/10	900	900	30	30	190	303		A01A.17	Vervangen
A	A020T242ZB75	100	11	900	900	30	30	190	160	5/15+1/14+1/15+4	A01.17	Vervangen
H	A020T242HB80	100	10	750	750	--	--	67	130	10/13	A08	
	F020T296ZA76	100	3/P/P/2	900	900	30	30	200	218		F01A	
A	F020T296ZA75	100	3	900	900	30	30	200	84	3/25	F01	
H	F020T296HA80	100	2	740	740	--	--	110	54	2/24	F08	
	F020T456ZA76	100	3/P/3	900	900	30	30	146	179		F01A	
A	F020T456ZA75	100	3	900	900	30	30	146	84	3/25	F01	
H	F020T456HA80	100	3	740	740	--	--	90	81	3/24	F08	
	F020T690ZA76	100	4/P/P/3	900	900	30	30	143	219		F01A	
A	F020T690ZA75	100	4	900	900	30	30	143	104	4/24	F01	
H	F020T690HA80	100	3	740	740	--	--	90	72	3/22	F08	

BESTELNR N° COMMANDE ORDER NR BESTELNR	BR LRG WID BR	BLADEN LAMES LEAVES BLATT.	B	C	D1	D2	PH FL FA SP	PAK EP TH PAK	DETAIL	MOD	OPMERKINGEN REMARQUES REMARKS BEMERKUNGEN
---	------------------------	-------------------------------------	---	---	----	----	----------------------	------------------------	--------	-----	--

SERIE : -**1938****voor-avant-front-Vorne**

A020T235ZB75	90	12	900	900	25	25	200	122	2/11+10/10	A01	
A020T323ZA75	90	12	900	900	25	25	90	175	7/15+5/14	A01	
A020T239ZB75	90	13	900	900	25	25	130	156	13/12	A01	
A020T485ZA75	90	14	900	900	25	25	65	198	2/15+12/14	A01	
A020T235ZA75	90	12	900	900	25	25	200	122	2/11+10/10	A01.16	Vervangen
F020T303ZA75	90	3	900	900	25	25	163	72	3/21	F01	
F020T299ZA75	90	4	900	900	25	25	166	90	1/21+3/19	F01	
F020T369ZA75	90	4	900	900	25	25	150	96	4/21	F01	
F020T617ZA75	90	2	750	570	30	30	24	35	2/13	F01.70	
F020T297ZA75	90	3	900	900	25	25	160	75	3/22	F01.70	

BESTELNR N° COMMANDE ORDER NR BESTELNR	BR LRG WID BR	BLADEN LAMES LEAVES BLATT.	B	C	D1	D2	PH FL FA SP	PAK EP TH PAK	DETAIL	MOD	OPMERKINGEN REMARKS REMARKS BEMERKUNGEN
---	------------------------	-------------------------------------	---	---	----	----	----------------------	------------------------	--------	-----	--

SERIE : -**1938****achter-arrière-rear-Hinten**

	A020T270ZC76	100	8/P/6	900	900	30	30	195	212		A01A	
A	A020T270ZC75	100	8	900	900	30	30	195	115	3/15+5/14	A01	
H	A020T270HC80	100	6	750	750	--	--	90	84	6/14	A08	
	A020T310ZC76	100	9/P/7	900	900	30	30	170	242		A01A	
A	A020T310ZC75	100	9	900	900	30	30	170	130	4/15+5/14	A01	
H	A020T310HC80	100	7	770	770	--	--	70	98	7/14	A08	
	A020T242ZC76	100	11/P/10	900	900	30	30	190	303		A01A	
A	A020T242ZC75	100	11	900	900	30	30	190	160	6/15+5/14	A01	
H	A020T242HC80	100	10	750	750	--	--	67	130	10/13	A08	
	A020T562ZA76	100	5/P/4	950	950	30	30	150	167		A01A	
A	A020T562ZA75	100	5	950	950	30	30	150	90	5/18	A01	
H	A020T562HA80	100	4	760	760	--	--	70	64	4/16	A08	
	A020T310ZB76	100	9/P/7	900	900	30	30	170	242		A01A.17	
A	A020T310ZB75	100	9	900	900	30	30	170	130	4/15+5/14	A01.17	
H	A020T310HB80	100	7	770	770	--	--	70	98	7/14	A08	
	A020T242ZB76	100	11/P/10	900	900	30	30	190	303		A01A.17	Vervangen
A	A020T242ZB75	100	11	900	900	30	30	190	160	5/15+1/14+1/15+4	A01.17	Vervangen
H	A020T242HB80	100	10	750	750	--	--	67	130	10/13	A08	
	F020T296ZA76	100	3/P/P/2	900	900	30	30	200	218		F01A	
A	F020T296ZA75	100	3	900	900	30	30	200	84	3/25	F01	
H	F020T296HA80	100	2	740	740	--	--	110	54	2/24	F08	
	F020T456ZA76	100	3/P/3	900	900	30	30	146	179		F01A	
A	F020T456ZA75	100	3	900	900	30	30	146	84	3/25	F01	
H	F020T456HA80	100	3	740	740	--	--	90	81	3/24	F08	
	F020T690ZA76	100	4/P/P/3	900	900	30	30	143	219		F01A	
A	F020T690ZA75	100	4	900	900	30	30	143	104	4/24	F01	
H	F020T690HA80	100	3	740	740	--	--	90	72	3/22	F08	
	F020T298ZA76	100	3/P/2	950	950	30	30	160	160		F01A	
A	F020T298ZA75	100	3	950	950	30	30	160	90	3/27	F01	
H	F020T298HA80	100	2	760	760	--	--	80	56	2/25	F08	

BESTELNR N° COMMANDE ORDER NR BESTELLNR	BR LRG WID BR	BLADEN LAMES LEAVES BLATT.	B	C	D1	D2	PH FL FA SP	PAK EP TH PAK	DETAIL	MOD	OPMERKINGEN REMARQUES REMARKS BEMERKUNGEN
--	------------------------	-------------------------------------	---	---	----	----	----------------------	------------------------	--------	-----	--

SERIE : -**1944****voor-avant-front-Vorne**

A020T323ZA75	90	12	900	900	25	25	90	175	7/15+5/14	A01	
A020T235ZB75	90	12	900	900	25	25	200	122	2/11+10/10	A01	
A020T239ZB75	90	13	900	900	25	25	130	156	13/12	A01	
A020T485ZA75	90	14	900	900	25	25	65	198	2/15+12/14	A01	
A020T235ZA75	90	12	900	900	25	25	200	122	2/11+10/10	A01.16	Vervangen
F020T303ZA75	90	3	900	900	25	25	163	72	3/21	F01	
F020T299ZA75	90	4	900	900	25	25	166	90	1/21+3/19	F01	
F020T369ZA75	90	4	900	900	25	25	150	96	4/21	F01	
F020T617ZA75	90	2	750	570	30	30	24	35	2/13	F01.70	

BESTELNR N° COMMANDE ORDER NR BESTELNR	BR LRG WID BR	BLADEN LAMES LEAVES BLATT.	B	C	D1	D2	PH FL FA SP	PAK EP TH PAK	DETAIL	MOD	OPMERKINGEN REMARKS BEMERKUNGEN
---	------------------------	-------------------------------------	---	---	----	----	----------------------	------------------------	--------	-----	---------------------------------------

SERIE : -**1944****achter-arrière-rear-Hinten**

	A020T270ZC76	100	8/P/6	900	900	30	30	195	212		A01A	
A	A020T270ZC75	100	8	900	900	30	30	195	115	3/15+5/14	A01	
H	A020T270HC80	100	6	750	750	--	--	90	84	6/14	A08	
	A020T310ZC76	100	9/P/7	900	900	30	30	170	242		A01A	
A	A020T310ZC75	100	9	900	900	30	30	170	130	4/15+5/14	A01	
H	A020T310HC80	100	7	770	770	--	--	70	98	7/14	A08	
	A020T242ZC76	100	11/P/10	900	900	30	30	190	303		A01A	
A	A020T242ZC75	100	11	900	900	30	30	190	160	6/15+5/14	A01	
H	A020T242HC80	100	10	750	750	--	--	67	130	10/13	A08	
	A020T562ZA76	100	5/P/4	950	950	30	30	150	167		A01A	
A	A020T562ZA75	100	5	950	950	30	30	150	90	5/18	A01	
H	A020T562HA80	100	4	760	760	--	--	70	64	4/16	A08	
	A020T548ZA76	100	9/P/7	950	950	30	30	206	246		A01A	
A	A020T548ZA75	100	9	950	950	30	30	206	135	9/15	A01	
H	A020T548HA80	100	7	800	800	--	--	112	98	7/14	A08	
	A020T310ZB76	100	9/P/7	900	900	30	30	170	242		A01A.17	
A	A020T310ZB75	100	9	900	900	30	30	170	130	4/15+5/14	A01.17	
H	A020T310HB80	100	7	770	770	--	--	70	98	7/14	A08	
	A020T242ZB76	100	11/P/10	900	900	30	30	190	303		A01A.17	Vervangen
A	A020T242ZB75	100	11	900	900	30	30	190	160	5/15+1/14+1/15+4	A01.17	Vervangen
H	A020T242HB80	100	10	750	750	--	--	67	130	10/13	A08	
	F020T296ZA76	100	3/P/P/2	900	900	30	30	200	218		F01A	
A	F020T296ZA75	100	3	900	900	30	30	200	84	3/25	F01	
H	F020T296HA80	100	2	740	740	--	--	110	54	2/24	F08	
	F020T456ZA76	100	3/P/3	900	900	30	30	146	179		F01A	
A	F020T456ZA75	100	3	900	900	30	30	146	84	3/25	F01	
H	F020T456HA80	100	3	740	740	--	--	90	81	3/24	F08	
	F020T690ZA76	100	4/P/P/3	900	900	30	30	143	219		F01A	
A	F020T690ZA75	100	4	900	900	30	30	143	104	4/24	F01	
H	F020T690HA80	100	3	740	740	--	--	90	72	3/22	F08	
	F020T298ZA76	100	3/P/2	950	950	30	30	160	160		F01A	
A	F020T298ZA75	100	3	950	950	30	30	160	90	3/27	F01	
H	F020T298HA80	100	2	760	760	--	--	80	56	2/25	F08	

BESTELNR N° COMMANDE ORDER NR BESTELLNR	BR LRG WID BR	BLADEN LAMES LEAVES BLATT.	B	C	D1	D2	PH FL FA SP	PAK EP TH PAK	DETAIL	MOD	OPMERKINGEN REMARQUES REMARKS BEMERKUNGEN
--	------------------------	-------------------------------------	---	---	----	----	----------------------	------------------------	--------	-----	--

SERIE : -**1948****voor-avant-front-Vorne**

A020T333ZA75	90	10	900	900	25	25	80	145	5/15+5/14	A01	
A020T615ZA75	90	13	900	900	S24	S24	120	158	2/13+11/12	A01	Silentbloc
A020T239ZB75	90	13	900	900	25	25	130	156	13/12	A01	
A020T243ZB75	90	10	900	900	25	25	80	145	5/15+5/14	A01.16	Vervangen
F020T303ZA75	90	3	900	900	25	25	163	72	3/21	F01	
F020T369ZA75	90	4	900	900	25	25	150	96	4/21	F01	
F020T299ZA75	90	4	900	900	25	25	166	90	1/21+3/19	F01	
F020T591ZA75	90	4	900	900	S24	S24	150	96	4/21	F01	
F020T503ZA75	90	4	900	900	25	25	132	100	4/22	F01	

BESTELNR N° COMMANDE ORDER NR BESTELNR	BR LRG WID BR	BLADEN LAMES LEAVES BLATT.	B	C	D1	D2	PH FL FA SP	PAK EP TH PAK	DETAIL	MOD	OPMERKINGEN REMARKS BEMERKUNGEN
---	------------------------	-------------------------------------	---	---	----	----	----------------------	------------------------	--------	-----	---------------------------------------

SERIE : -

1948

achter-arrière-rear-Hinten

	A020T270ZC76	100	8/P/6	900	900	30	30	195	212		A01A	
A	A020T270ZC75	100	8	900	900	30	30	195	115	3/15+5/14	A01	
H	A020T270HC80	100	6	750	750	--	--	90	84	6/14	A08	
	A020T684ZA76	100	9/P/7	900	900	S24	S24	170	242		A01A	Silentbloc
A	A020T684ZA75	100	9	900	900	S24	S24	170	130	4/15+5/14	A01	Silentbloc
H	A020T684HA80	100	7	745	745	--	--	80	98	7/14	A08	
	A020T310ZC76	100	9/P/7	900	900	30	30	170	242		A01A	
A	A020T310ZC75	100	9	900	900	30	30	170	130	4/15+5/14	A01	
H	A020T310HC80	100	7	770	770	--	--	70	98	7/14	A08	
	A020T242ZC76	100	11/P/10	900	900	30	30	190	303		A01A	
A	A020T242ZC75	100	11	900	900	30	30	190	160	6/15+5/14	A01	
H	A020T242HC80	100	10	750	750	--	--	67	130	10/13	A08	
	A020T310ZB76	100	9/P/7	900	900	30	30	170	242		A01A.17	
A	A020T310ZB75	100	9	900	900	30	30	170	130	4/15+5/14	A01.17	
H	A020T310HB80	100	7	770	770	--	--	70	98	7/14	A08	
	A020T242ZB76	100	11/P/10	900	900	30	30	190	303		A01A.17	Vervangen
A	A020T242ZB75	100	11	900	900	30	30	190	160	5/15+1/14+1/15+4	A01.17	Vervangen
H	A020T242HB80	100	10	750	750	--	--	67	130	10/13	A08	
	F020T746ZA76	100	3/P/P/2	900	900	S24	S24	195	213		F01A	Silentbloc
A	F020T746ZA75	100	3	900	900	S24	S24	195	81	2/25	F01	Silentbloc
H	F020T746HA80	100	2	740	740	--	--	129	52	2/24	F08	
	F020T296ZA76	100	3/P/P/2	900	900	30	30	200	218		F01A	
A	F020T296ZA75	100	3	900	900	30	30	200	84	3/25	F01	
H	F020T296HA80	100	2	740	740	--	--	110	54	2/24	F08	
	F020T724ZA76	100	3/P/3	900	900	S24	S24	145	173		F01A	Silentbloc
A	F020T724ZA75	100	3	900	900	S24	S24	145	81	3/25	F01	Silentbloc
H	F020T724HA80	100	3	740	740	--	--	96	78	3/24	F08	
	F020T456ZA76	100	3/P/3	900	900	30	30	146	179		F01A	
A	F020T456ZA75	100	3	900	900	30	30	146	84	3/25	F01	
H	F020T456HA80	100	3	740	740	--	--	90	81	3/24	F08	
	F020T690ZA76	100	4/P/P/3	900	900	30	30	143	219		F01A	
A	F020T690ZA75	100	4	900	900	30	30	143	104	4/24	F01	
H	F020T690HA80	100	3	740	740	--	--	90	72	3/22	F08	

BESTELNR N° COMMANDE ORDER NR BESTELLNR	BR LRG WID BR	BLADEN LAMES LEAVES BLATT.	B	C	D1	D2	PH FL FA SP	PAK EP TH PAK	DETAIL	MOD	OPMERKINGEN REMARQUES REMARKS BEMERKUNGEN
--	------------------------	-------------------------------------	---	---	----	----	----------------------	------------------------	--------	-----	--

SERIE : -

2025

voor-avant-front-Vorne

F020T405ZA75	80	4	860	860	25	25	181	85	1/20+3/19	F01.70
F020T567ZA75	90	2	750	570	30	30	-15	36	2/14	F01.70
F020T425ZA75	90	2	750	570	30	30	-12	37	2/14	F01.70

achter-arrière-rear-Hinten

A	F020T568ZA76	80	4/P/P/3	950	725	30	30	175	172		F01A
	F020T568ZA75	80	4	950	725	30	30	175	92	4/21	F01
H	F020T568HA80	80	3	770	550	--	--	150	60	3/18	F08

2028

voor-avant-front-Vorne

A020T311ZB75	90	9	900	900	25	25	135	117	9/13	A01
A020T333ZA75	90	10	900	900	25	25	80	145	5/15+5/14	A01
A020T243ZB75	90	10	900	900	25	25	80	145	5/15+5/14	A01.16 Vervangen
F020T303ZA75	90	3	900	900	25	25	163	72	3/21	F01
F020T369ZA75	90	4	900	900	25	25	150	96	4/21	F01
F020T299ZA75	90	4	900	900	25	25	166	90	1/21+3/19	F01
F020T453ZA75	90	2	750	570	30	30	28	35	2/13	F01.70
F020T617ZA75	90	2	750	570	30	30	24	35	2/13	F01.70

achter-arrière-rear-Hinten

A020T306ZA70	104	14	810	810	--	--	125	300	3/23+11/21	A08R
A020T660ZA70	104	11	815	815	--	--	120	187	11/17	A08R
A020T708ZA70	104	11	815	815	--	--	120	187	11/17	A08R
A020T506ZA70	104	16	820	820	--	--	120	336	16/21	A08R

BESTELNR N° COMMANDE ORDER NR BESTELNR	BR LRG WID BR	BLADEN LAMES LEAVES BLATT.	B	C	D1	D2	PH FL FA SP	PAK EP TH PAK	DETAIL	MOD	OPMERKINGEN REMARQUES REMARKS BEMERKUNGEN
---	------------------------	-------------------------------------	---	---	----	----	----------------------	------------------------	--------	-----	--

SERIE : -**2031****voor-avant-front-Vorne**

A020T311ZB75	90	9	900	900	25	25	135	117	9/13	A01	
A020T333ZA75	90	10	900	900	25	25	80	145	5/15+5/14	A01	
A020T607ZA75	90	10	900	900	S24	S24	75	145	5/15+5/14	A01	Silentbloc
A020T239ZB75	90	13	900	900	25	25	130	156	13/12	A01	
A020T615ZA75	90	13	900	900	S24	S24	120	158	2/13+11/12	A01	Silentbloc
A020T485ZA75	90	14	900	900	25	25	65	198	2/15+12/14	A01	
A020T623ZA75	90	14	900	900	S24	S24	70	198	2/15+12/14	A01	Silentbloc
A020T243ZB75	90	10	900	900	25	25	80	145	5/15+5/14	A01.16	Vervangen
F020T303ZA75	90	3	900	900	25	25	163	72	3/21	F01	
F020T611ZA75	90	3	900	900	25	25	108	78	3/23.5	F01	
F020T591ZA75	90	4	900	900	S24	S24	150	96	4/21	F01	
F020T595ZA75	90	4	900	900	S24	S24	152	104	4/23	F01	
F020T585ZA75	90	4	900	900	S24	S24	179	92	4/20	F01	
F020T503ZA75	90	4	900	900	25	25	132	100	4/22	F01	
F020T299ZA75	90	4	900	900	25	25	166	90	1/21+3/19	F01	
F020T369ZA75	90	4	900	900	25	25	150	96	4/21	F01	
F020T655ZA75	90	4	900	900	S24	S24	128	100	4/22	F01	
F020T617ZA75	90	2	750	570	30	30	24	35	2/13	F01.70	

BESTELNR N° COMMANDE ORDER NR BESTELLNR	BR LRG WID BR	BLADEN LAMES LEAVES BLATT.	B	C	D1	D2	PH FL FA SP	PAK EP TH PAK	DETAIL	MOD	OPMERKINGEN REMARKS REMARKS BEMERKUNGEN
--	------------------------	-------------------------------------	---	---	----	----	----------------------	------------------------	--------	-----	--

SERIE : -

2031

achter-arrière-rear-Hinten

A	A020T740ZA76	100	8/P/6	900	900	S24	S24	195	212		A01A	Silentbloc
H	A020T740ZA75	100	8	900	900	S24	S24		115	3/15+5/14	A01	Silentbloc
H	A020T740HA80	100	6	750	750			90	84	6/14	A08	
A	A020T270ZC76	100	8/P/6	900	900	30	30	195	212		A01A	
H	A020T270ZC75	100	8	900	900	30	30	195	115	3/15+5/14	A01	
H	A020T270HC80	100	6	750	750	--	--	90	84	6/14	A08	
A	A020T684ZA76	100	9/P/7	900	900	S24	S24	170	242		A01A	Silentbloc
H	A020T684ZA75	100	9	900	900	S24	S24	170	130	4/15+5/14	A01	Silentbloc
H	A020T684HA80	100	7	745	745	--	--	80	98	7/14	A08	
A	A020T310ZC76	100	9/P/7	900	900	30	30	170	242		A01A	
H	A020T310ZC75	100	9	900	900	30	30	170	130	4/15+5/14	A01	
H	A020T310HC80	100	7	770	770	--	--	70	98	7/14	A08	
A	A020T744ZA76	100	9/P/10	900	900	S24	S24		0		A01A	
H	A020T744ZA75											
H	A020T744HA80											
A	A020T742ZA76	100	11/P/10	900	900	S24	S24	190	303		A01A	Silentbloc
H	A020T742ZA75	100	11	900	900	S24	S24	190	160	6/15+5/14	A01	Silentbloc
H	A020T742HA80	100	10	750	750			67	130	10/13	A08	
A	A020T242ZC76	100	11/P/10	900	900	30	30	190	303		A01A	
H	A020T242ZC75	100	11	900	900	30	30	190	160	6/15+5/14	A01	
H	A020T242HC80	100	10	750	750	--	--	67	130	10/13	A08	
A	A020T548ZA76	100	9/P/7	950	950	30	30	206	246		A01A	
H	A020T548ZA75	100	9	950	950	30	30	206	135	9/15	A01	
H	A020T548HA80	100	7	800	800	--	--	112	98	7/14	A08	
A	A020T728ZA76	100	9/P/7	950	950	S24	S24	206	247		A01A	Silentbloc
H	A020T728ZA75	100	9	950	950	S24	S24	206	135	9/15	A01	Silentbloc
H	A020T728HA80	100	7	800	800	--	--	112	98	7/14	A08	
A	A020T310ZB76	100	9/P/7	900	900	30	30	170	242		A01A.17	
H	A020T310ZB75	100	9	900	900	30	30	170	130	4/15+5/14	A01.17	
H	A020T310HB80	100	7	770	770	--	--	70	98	7/14	A08	
A	A020T242ZB76	100	11/P/10	900	900	30	30	190	303		A01A.17	Vervangen
H	A020T242ZB75	100	11	900	900	30	30	190	160	5/15+1/14+1/15+4	A01.17	Vervangen
H	A020T242HB80	100	10	750	750	--	--	67	130	10/13	A08	
A	F020T746ZA76	100	3/P/P/2	900	900	S24	S24	195	213		F01A	Silentbloc
H	F020T746ZA75	100	3	900	900	S24	S24	195	81	2/25	F01	Silentbloc
H	F020T746HA80	100	2	740	740	--	--	129	52	2/24	F08	
A	F020T296ZA76	100	3/P/P/2	900	900	30	30	200	218		F01A	
H	F020T296ZA75	100	3	900	900	30	30	200	84	3/25	F01	
H	F020T296HA80	100	2	740	740	--	--	110	54	2/24	F08	
A	F020T724ZA76	100	3/P/3	900	900	S24	S24	145	173		F01A	Silentbloc
H	F020T724ZA75	100	3	900	900	S24	S24	145	81	3/25	F01	Silentbloc
H	F020T724HA80	100	3	740	740	--	--	96	78	3/24	F08	

BESTELNR N° COMMANDE ORDER NR BESTELNR	BR LRG WID BR	BLADEN LAMES LEAVES BLATT.	B	C	D1	D2	PH FL FA SP	PAK EP TH PAK	DETAIL	MOD	OPMERKINGEN REMARQUES REMARKS BEMERKUNGEN
---	------------------------	-------------------------------------	---	---	----	----	----------------------	------------------------	--------	-----	--

SERIE : -

2031

	F020T456ZA76	100	3/P/3	900	900	30	30	146	179		F01A	
A	F020T456ZA75	100	3	900	900	30	30	146	84	3/25	F01	
H	F020T456HA80	100	3	740	740	--	--	90	81	3/24	F08	
	F020T690ZA76	100	4/P/P/3	900	900	30	30	143	219		F01A	
A	F020T690ZA75	100	4	900	900	30	30	143	104	4/24	F01	
H	F020T690HA80	100	3	740	740	--	--	90	72	3/22	F08	
	F020T682ZA76	100	4/P/P/3	900	900	S24	S24	147	220		F01A	Silentbloc
A	F020T682ZA75	100	4	900	900	S24	S24	147	104	4/24	F01	Silentbloc
H	F020T682HA80	100	3	740	740	--	--	85	72	3/22	F08	
	F020T678ZA76	100	3/P/2	950	950	S24	S24	160	155		F01A	Silentbloc
A	F020T678ZA75	100	3	950	950	S24	S24	160	87	3/27	F01	Silentbloc
H	F020T678HA80	100	2	760	760	--	--	85	54	2/25	F08	
	F020T298ZA76	100	3/P/2	950	950	30	30	160	160		F01A	
A	F020T298ZA75	100	3	950	950	30	30	160	90	3/27	F01	
H	F020T298HA80	100	2	760	760	--	--	80	56	2/25	F08	

2033

voor-avant-front-Vorne

	F020T303ZA75	90	3	900	900	25	25	163	72	3/21	F01	
	F020T369ZA75	90	4	900	900	25	25	150	96	4/21	F01	
	F020T299ZA75	90	4	900	900	25	25	166	90	1/21+3/19	F01	
	F020T383ZA75	90	2	750	570	30	30	28			F01.70	
	F020T453ZA75	90	2	750	570	30	30	28	35	2/13	F01.70	
	F020T617ZA75	90	2	750	570	30	30	24	35	2/13	F01.70	

BESTELNR N° COMMANDE ORDER NR BESTELNR	BR LRG WID BR	BLADEN LAMES LEAVES BLATT.	B	C	D1	D2	PH FL FA SP	PAK EP TH PAK	DETAIL	MOD	OPMERKINGEN REMARQUES REMARKS BEMERKUNGEN
---	------------------------	-------------------------------------	---	---	----	----	----------------------	------------------------	--------	-----	--

SERIE : -**2035****voor-avant-front-Vorne**

F020T303ZA75	90	3	900	900	25	25	163	72	3/21	F01
F020T369ZA75	90	4	900	900	25	25	150	96	4/21	F01
F020T299ZA75	90	4	900	900	25	25	166	90	1/21+3/19	F01
F020T453ZA75	90	2	750	570	30	30	28	35	2/13	F01.70
F020T567ZA75	90	2	750	570	30	30	-15	36	2/14	F01.70
F020T617ZA75	90	2	750	570	30	30	24	35	2/13	F01.70
F020T425ZA75	90	2	750	570	30	30	-12	37	2/14	F01.70

achter-arrière-rear-Hinten

	F020T308ZA76	100	3/P/1	950	950	30	30	132	122		F01A
A	F020T308ZA75	100	3	950	950	30	30	132	84	3/26	F01
H	F020T308HA80	100	1	760	760	--	--	130	22	1/22	F08
	F020T626ZA76	100	3/P/2	950	950	30	30	168	143		F01A
A	F020T626ZA75	100	3	950	950	30	30	168	87	3/26	F01
H	F020T626HA80	100	2	765	765	--	--	108	48	2/21	F08

2036**voor-avant-front-Vorne**

F020T303ZA75	90	3	900	900	25	25	163	72	3/21	F01
F020T299ZA75	90	4	900	900	25	25	166	90	1/21+3/19	F01
F020T369ZA75	90	4	900	900	25	25	150	96	4/21	F01
F020T383ZA75	90	2	750	570	30	30	28			F01.70
F020T453ZA75	90	2	750	570	30	30	28	35	2/13	F01.70
F020T617ZA75	90	2	750	570	30	30	24	35	2/13	F01.70

BESTELNR N° COMMANDE ORDER NR BESTELLNR	BR LRG WID BR	BLADEN LAMES LEAVES BLATT.	B	C	D1	D2	PH FL FA SP	PAK EP TH PAK	DETAIL	MOD	OPMERKINGEN REMARQUES REMARKS BEMERKUNGEN
--	------------------------	-------------------------------------	---	---	----	----	----------------------	------------------------	--------	-----	--

SERIE : -**2038****voor-avant-front-Vorne**

A020T615ZA75	90	13	900	900	S24	S24	120	158	2/13+11/12	A01	Silentbloc
A020T239ZB75	90	13	900	900	25	25	130	156	13/12	A01	
A020T485ZA75	90	14	900	900	25	25	65	198	2/15+12/14	A01	
A020T623ZA75	90	14	900	900	S24	S24	70	198	2/15+12/14	A01	Silentbloc
F020T611ZA75	90	3	900	900	25	25	108	78	3/23.5	F01	
F020T303ZA75	90	3	900	900	25	25	163	72	3/21	F01	
F020T585ZA75	90	4	900	900	S24	S24	179	92	4/20	F01	
F020T503ZA75	90	4	900	900	25	25	132	100	4/22	F01	
F020T595ZA75	90	4	900	900	S24	S24	152	104	4/23	F01	
F020T369ZA75	90	4	900	900	25	25	150	96	4/21	F01	
F020T591ZA75	90	4	900	900	S24	S24	150	96	4/21	F01	
F020T655ZA75	90	4	900	900	S24	S24	128	100	4/22	F01	

BESTELNR N° COMMANDE ORDER NR BESTELNR	BR LRG WID BR	BLADEN LAMES LEAVES BLATT.	B	C	D1	D2	PH FL FA SP	PAK EP TH PAK	DETAIL	MOD	OPMERKINGEN REMARQUES REMARKS BEMERKUNGEN
---	------------------------	-------------------------------------	---	---	----	----	----------------------	------------------------	--------	-----	--

SERIE : -

2038

achter-arrière-rear-Hinten

A	A020T310ZC76	100	9/P/7	900	900	30	30	170	242		A01A	
H	A020T310ZC75	100	9	900	900	30	30	170	130	4/15+5/14	A01	
H	A020T310HC80	100	7	770	770	--	--	70	98	7/14	A08	
A	A020T684ZA76	100	9/P/7	900	900	S24	S24	170	242		A01A	Silentbloc
H	A020T684ZA75	100	9	900	900	S24	S24	170	130	4/15+5/14	A01	Silentbloc
H	A020T684HA80	100	7	745	745	--	--	80	98	7/14	A08	
A	A020T744ZA76	100	9/P/10	900	900	S24	S24		0		A01A	
H	A020T744ZA75											
H	A020T744HA80											
A	A020T242ZC76	100	11/P/10	900	900	30	30	190	303		A01A	
H	A020T242ZC75	100	11	900	900	30	30	190	160	6/15+5/14	A01	
H	A020T242HC80	100	10	750	750	--	--	67	130	10/13	A08	
A	A020T742ZA76	100	11/P/10	900	900	S24	S24	190	303		A01A	Silentbloc
H	A020T742ZA75	100	11	900	900	S24	S24	190	160	6/15+5/14	A01	Silentbloc
H	A020T742HA80	100	10	750	750			67	130	10/13	A08	
A	A020T728ZA76	100	9/P/7	950	950	S24	S24	206	247		A01A	Silentbloc
H	A020T728ZA75	100	9	950	950	S24	S24	206	135	9/15	A01	Silentbloc
H	A020T728HA80	100	7	800	800	--	--	112	98	7/14	A08	
A	A020T548ZA76	100	9/P/7	950	950	30	30	206	246		A01A	
H	A020T548ZA75	100	9	950	950	30	30	206	135	9/15	A01	
H	A020T548HA80	100	7	800	800	--	--	112	98	7/14	A08	
A	A020T310ZB76	100	9/P/7	900	900	30	30	170	242		A01A.17	
H	A020T310ZB75	100	9	900	900	30	30	170	130	4/15+5/14	A01.17	
H	A020T310HB80	100	7	770	770	--	--	70	98	7/14	A08	
A	A020T242ZB76	100	11/P/10	900	900	30	30	190	303		A01A.17	Vervangen
H	A020T242ZB75	100	11	900	900	30	30	190	160	5/15+1/14+1/15+4	A01.17	Vervangen
H	A020T242HB80	100	10	750	750	--	--	67	130	10/13	A08	
A	F020T746ZA76	100	3/P/P/2	900	900	S24	S24	195	213		F01A	Silentbloc
H	F020T746ZA75	100	3	900	900	S24	S24	195	81	2/25	F01	Silentbloc
H	F020T746HA80	100	2	740	740	--	--	129	52	2/24	F08	
A	F020T296ZA76	100	3/P/P/2	900	900	30	30	200	218		F01A	
H	F020T296ZA75	100	3	900	900	30	30	200	84	3/25	F01	
H	F020T296HA80	100	2	740	740	--	--	110	54	2/24	F08	
A	F020T724ZA76	100	3/P/3	900	900	S24	S24	145	173		F01A	Silentbloc
H	F020T724ZA75	100	3	900	900	S24	S24	145	81	3/25	F01	Silentbloc
H	F020T724HA80	100	3	740	740	--	--	96	78	3/24	F08	
A	F020T456ZA76	100	3/P/3	900	900	30	30	146	179		F01A	
H	F020T456ZA75	100	3	900	900	30	30	146	84	3/25	F01	
H	F020T456HA80	100	3	740	740	--	--	90	81	3/24	F08	
A	F020T682ZA76	100	4/P/P/3	900	900	S24	S24	147	220		F01A	Silentbloc
H	F020T682ZA75	100	4	900	900	S24	S24	147	104	4/24	F01	Silentbloc
H	F020T682HA80	100	3	740	740	--	--	85	72	3/22	F08	

BESTELNR N° COMMANDE ORDER NR BESTELLNR	BR LRG WID BR	BLADEN LAMES LEAVES BLATT.	B	C	D1	D2	PH FL FA SP	PAK EP TH PAK	DETAIL	MOD	OPMERKINGEN REMARQUES REMARKS BEMERKUNGEN
--	------------------------	-------------------------------------	---	---	----	----	----------------------	------------------------	--------	-----	--

SERIE : -

2038

	F020T690ZA76	100	4/P/P/3	900	900	30	30	143	219		F01A	
A	F020T690ZA75	100	4	900	900	30	30	143	104	4/24	F01	
H	F020T690HA80	100	3	740	740	--	--	90	72	3/22	F08	
	F020T678ZA76	100	3/P/2	950	950	S24	S24	160	155		F01A	Silentbloc
A	F020T678ZA75	100	3	950	950	S24	S24	160	87	3/27	F01	Silentbloc
H	F020T678HA80	100	2	760	760	--	--	85	54	2/25	F08	

BESTELNR N° COMMANDE ORDER NR BESTELLNR	BR LRG WID BR	BLADEN LAMES LEAVES BLATT.	B	C	D1	D2	PH FL FA SP	PAK EP TH PAK	DETAIL	MOD	OPMERKINGEN REMARQUES REMARKS BEMERKUNGEN
--	------------------------	-------------------------------------	---	---	----	----	----------------------	------------------------	--------	-----	--

SERIE : -**2044****voor-avant-front-Vorne**

A020T615ZA75	90	13	900	900	S24	S24	120	158	2/13+11/12	A01	Silentbloc
A020T239ZB75	90	13	900	900	25	25	130	156	13/12	A01	
A020T485ZA75	90	14	900	900	25	25	65	198	2/15+12/14	A01	
A020T623ZA75	90	14	900	900	S24	S24	70	198	2/15+12/14	A01	Silentbloc
F020T611ZA75	90	3	900	900	25	25	108	78	3/23.5	F01	
F020T303ZA75	90	3	900	900	25	25	163	72	3/21	F01	
F020T655ZA75	90	4	900	900	S24	S24	128	100	4/22	F01	
F020T369ZA75	90	4	900	900	25	25	150	96	4/21	F01	
F020T503ZA75	90	4	900	900	25	25	132	100	4/22	F01	
F020T585ZA75	90	4	900	900	S24	S24	179	92	4/20	F01	
F020T591ZA75	90	4	900	900	S24	S24	150	96	4/21	F01	
F020T595ZA75	90	4	900	900	S24	S24	152	104	4/23	F01	

BESTELNR N° COMMANDE ORDER NR BESTELNR	BR LRG WID BR	BLADEN LAMES LEAVES BLATT.	B	C	D1	D2	PH FL FA SP	PAK EP TH PAK	DETAIL	MOD	OPMERKINGEN REMARQUES REMARKS BEMERKUNGEN
---	------------------------	-------------------------------------	---	---	----	----	----------------------	------------------------	--------	-----	--

SERIE : -

2044

achter-arrière-rear-Hinten

A	A020T684ZA76	100	9/P/7	900	900	S24	S24	170	242		A01A	Silentbloc
H	A020T684ZA75	100	9	900	900	S24	S24	170	130	4/15+5/14	A01	Silentbloc
H	A020T684HA80	100	7	745	745	--	--	80	98	7/14	A08	
A	A020T310ZC76	100	9/P/7	900	900	30	30	170	242		A01A	
H	A020T310ZC75	100	9	900	900	30	30	170	130	4/15+5/14	A01	
H	A020T310HC80	100	7	770	770	--	--	70	98	7/14	A08	
A	A020T242ZC76	100	11/P/10	900	900	30	30	190	303		A01A	
H	A020T242ZC75	100	11	900	900	30	30	190	160	6/15+5/14	A01	
H	A020T242HC80	100	10	750	750	--	--	67	130	10/13	A08	
A	A020T742ZA76	100	11/P/10	900	900	S24	S24	190	303		A01A	Silentbloc
H	A020T742ZA75	100	11	900	900	S24	S24	190	160	6/15+5/14	A01	Silentbloc
H	A020T742HA80	100	10	750	750			67	130	10/13	A08	
A	A020T548ZA76	100	9/P/7	950	950	30	30	206	246		A01A	
H	A020T548ZA75	100	9	950	950	30	30	206	135	9/15	A01	
H	A020T548HA80	100	7	800	800	--	--	112	98	7/14	A08	
A	A020T728ZA76	100	9/P/7	950	950	S24	S24	206	247		A01A	Silentbloc
H	A020T728ZA75	100	9	950	950	S24	S24	206	135	9/15	A01	Silentbloc
H	A020T728HA80	100	7	800	800	--	--	112	98	7/14	A08	
A	A020T310ZB76	100	9/P/7	900	900	30	30	170	242		A01A.17	
H	A020T310ZB75	100	9	900	900	30	30	170	130	4/15+5/14	A01.17	
H	A020T310HB80	100	7	770	770	--	--	70	98	7/14	A08	
A	A020T242ZB76	100	11/P/10	900	900	30	30	190	303		A01A.17	Vervangen
H	A020T242ZB75	100	11	900	900	30	30	190	160	5/15+1/14+1/15+4	A01.17	Vervangen
H	A020T242HB80	100	10	750	750	--	--	67	130	10/13	A08	
A	F020T296ZA76	100	3/P/P/2	900	900	30	30	200	218		F01A	
H	F020T296ZA75	100	3	900	900	30	30	200	84	3/25	F01	
H	F020T296HA80	100	2	740	740	--	--	110	54	2/24	F08	
A	F020T746ZA76	100	3/P/P/2	900	900	S24	S24	195	213		F01A	Silentbloc
H	F020T746ZA75	100	3	900	900	S24	S24	195	81	2/25	F01	Silentbloc
H	F020T746HA80	100	2	740	740	--	--	129	52	2/24	F08	
A	F020T724ZA76	100	3/P/3	900	900	S24	S24	145	173		F01A	Silentbloc
H	F020T724ZA75	100	3	900	900	S24	S24	145	81	3/25	F01	Silentbloc
H	F020T724HA80	100	3	740	740	--	--	96	78	3/24	F08	
A	F020T456ZA76	100	3/P/3	900	900	30	30	146	179		F01A	
H	F020T456ZA75	100	3	900	900	30	30	146	84	3/25	F01	
H	F020T456HA80	100	3	740	740	--	--	90	81	3/24	F08	
A	F020T690ZA76	100	4/P/P/3	900	900	30	30	143	219		F01A	
H	F020T690ZA75	100	4	900	900	30	30	143	104	4/24	F01	
H	F020T690HA80	100	3	740	740	--	--	90	72	3/22	F08	
A	F020T682ZA76	100	4/P/P/3	900	900	S24	S24	147	220		F01A	Silentbloc
H	F020T682ZA75	100	4	900	900	S24	S24	147	104	4/24	F01	Silentbloc
H	F020T682HA80	100	3	740	740	--	--	85	72	3/22	F08	

BESTELNR N° COMMANDE ORDER NR BESTELLNR	BR LRG WID BR	BLADEN LAMES LEAVES BLATT.	B	C	D1	D2	PH FL FA SP	PAK EP TH PAK	DETAIL	MOD	OPMERKINGEN REMARQUES REMARKS BEMERKUNGEN
--	------------------------	-------------------------------------	---	---	----	----	----------------------	------------------------	--------	-----	--

SERIE : -

2044

	F020T678ZA76	100	3/P/2	950	950	S24	S24	160	155		F01A	Silentbloc
A	F020T678ZA75	100	3	950	950	S24	S24	160	87	3/27	F01	Silentbloc
H	F020T678HA80	100	2	760	760	--	--	85	54	2/25	F08	
	F020T298ZA76	100	3/P/2	950	950	30	30	160	160		F01A	
A	F020T298ZA75	100	3	950	950	30	30	160	90	3/27	F01	
H	F020T298HA80	100	2	760	760	--	--	80	56	2/25	F08	

BESTELNR N° COMMANDE ORDER NR BESTELLNR	BR LRG WID BR	BLADEN LAMES LEAVES BLATT.	B	C	D1	D2	PH FL FA SP	PAK EP TH PAK	DETAIL	MOD	OPMERKINGEN REMARQUES REMARKS BEMERKUNGEN
--	------------------------	-------------------------------------	---	---	----	----	----------------------	------------------------	--------	-----	--

SERIE : -

2050

voor-avant-front-Vorne

A020T239ZB75	90	13	900	900	25	25	130	156	13/12	A01	
A020T615ZA75	90	13	900	900	S24	S24	120	158	2/13+11/12	A01	Silentbloc
A020T485ZA75	90	14	900	900	25	25	65	198	2/15+12/14	A01	
F020T303ZA75	90	3	900	900	25	25	163	72	3/21	F01	
F020T611ZA75	90	3	900	900	25	25	108	78	3/23.5	F01	
F020T369ZA75	90	4	900	900	25	25	150	96	4/21	F01	
F020T585ZA75	90	4	900	900	S24	S24	179	92	4/20	F01	
F020T591ZA75	90	4	900	900	S24	S24	150	96	4/21	F01	
F020T503ZA75	90	4	900	900	25	25	132	100	4/22	F01	

BESTELNR N° COMMANDE ORDER NR BESTELNR	BR LRG WID BR	BLADEN LAMES LEAVES BLATT.	B	C	D1	D2	PH FL FA SP	PAK EP TH PAK	DETAIL	MOD	OPMERKINGEN REMARKS REMARKS BEMERKUNGEN
---	------------------------	-------------------------------------	---	---	----	----	----------------------	------------------------	--------	-----	--

SERIE : -**2050****achter-arrière-rear-Hinten**

A	A020T310ZC76	100	9/P/7	900	900	30	30	170	242		A01A	
H	A020T310ZC75	100	9	900	900	30	30	170	130	4/15+5/14	A01	
H	A020T310HC80	100	7	770	770	--	--	70	98	7/14	A08	
A	A020T684ZA76	100	9/P/7	900	900	S24	S24	170	242		A01A	Silentbloc
H	A020T684ZA75	100	9	900	900	S24	S24	170	130	4/15+5/14	A01	Silentbloc
H	A020T684HA80	100	7	745	745	--	--	80	98	7/14	A08	
A	A020T242ZC76	100	11/P/10	900	900	30	30	190	303		A01A	
H	A020T242ZC75	100	11	900	900	30	30	190	160	6/15+5/14	A01	
H	A020T242HC80	100	10	750	750	--	--	67	130	10/13	A08	
A	A020T728ZA76	100	9/P/7	950	950	S24	S24	206	247		A01A	Silentbloc
H	A020T728ZA75	100	9	950	950	S24	S24	206	135	9/15	A01	Silentbloc
H	A020T728HA80	100	7	800	800	--	--	112	98	7/14	A08	
A	A020T548ZA76	100	9/P/7	950	950	30	30	206	246		A01A	
H	A020T548ZA75	100	9	950	950	30	30	206	135	9/15	A01	
H	A020T548HA80	100	7	800	800	--	--	112	98	7/14	A08	
A	A020T310ZB76	100	9/P/7	900	900	30	30	170	242		A01A.17	
H	A020T310ZB75	100	9	900	900	30	30	170	130	4/15+5/14	A01.17	
H	A020T310HB80	100	7	770	770	--	--	70	98	7/14	A08	
A	A020T242ZB76	100	11/P/10	900	900	30	30	190	303		A01A.17	Vervangen
H	A020T242ZB75	100	11	900	900	30	30	190	160	5/15+1/14+1/15+4	A01.17	Vervangen
H	A020T242HB80	100	10	750	750	--	--	67	130	10/13	A08	
A	F020T296ZA76	100	3/P/P/2	900	900	30	30	200	218		F01A	
H	F020T296ZA75	100	3	900	900	30	30	200	84	3/25	F01	
H	F020T296HA80	100	2	740	740	--	--	110	54	2/24	F08	
A	F020T746ZA76	100	3/P/P/2	900	900	S24	S24	195	213		F01A	Silentbloc
H	F020T746ZA75	100	3	900	900	S24	S24	195	81	2/25	F01	Silentbloc
H	F020T746HA80	100	2	740	740	--	--	129	52	2/24	F08	
A	F020T724ZA76	100	3/P/3	900	900	S24	S24	145	173		F01A	Silentbloc
H	F020T724ZA75	100	3	900	900	S24	S24	145	81	3/25	F01	Silentbloc
H	F020T724HA80	100	3	740	740	--	--	96	78	3/24	F08	
A	F020T456ZA76	100	3/P/3	900	900	30	30	146	179		F01A	
H	F020T456ZA75	100	3	900	900	30	30	146	84	3/25	F01	
H	F020T456HA80	100	3	740	740	--	--	90	81	3/24	F08	
A	F020T690ZA76	100	4/P/P/3	900	900	30	30	143	219		F01A	
H	F020T690ZA75	100	4	900	900	30	30	143	104	4/24	F01	
H	F020T690HA80	100	3	740	740	--	--	90	72	3/22	F08	
A	F020T298ZA76	100	3/P/2	950	950	30	30	160	160		F01A	
H	F020T298ZA75	100	3	950	950	30	30	160	90	3/27	F01	
H	F020T298HA80	100	2	760	760	--	--	80	56	2/25	F08	
A	F020T678ZA76	100	3/P/2	950	950	S24	S24	160	155		F01A	Silentbloc
H	F020T678ZA75	100	3	950	950	S24	S24	160	87	3/27	F01	Silentbloc
H	F020T678HA80	100	2	760	760	--	--	85	54	2/25	F08	

BESTELNR N° COMMANDE ORDER NR BESTELNR	BR LRG WID BR	BLADEN LAMES LEAVES BLATT.	B	C	D1	D2	PH FL FA SP	PAK EP TH PAK	DETAIL	MOD	OPMERKINGEN REMARQUES REMARKS BEMERKUNGEN
---	------------------------	-------------------------------------	---	---	----	----	----------------------	------------------------	--------	-----	--

SERIE : -

2219

voor-avant-front-Vorne

A020T463ZA75	80	10/P	860	860	25	25	138	142	10/13+P/12	A01
A020T321ZA75	80	10/P	860	860	25	25	155	140	10/13+P/10	A01
A020T281ZA75	80	10/P	860	860	25	25	155	140	10/13+P/10	A01.17
A020T457ZA75	80	11/2	860	860	25	25	184	151	1/14+10/10,5+2/1	A01B
F020T363ZA75	80	3	860	860	25	25	145	75	3/23	F01.70
F020T567ZA75	90	2	750	570	30	30	-15	36	2/14	F01.70

achter-arrière-rear-Hinten

A020T478ZA76	80	11/P/10	950	730	30	30	165	310		A01A
A020T478ZA75	80	11	950	730	30	30	165	160	11/14,5	A01
A020T478HA80	80	10	770	545	--	--	35	130	10/13	A08
A020T320ZB76	80	7/P/7	956	956	30	30	220	244		A01A
A020T320ZB75	80	7	956	956	30	30	220	112	7/16	A01
A020T320HB80	80	7	770	770	--	--	120	112	7/16	A08
A020T320ZA76	80	7/P/7	956	956	30	30	220	244		A01A.17
A020T320ZA75	80	7	956	956	30	30	220	112	7/16	A01.17
A020T320HA80	80	7	770	770	--	--	220	112	7/16	A08
A020T276ZA75	80	9/5	792	622	30	30	159	186	2/13+7/10+5/18	A01B

BESTELNR N° COMMANDE ORDER NR BESTELNR	BR LRG WID BR	BLADEN LAMES LEAVES BLATT.	B	C	D1	D2	PH FL FA SP	PAK EP TH PAK	DETAIL	MOD	OPMERKINGEN REMARQUES REMARKS BEMERKUNGEN
---	------------------------	-------------------------------------	---	---	----	----	----------------------	------------------------	--------	-----	--

SERIE : -

2220

voor-avant-front-Vorne

A020T463ZA75	80	10/P	860	860	25	25	138	142	10/13+P/12	A01
A020T321ZA75	80	10/P	860	860	25	25	155	140	10/13+P/10	A01
A020T281ZA75	80	10/P	860	860	25	25	155	140	10/13+P/10	A01.17
A020T455ZA75	80	9/2/P	860	860	25	25	157	142	9/11,5+2/15+P/8	A01B
A020T457ZA75	80	11/2	860	860	25	25	184	151	1/14+10/10,5+2/1	A01B
F020T363ZA75	80	3	860	860	25	25	145	75	3/23	F01.70
F020T415ZA75	80	3	860	860	25	25	172	75	3/23	F01.70
F020T617ZA75	90	2	750	570	30	30	24	35	2/13	F01.70
F020T425ZA75	90	2	750	570	30	30	-12	37	2/14	F01.70
F020T453ZA75	90	2	750	570	30	30	28	35	2/13	F01.70
F020T567ZA75	90	2	750	570	30	30	-15	36	2/14	F01.70

achter-arrière-rear-Hinten

A020T478ZA76	80	11/P/10	950	730	30	30	165	310		A01A
A A020T478ZA75	80	11	950	730	30	30	165	160	11/14,5	A01
H A020T478HA80	80	10	770	545	--	--	35	130	10/13	A08
A020T320ZB76	80	7/P/7	956	956	30	30	220	244		A01A
A A020T320ZB75	80	7	956	956	30	30	220	112	7/16	A01
H A020T320HB80	80	7	770	770	--	--	120	112	7/16	A08
A020T320ZA76	80	7/P/7	956	956	30	30	220	244		A01A.17
A A020T320ZA75	80	7	956	956	30	30	220	112	7/16	A01.17
H A020T320HA80	80	7	770	770	--	--	220	112	7/16	A08
A020T276ZA75	80	9/5	792	622	30	30	159	186	2/13+7/10+5/18	A01B

BESTELNR N° COMMANDE ORDER NR BESTELNR	BR LRG WID BR	BLADEN LAMES LEAVES BLATT.	B	C	D1	D2	PH FL FA SP	PAK EP TH PAK	DETAIL	MOD	OPMERKINGEN REMARKS BEMERKUNGEN
---	------------------------	-------------------------------------	---	---	----	----	----------------------	------------------------	--------	-----	---------------------------------------

SERIE : -**2222****voor-avant-front-Vorne**

A020T463ZA75	80	10/P	860	860	25	25	138	142	10/13+P/12	A01
A020T321ZA75	80	10/P	860	860	25	25	155	140	10/13+P/10	A01
A020T281ZA75	80	10/P	860	860	25	25	155	140	10/13+P/10	A01.17
A020T455ZA75	80	9/2/P	860	860	25	25	157	142	9/11,5+2/15+P/8	A01B
A020T457ZA75	80	11/2	860	860	25	25	184	151	1/14+10/10,5+2/1	A01B
F020T363ZA75	80	3	860	860	25	25	145	75	3/23	F01.70
F020T477ZA75	80	4	860	860	25	25	151	96	4/22	F01.70
F020T425ZA75	90	2	750	570	30	30	-12	37	2/14	F01.70
F020T567ZA75	90	2	750	570	30	30	-15	36	2/14	F01.70

achter-arrière-rear-Hinten

A	A020T478ZA76	80	11/P/10	950	730	30	30	165	310		A01A
H	A020T478ZA75	80	11	950	730	30	30	165	160	11/14,5	A01
H	A020T478HA80	80	10	770	545	--	--	35	130	10/13	A08
A	A020T320ZB76	80	7/P/7	956	956	30	30	220	244		A01A
H	A020T320ZB75	80	7	956	956	30	30	220	112	7/16	A01
H	A020T320HB80	80	7	770	770	--	--	120	112	7/16	A08
A	A020T320ZA76	80	7/P/7	956	956	30	30	220	244		A01A.17
H	A020T320ZA75	80	7	956	956	30	30	220	112	7/16	A01.17
H	A020T320HA80	80	7	770	770	--	--	220	112	7/16	A08
	A020T276ZA75	80	9/5	792	622	30	30	159	186	2/13+7/10+5/18	A01B
	A020T390ZA70	90	11	745	745	--	--	65	220	11/20	A08R
	A020T380ZA70	94	11	745	745	--	--	94	198	11/18	A08R
	A020T354ZA70	94	14	750	750	--	--	100	252	14/18	A08R
	F020T598ZA70	90	6	740	740	--	--		183	3/30+3/27	F08R
	F020T590ZA70	93	6	750	750	--	--	78	214	4/33+2/35	F08R
	F020T536ZA70	93	5	765	765	--	--	113	165	5/31	F08R

BESTELNR N° COMMANDE ORDER NR BESTELLNR	BR LRG WID BR	BLADEN LAMES LEAVES BLATT.	B	C	D1	D2	PH FL FA SP	PAK EP TH PAK	DETAIL	MOD	OPMERKINGEN REMARQUES REMARKS BEMERKUNGEN
--	------------------------	-------------------------------------	---	---	----	----	----------------------	------------------------	--------	-----	--

SERIE : -

2225

voor-avant-front-Vorne

A020T321ZA75	80	10/P	860	860	25	25	155	140	10/13+P/10	A01
A020T463ZA75	80	10/P	860	860	25	25	138	142	10/13+P/12	A01
A020T281ZA75	80	10/P	860	860	25	25	155	140	10/13+P/10	A01.17
A020T457ZA75	80	11/2	860	860	25	25	184	151	1/14+10/10,5+2/1	A01B
F020T551ZA75	80	3/W	860	860	30	25	214	87	3/23+W	F01
F020T549ZA75	80	3/P	860	860	25	25	128	98	3/23+P/23	F01
F020T363ZA75	80	3	860	860	25	25	145	75	3/23	F01.70
F020T477ZA75	80	4	860	860	25	25	151	96	4/22	F01.70
F020T479ZA75	80	4	860	860	30	25	205	96	4/22	F01.70
F020T553ZA75	80	4	860	860	25	25	147	96	4/22	F01.70
F020T617ZA75	90	2	750	570	30	30	24	35	2/13	F01.70
F020T567ZA75	90	2	750	570	30	30	-15	36	2/14	F01.70

BESTELNR N° COMMANDE ORDER NR BESTELNR	BR LRG WID BR	BLADEN LAMES LEAVES BLATT.	B	C	D1	D2	PH FL FA SP	PAK EP TH PAK	DETAIL	MOD	OPMERKINGEN REMARQUES REMARKS BEMERKUNGEN
---	------------------------	-------------------------------------	---	---	----	----	----------------------	------------------------	--------	-----	--

SERIE : -**2225****achter-arrière-rear-Hinten**

	A020T400ZA76	80	9/P/9	725	950	30	30	145	268		A01A
A	A020T400ZA75	80	9	725	950	30	30	145	131	9/14,5	A01
H	A020T400HA80	80	9	525	750	--	--	40	113	9/12,5	A08
	A020T540ZA76	80	13/P/10	950	725	30	30	100	309		A01A
A	A020T540ZA75	80	13	950	725	30	30	100	169	13/13	A01
H	A020T540HA80	80	10	770	545	--	--	11	120	10/12	A08
	A020T478ZA76	80	11/P/10	950	730	30	30	165	310		A01A
A	A020T478ZA75	80	11	950	730	30	30	165	160	11/14,5	A01
H	A020T478HA80	80	10	770	545	--	--	35	130	10/13	A08
	A020T316ZB76	80	6/P/5	950	950	30	30	205	197		A01A
A	A020T316ZB75	80	6	950	950	30	30	205	102	6/17	A01
H	A020T316HB80	80	5	750	750	--	--	140	85	5/17	A08
	A020T244ZC76	80	9/7	950	950	30	30	145	272		A01A
A	A020T244ZC75	80	9	950	950	30	30	145	153	9/17	A01
H	A020T244HC80	80	7	750	750	--	--	63	119	7/17	A08
	A020T320ZB76	80	7/P/7	956	956	30	30	220	244		A01A
A	A020T320ZB75	80	7	956	956	30	30	220	112	7/16	A01
H	A020T320HB80	80	7	770	770	--	--	120	112	7/16	A08
	A020T316ZA76	80	6/P/5	950	950	30	30		207	6/17+5/17+P/20	A01A.17
A	A020T316ZA75	80	6	950	950	30	30		102	6/17	A01.17
H	A020T316HA80										
	A020T320ZA76	80	7/P/7	956	956	30	30	220	244		A01A.17
A	A020T320ZA75	80	7	956	956	30	30	220	112	7/16	A01.17
H	A020T320HA80	80	7	770	770	--	--	220	112	7/16	A08
	A020T276ZA75	80	9/5	792	622	30	30	159	186	2/13+7/10+5/18	A01B
	A020T358ZA75	80	5/3	950	950	30	30	32	174	5/18+3/28	A01B
	A020T390ZA70	90	11	745	745	--	--	65	220	11/20	A08R
	A020T380ZA70	94	11	745	745	--	--	94	198	11/18	A08R
	A020T354ZA70	94	14	750	750	--	--	100	252	14/18	A08R
	F020T302ZA76	80	3/P/2	950	950	30	30	195	160		F01A
A	F020T302ZA75	80	3	950	950	30	30	195	84	3/26	F01
H	F020T302HA80	80	2	775	775	--	--	100	56	2/26	F08
	F020T458ZA76	80	3/P/3	950	950	30	30	205	185		F01A
A	F020T458ZA75	80	3	950	950	30	30	205	84	3/26	F01
H	F020T458HA80	80	3	775	775	--	--	89	81	3/25	F08
	F020T598ZA70	90	6	740	740	--	--		183	3/30+3/27	F08R
	F020T590ZA70	93	6	750	750	--	--	78	214	4/33+2/35	F08R
	F020T536ZA70	93	5	765	765	--	--	113	165	5/31	F08R

BESTELNR N° COMMANDE ORDER NR BESTELNR	BR LRG WID BR	BLADEN LAMES LEAVES BLATT.	B	C	D1	D2	PH FL FA SP	PAK EP TH PAK	DETAIL	MOD	OPMERKINGEN REMARKS BEMERKUNGEN
---	------------------------	-------------------------------------	---	---	----	----	----------------------	------------------------	--------	-----	---------------------------------------

SERIE : -

2228

voor-avant-front-Vorne

A020T321ZA75	80	10/P	860	860	25	25	155	140	10/13+P/10	A01	
A020T463ZA75	80	10/P	860	860	25	25	138	142	10/13+P/12	A01	
A020T421ZA75	90	12	765	900	30	25	210	144	12/12	A01	
A020T419ZA75	90	12	900	765	25	25	120	144	12/12	A01	
A020T311ZB75	90	9	900	900	25	25	135	117	9/13	A01	
A020T323ZA75	90	12	900	900	25	25	90	175	7/15+5/14	A01	
A020T235ZB75	90	12	900	900	25	25	200	122	2/11+10/10	A01	
A020T239ZB75	90	13	900	900	25	25	130	156	13/12	A01	
A020T485ZA75	90	14	900	900	25	25	65	198	2/15+12/14	A01	
A020T235ZA75	90	12	900	900	25	25	200	122	2/11+10/10	A01.16	Vervangen
A020T281ZA75	80	10/P	860	860	25	25	155	140	10/13+P/10	A01.17	
A020T457ZA75	80	11/2	860	860	25	25	184	151	1/14+10/10,5+2/1	A01B	
F020T303ZA75	90	3	900	900	25	25	163	72	3/21	F01	
F020T369ZA75	90	4	900	900	25	25	150	96	4/21	F01	
F020T299ZA75	90	4	900	900	25	25	166	90	1/21+3/19	F01	
F020T363ZA75	80	3	860	860	25	25	145	75	3/23	F01.70	
F020T477ZA75	80	4	860	860	25	25	151	96	4/22	F01.70	
F020T553ZA75	80	4	860	860	25	25	147	96	4/22	F01.70	
F020T617ZA75	90	2	750	570	30	30	24	35	2/13	F01.70	
F020T567ZA75	90	2	750	570	30	30	-15	36	2/14	F01.70	
F020T561ZA75	90	2/P	800	850	30	30	-70	50	1/16+1/18+P/13	F01.70	
F020T297ZA75	90	3	900	900	25	25	160	75	3/22	F01.70	

BESTELNR N° COMMANDE ORDER NR BESTELLNR	BR LRG WID BR	BLADEN LAMES LEAVES BLATT.	B	C	D1	D2	PH FL FA SP	PAK EP TH PAK	DETAIL	MOD	OPMERKINGEN REMARKS BEMERKUNGEN
--	------------------------	-------------------------------------	---	---	----	----	----------------------	------------------------	--------	-----	---------------------------------------

SERIE : -

2228

achter-arrière-rear-Hinten

A	A020T400ZA76	80	9/P/9	725	950	30	30	145	268		A01A	
	A020T400ZA75	80	9	725	950	30	30	145	131	9/14,5	A01	
H	A020T400HA80	80	9	525	750	--	--	40	113	9/12,5	A08	
A	A020T540ZA76	80	13/P/10	950	725	30	30	100	309		A01A	
	A020T540ZA75	80	13	950	725	30	30	100	169	13/13	A01	
H	A020T540HA80	80	10	770	545	--	--	11	120	10/12	A08	
A	A020T316ZB76	80	6/P/5	950	950	30	30	205	197		A01A	
	A020T316ZB75	80	6	950	950	30	30	205	102	6/17	A01	
H	A020T316HB80	80	5	750	750	--	--	140	85	5/17	A08	
A	A020T244ZC76	80	9/7	950	950	30	30	145	272		A01A	
	A020T244ZC75	80	9	950	950	30	30	145	153	9/17	A01	
H	A020T244HC80	80	7	750	750	--	--	63	119	7/17	A08	
A	A020T320ZB76	80	7/P/7	956	956	30	30	220	244		A01A	
	A020T320ZB75	80	7	956	956	30	30	220	112	7/16	A01	
H	A020T320HB80	80	7	770	770	--	--	120	112	7/16	A08	
A	A020T270ZC76	100	8/P/6	900	900	30	30	195	212		A01A	
	A020T270ZC75	100	8	900	900	30	30	195	115	3/15+5/14	A01	
H	A020T270HC80	100	6	750	750	--	--	90	84	6/14	A08	
A	A020T310ZC76	100	9/P/7	900	900	30	30	170	242		A01A	
	A020T310ZC75	100	9	900	900	30	30	170	130	4/15+5/14	A01	
H	A020T310HC80	100	7	770	770	--	--	70	98	7/14	A08	
A	A020T242ZC76	100	11/P/10	900	900	30	30	190	303		A01A	
	A020T242ZC75	100	11	900	900	30	30	190	160	6/15+5/14	A01	
H	A020T242HC80	100	10	750	750	--	--	67	130	10/13	A08	
A	A020T316ZA76	80	6/P/5	950	950	30	30		207	6/17+5/17+P/20	A01A.17	
	A020T316ZA75	80	6	950	950	30	30		102	6/17	A01.17	
H	A020T316HA80											
A	A020T320ZA76	80	7/P/7	956	956	30	30	220	244		A01A.17	
	A020T320ZA75	80	7	956	956	30	30	220	112	7/16	A01.17	
H	A020T320HA80	80	7	770	770	--	--	220	112	7/16	A08	
A	A020T310ZB76	100	9/P/7	900	900	30	30	170	242		A01A.17	
	A020T310ZB75	100	9	900	900	30	30	170	130	4/15+5/14	A01.17	
H	A020T310HB80	100	7	770	770	--	--	70	98	7/14	A08	
A	A020T242ZB76	100	11/P/10	900	900	30	30	190	303		A01A.17	Vervangen
	A020T242ZB75	100	11	900	900	30	30	190	160	5/15+1/14+1/15+4	A01.17	Vervangen
H	A020T242HB80	100	10	750	750	--	--	67	130	10/13	A08	
	A020T276ZA75	80	9/5	792	622	30	30	159	186	2/13+7/10+5/18	A01B	
	A020T358ZA75	80	5/3	950	950	30	30	32	174	5/18+3/28	A01B	
A	A020T402ZA75	100	7/P/4	620	780	30	30	120	157	1/13+1/12+5/11+	A01B	
	A020T402ZA85	100	7	620	780	30	30	120	80	1/13+1/12+5/11	A01	
	A020T452ZA75	100	7/4	780	620	30	30	120	148	7/12+4/16	A01B	
	A020T356ZA75	100	7/P/4	620	780	30	30	149	157	1/13+1/12+5/11+	A01B.17	

BESTELNR N° COMMANDE ORDER NR BESTELLNR	BR LRG WID BR	BLADEN LAMES LEAVES BLATT.	B	C	D1	D2	PH FL FA SP	PAK EP TH PAK	DETAIL	MOD	OPMERKINGEN REMARQUES REMARKS BEMERKUNGEN
--	------------------------	-------------------------------------	---	---	----	----	----------------------	------------------------	--------	-----	--

SERIE : -

2228

	A020T788ZA70	94	11	750	750	--	--	80	193	6/18+5/17	A08R
	A020T514ZA70	94	11	925	925	--	--	130	189	2/18+9/17	A08R
	F020T508ZA75	100	6	620	780	30	30	85	144	6/22	F01
	F020T302ZA76	80	3/P/2	950	950	30	30	195	160		F01A
A	F020T302ZA75	80	3	950	950	30	30	195	84	3/26	F01
H	F020T302HA80	80	2	775	775	--	--	100	56	2/26	F08
	F020T458ZA76	80	3/P/3	950	950	30	30	205	185		F01A
A	F020T458ZA75	80	3	950	950	30	30	205	84	3/26	F01
H	F020T458HA80	80	3	775	775	--	--	89	81	3/25	F08
	F020T296ZA76	100	3/P/P/2	900	900	30	30	200	218		F01A
A	F020T296ZA75	100	3	900	900	30	30	200	84	3/25	F01
H	F020T296HA80	100	2	740	740	--	--	110	54	2/24	F08
	F020T456ZA76	100	3/P/3	900	900	30	30	146	179		F01A
A	F020T456ZA75	100	3	900	900	30	30	146	84	3/25	F01
H	F020T456HA80	100	3	740	740	--	--	90	81	3/24	F08
	F020T304ZA70	93	5	925	925	--	--	127	151	1/27+4/26	F08R
	F020T668ZA70	94	5	770	770	--	--	82	190	5/36	F08R

BESTELNR N° COMMANDE ORDER NR BESTELNR	BR LRG WID BR	BLADEN LAMES LEAVES BLATT.	B	C	D1	D2	PH FL FA SP	PAK EP TH PAK	DETAIL	MOD	OPMERKINGEN REMARQUES REMARKS BEMERKUNGEN
---	------------------------	-------------------------------------	---	---	----	----	----------------------	------------------------	--------	-----	--

SERIE : -**2233****voor-avant-front-Vorne**

A020T421ZA75	90	12	765	900	30	25	210	144	12/12	A01	
A020T419ZA75	90	12	900	765	25	25	120	144	12/12	A01	
A020T311ZB75	90	9	900	900	25	25	135	117	9/13	A01	
A020T235ZB75	90	12	900	900	25	25	200	122	2/11+10/10	A01	
A020T239ZB75	90	13	900	900	25	25	130	156	13/12	A01	
A020T235ZA75	90	12	900	900	25	25	200	122	2/11+10/10	A01.16	Vervangen
F020T605ZA75	90	5	765	900	30	25	215	115	5/20	F01	
F020T601ZA75	90	5	900	765	25	25	123	115	5/20	F01	
F020T303ZA75	90	3	900	900	25	25	163	72	3/21	F01	
F020T369ZA75	90	4	900	900	25	25	150	96	4/21	F01	
F020T299ZA75	90	4	900	900	25	25	166	90	1/21+3/19	F01	
F020T561ZA75	90	2/P	800	850	30	30	-70	50	1/16+1/18+P/13	F01.70	
F020T297ZA75	90	3	900	900	25	25	160	75	3/22	F01.70	

achter-arrière-rear-Hinten

A	A020T402ZA75	100	7/P/4	620	780	30	30	120	157	1/13+1/12+5/11+	A01B	
	A020T402ZA85	100	7	620	780	30	30	120	80	1/13+1/12+5/11	A01	
	A020T452ZA75	100	7/4	780	620	30	30	120	148	7/12+4/16	A01B	
	A020T788ZA70	94	11	750	750	--	--	80	193	6/18+5/17	A08R	
	A020T514ZA70	94	11	925	925	--	--	130	189	2/18+9/17	A08R	
	F020T508ZA75	100	6	620	780	30	30	85	144	6/22	F01	
	F020T304ZA70	93	5	925	925	--	--	127	151	1/27+4/26	F08R	
	F020T668ZA70	94	5	770	770	--	--	82	190	5/36	F08R	

BESTELNR N° COMMANDE ORDER NR BESTELNR	BR LRG WID BR	BLADEN LAMES LEAVES BLATT.	B	C	D1	D2	PH FL FA SP	PAK EP TH PAK	DETAIL	MOD	OPMERKINGEN REMARQUES REMARKS BEMERKUNGEN
---	------------------------	-------------------------------------	---	---	----	----	----------------------	------------------------	--------	-----	--

SERIE : -**2235****voor-avant-front-Vorne**

A020T311ZB75	90	9	900	900	25	25	135	117	9/13	A01	
A020T235ZB75	90	12	900	900	25	25	200	122	2/11+10/10	A01	
A020T239ZB75	90	13	900	900	25	25	130	156	13/12	A01	
A020T235ZA75	90	12	900	900	25	25	200	122	2/11+10/10	A01.16	Vervangen
F020T605ZA75	90	5	765	900	30	25	215	115	5/20	F01	
F020T601ZA75	90	5	900	765	25	25	123	115	5/20	F01	
F020T303ZA75	90	3	900	900	25	25	163	72	3/21	F01	
F020T611ZA75	90	3	900	900	25	25	108	78	3/23.5	F01	
F020T299ZA75	90	4	900	900	25	25	166	90	1/21+3/19	F01	
F020T369ZA75	90	4	900	900	25	25	150	96	4/21	F01	
F020T503ZA75	90	4	900	900	25	25	132	100	4/22	F01	
F020T567ZA75	90	2	750	570	30	30	-15	36	2/14	F01.70	
F020T561ZA75	90	2/P	800	850	30	30	-70	50	1/16+1/18+P/13	F01.70	

achter-arrière-rear-Hinten

A020T452ZA75	100	7/4	780	620	30	30	120	148	7/12+4/16	A01B	
A020T788ZA70	94	11	750	750	--	--	80	193	6/18+5/17	A08R	
A020T514ZA70	94	11	925	925	--	--	130	189	2/18+9/17	A08R	
F020T508ZA75	100	6	620	780	30	30	85	144	6/22	F01	
F020T304ZA70	93	5	925	925	--	--	127	151	1/27+4/26	F08R	
F020T668ZA70	94	5	770	770	--	--	82	190	5/36	F08R	

BESTELNR N° COMMANDE ORDER NR BESTELNR	BR LRG WID BR	BLADEN LAMES LEAVES BLATT.	B	C	D1	D2	PH FL FA SP	PAK EP TH PAK	DETAIL	MOD	OPMERKINGEN REMARQUES REMARKS BEMERKUNGEN
---	------------------------	-------------------------------------	---	---	----	----	----------------------	------------------------	--------	-----	--

SERIE : -**2236****voor-avant-front-Vorne**

A020T421ZA75	90	12	765	900	30	25	210	144	12/12	A01
A020T419ZA75	90	12	900	765	25	25	120	144	12/12	A01
A020T311ZB75	90	9	900	900	25	25	135	117	9/13	A01
A020T235ZB75	90	12	900	900	25	25	200	122	2/11+10/10	A01
A020T239ZB75	90	13	900	900	25	25	130	156	13/12	A01
A020T235ZA75	90	12	900	900	25	25	200	122	2/11+10/10	A01.16 Vervangen
F020T303ZA75	90	3	900	900	25	25	163	72	3/21	F01
F020T369ZA75	90	4	900	900	25	25	150	96	4/21	F01
F020T299ZA75	90	4	900	900	25	25	166	90	1/21+3/19	F01
F020T297ZA75	90	3	900	900	25	25	160	75	3/22	F01.70

achter-arrière-rear-Hinten

A020T402ZA75	100	7/P/4	620	780	30	30	120	157	1/13+1/12+5/11+	A01B
A020T402ZA85	100	7	620	780	30	30	120	80	1/13+1/12+5/11	A01
A020T452ZA75	100	7/4	780	620	30	30	120	148	7/12+4/16	A01B
A020T788ZA70	94	11	750	750	--	--	80	193	6/18+5/17	A08R
A020T514ZA70	94	11	925	925	--	--	130	189	2/18+9/17	A08R
F020T508ZA75	100	6	620	780	30	30	85	144	6/22	F01
F020T304ZA70	93	5	925	925	--	--	127	151	1/27+4/26	F08R
F020T668ZA70	94	5	770	770	--	--	82	190	5/36	F08R

BESTELNR N° COMMANDE ORDER NR BESTELNR	BR LRG WID BR	BLADEN LAMES LEAVES BLATT.	B	C	D1	D2	PH FL FA SP	PAK EP TH PAK	DETAIL	MOD	OPMERKINGEN REMARQUES REMARKS BEMERKUNGEN
---	------------------------	-------------------------------------	---	---	----	----	----------------------	------------------------	--------	-----	--

SERIE : -

2238

voor-avant-front-Vorne

A020T421ZA75	90	12	765	900	30	25	210	144	12/12	A01
A020T419ZA75	90	12	900	765	25	25	120	144	12/12	A01
A020T311ZB75	90	9	900	900	25	25	135	117	9/13	A01
A020T235ZB75	90	12	900	900	25	25	200	122	2/11+10/10	A01
A020T239ZB75	90	13	900	900	25	25	130	156	13/12	A01
A020T235ZA75	90	12	900	900	25	25	200	122	2/11+10/10	A01.16 Vervangen
F020T303ZA75	90	3	900	900	25	25	163	72	3/21	F01
F020T369ZA75	90	4	900	900	25	25	150	96	4/21	F01
F020T299ZA75	90	4	900	900	25	25	166	90	1/21+3/19	F01
F020T297ZA75	90	3	900	900	25	25	160	75	3/22	F01.70

achter-arrière-rear-Hinten

A	A020T402ZA75	100	7/P/4	620	780	30	30	120	157	1/13+1/12+5/11+	A01B
	A020T402ZA85	100	7	620	780	30	30	120	80	1/13+1/12+5/11	A01
	A020T452ZA75	100	7/4	780	620	30	30	120	148	7/12+4/16	A01B
	A020T788ZA70	94	11	750	750	--	--	80	193	6/18+5/17	A08R
	A020T514ZA70	94	11	925	925	--	--	130	189	2/18+9/17	A08R
	F020T508ZA75	100	6	620	780	30	30	85	144	6/22	F01
	F020T304ZA70	93	5	925	925	--	--	127	151	1/27+4/26	F08R

BESTELNR N° COMMANDE ORDER NR BESTELNR	BR LRG WID BR	BLADEN LAMES LEAVES BLATT.	B	C	D1	D2	PH FL FA SP	PAK EP TH PAK	DETAIL	MOD	OPMERKINGEN REMARKS REMARKS BEMERKUNGEN
---	------------------------	-------------------------------------	---	---	----	----	----------------------	------------------------	--------	-----	--

SERIE : -**2244****voor-avant-front-Vorne**

A020T311ZB75	90	9	900	900	25	25	135	117	9/13	A01	
A020T235ZB75	90	12	900	900	25	25	200	122	2/11+10/10	A01	
A020T239ZB75	90	13	900	900	25	25	130	156	13/12	A01	
A020T235ZA75	90	12	900	900	25	25	200	122	2/11+10/10	A01.16	Vervangen
F020T605ZA75	90	5	765	900	30	25	215	115	5/20	F01	
F020T601ZA75	90	5	900	765	25	25	123	115	5/20	F01	
F020T303ZA75	90	3	900	900	25	25	163	72	3/21	F01	
F020T299ZA75	90	4	900	900	25	25	166	90	1/21+3/19	F01	
F020T369ZA75	90	4	900	900	25	25	150	96	4/21	F01	

achter-arrière-rear-Hinten

A020T452ZA75	100	7/4	780	620	30	30	120	148	7/12+4/16	A01B	
A020T788ZA70	94	11	750	750	--	--	80	193	6/18+5/17	A08R	
A020T514ZA70	94	11	925	925	--	--	130	189	2/18+9/17	A08R	
F020T508ZA75	100	6	620	780	30	30	85	144	6/22	F01	
F020T304ZA70	93	5	925	925	--	--	127	151	1/27+4/26	F08R	

2420**voor-avant-front-Vorne**

A020T511ZA75	80	11	860	860	S22	S22	118	149	11/13.5	A01	
A020T677ZA75	80	14	860	860	S22	S22	176	147	14/10.5	A01	Silentbloc
F020T499ZA75	80	3	860	860	S22	S22	125	81	3/24	F01	
F020T513ZA75	90	2/P	750	650	S22	S22	-14	62	2/13+P/20	F01.70	Silentbloc

achter-arrière-rear-Hinten

F020T676ZA75	80	6	790	620	S22	S22	73	156	6/23	F01	Silentbloc
--------------	----	---	-----	-----	-----	-----	----	-----	------	-----	------------

BESTELNR N° COMMANDE ORDER NR BESTELNR	BR LRG WID BR	BLADEN LAMES LEAVES BLATT.	B	C	D1	D2	PH FL FA SP	PAK EP TH PAK	DETAIL	MOD	OPMERKINGEN REMARQUES REMARKS BEMERKUNGEN
---	------------------------	-------------------------------------	---	---	----	----	----------------------	------------------------	--------	-----	--

SERIE : -**2422****voor-avant-front-Vorne**

A020T511ZA75	80	11	860	860	S22	S22	118	149	11/13.5	A01	
A020T321ZA75	80	10/P	860	860	25	25	155	140	10/13+P/10	A01	
A020T463ZA75	80	10/P	860	860	25	25	138	142	10/13+P/12	A01	
A020T677ZA75	80	14	860	860	S22	S22	176	147	14/10.5	A01	Silentbloc
A020T311ZB75	90	9	900	900	25	25	135	117	9/13	A01	
A020T333ZA75	90	10	900	900	25	25	80	145	5/15+5/14	A01	
A020T323ZA75	90	12	900	900	25	25	90	175	7/15+5/14	A01	
A020T239ZB75	90	13	900	900	25	25	130	156	13/12	A01	
A020T485ZA75	90	14	900	900	25	25	65	198	2/15+12/14	A01	
A020T243ZB75	90	10	900	900	25	25	80	145	5/15+5/14	A01.16	Vervangen
A020T281ZA75	80	10/P	860	860	25	25	155	140	10/13+P/10	A01.17	
A020T455ZA75	80	9/2/P	860	860	25	25	157	142	9/11,5+2/15+P/8	A01B	
A020T651ZA75	80	11/2	860	860	S22	S22	164	150	11/10.5+2/17	A01B	Silentbloc
A020T457ZA75	80	11/2	860	860	25	25	184	151	1/14+10/10,5+2/1	A01B	
F020T499ZA75	80	3	860	860	S22	S22	125	81	3/24	F01	
F020T501ZA75	80	4	860	860	S22	S22	115	100	4/22	F01	
F020T515ZA75	80	4	860	860	S22	S22	128	100	4/22	F01	
F020T303ZA75	90	3	900	900	25	25	163	72	3/21	F01	
F020T299ZA75	90	4	900	900	25	25	166	90	1/21+3/19	F01	
F020T363ZA75	80	3	860	860	25	25	145	75	3/23	F01.70	
F020T477ZA75	80	4	860	860	25	25	151	96	4/22	F01.70	
F020T553ZA75	80	4	860	860	25	25	147	96	4/22	F01.70	
F020T617ZA75	90	2	750	570	30	30	24	35	2/13	F01.70	
F020T567ZA75	90	2	750	570	30	30	-15	36	2/14	F01.70	
F020T513ZA75	90	2/P	750	650	S22	S22	-14	62	2/13+P/20	F01.70	Silentbloc
F020T603ZA75	90	2/P	800	850	30	30	-40	51	2/17+P/14	F01.70	

BESTELNR N° COMMANDE ORDER NR BESTELLNR	BR LRG WID BR	BLADEN LAMES LEAVES BLATT.	B	C	D1	D2	PH FL FA SP	PAK EP TH PAK	DETAIL	MOD	OPMERKINGEN REMARKS BEMERKUNGEN
--	------------------------	-------------------------------------	---	---	----	----	----------------------	------------------------	--------	-----	---------------------------------------

SERIE : -**2422****achter-arrière-rear-Hinten**

A	A020T400ZA76	80	9/P/9	725	950	30	30	145	268		A01A	
	A020T400ZA75	80	9	725	950	30	30	145	131	9/14,5	A01	
H	A020T400HA80	80	9	525	750	--	--	40	113	9/12,5	A08	
A	A020T540ZA76	80	13/P/10	950	725	30	30	100	309		A01A	
	A020T540ZA75	80	13	950	725	30	30	100	169	13/13	A01	
H	A020T540HA80	80	10	770	545	--	--	11	120	10/12	A08	
A	A020T316ZB76	80	6/P/5	950	950	30	30	205	197		A01A	
	A020T316ZB75	80	6	950	950	30	30	205	102	6/17	A01	
H	A020T316HB80	80	5	750	750	--	--	140	85	5/17	A08	
A	A020T244ZC76	80	9/7	950	950	30	30	145	272		A01A	
	A020T244ZC75	80	9	950	950	30	30	145	153	9/17	A01	
H	A020T244HC80	80	7	750	750	--	--	63	119	7/17	A08	
A	A020T320ZB76	80	7/P/7	956	956	30	30	220	244		A01A	
	A020T320ZB75	80	7	956	956	30	30	220	112	7/16	A01	
H	A020T320HB80	80	7	770	770	--	--	120	112	7/16	A08	
A	A020T270ZC76	100	8/P/6	900	900	30	30	195	212		A01A	
	A020T270ZC75	100	8	900	900	30	30	195	115	3/15+5/14	A01	
H	A020T270HC80	100	6	750	750	--	--	90	84	6/14	A08	
A	A020T310ZC76	100	9/P/7	900	900	30	30	170	242		A01A	
	A020T310ZC75	100	9	900	900	30	30	170	130	4/15+5/14	A01	
H	A020T310HC80	100	7	770	770	--	--	70	98	7/14	A08	
A	A020T242ZC76	100	11/P/10	900	900	30	30	190	303		A01A	
	A020T242ZC75	100	11	900	900	30	30	190	160	6/15+5/14	A01	
H	A020T242HC80	100	10	750	750	--	--	67	130	10/13	A08	
A	A020T316ZA76	80	6/P/5	950	950	30	30		207	6/17+5/17+P/20	A01A.17	
	A020T316ZA75	80	6	950	950	30	30		102	6/17	A01.17	
H	A020T316HA80											
A	A020T320ZA76	80	7/P/7	956	956	30	30	220	244		A01A.17	
	A020T320ZA75	80	7	956	956	30	30	220	112	7/16	A01.17	
H	A020T320HA80	80	7	770	770	--	--	220	112	7/16	A08	
A	A020T310ZB76	100	9/P/7	900	900	30	30	170	242		A01A.17	
	A020T310ZB75	100	9	900	900	30	30	170	130	4/15+5/14	A01.17	
H	A020T310HB80	100	7	770	770	--	--	70	98	7/14	A08	
A	A020T242ZB76	100	11/P/10	900	900	30	30	190	303		A01A.17	Vervangen
	A020T242ZB75	100	11	900	900	30	30	190	160	5/15+1/14+1/15+4	A01.17	Vervangen
H	A020T242HB80	100	10	750	750	--	--	67	130	10/13	A08	
	A020T358ZA75	80	5/3	950	950	30	30	32	174	5/18+3/28	A01B	
	A020T452ZA75	100	7/4	780	620	30	30	120	148	7/12+4/16	A01B	
	A020T390ZA70	90	11	745	745	--	--	65	220	11/20	A08R	
	A020T354ZA70	94	14	750	750	--	--	100	252	14/18	A08R	
	F020T676ZA75	80	6	790	620	S22	S22	73	156	6/23	F01	Silentbloc

BESTELNR N° COMMANDE ORDER NR BESTELNR	BR LRG WID BR	BLADEN LAMES LEAVES BLATT.	B	C	D1	D2	PH FL FA SP	PAK EP TH PAK	DETAIL	MOD	OPMERKINGEN REMARKS REMARKS BEMERKUNGEN
---	------------------------	-------------------------------------	---	---	----	----	----------------------	------------------------	--------	-----	--

SERIE : -**2422**

	F020T508ZA75	100	6	620	780	30	30	85	144	6/22	F01
	F020T302ZA76	80	3/P/2	950	950	30	30	195	160		F01A
A	F020T302ZA75	80	3	950	950	30	30	195	84	3/26	F01
H	F020T302HA80	80	2	775	775	--	--	100	56	2/26	F08
	F020T458ZA76	80	3/P/3	950	950	30	30	205	185		F01A
A	F020T458ZA75	80	3	950	950	30	30	205	84	3/26	F01
H	F020T458HA80	80	3	775	775	--	--	89	81	3/25	F08
	F020T296ZA76	100	3/P/P/2	900	900	30	30	200	218		F01A
A	F020T296ZA75	100	3	900	900	30	30	200	84	3/25	F01
H	F020T296HA80	100	2	740	740	--	--	110	54	2/24	F08
	F020T456ZA76	100	3/P/3	900	900	30	30	146	179		F01A
A	F020T456ZA75	100	3	900	900	30	30	146	84	3/25	F01
H	F020T456HA80	100	3	740	740	--	--	90	81	3/24	F08
	F020T590ZA70	93	6	750	750	--	--	78	214	4/33+2/35	F08R

2426**voor-avant-front-Vorne**

	A020T511ZA75	80	11	860	860	S22	S22	118	149	11/13.5	A01
	A020T677ZA75	80	14	860	860	S22	S22	176	147	14/10.5	A01 Silentbloc
	F020T499ZA75	80	3	860	860	S22	S22	125	81	3/24	F01
	F020T515ZA75	80	4	860	860	S22	S22	128	100	4/22	F01
	F020T513ZA75	90	2/P	750	650	S22	S22	-14	62	2/13+P/20	F01.70 Silentbloc

achter-arrière-rear-Hinten

	A020T390ZA70	90	11	745	745	--	--	65	220	11/20	A08R
	A020T354ZA70	94	14	750	750	--	--	100	252	14/18	A08R
	F020T590ZA70	93	6	750	750	--	--	78	214	4/33+2/35	F08R
	F020T804ZA70	94	3	750	750	--	--	75	135	3/43	F08R

BESTELNR N° COMMANDE ORDER NR BESTELNR	BR LRG WID BR	BLADEN LAMES LEAVES BLATT.	B	C	D1	D2	PH FL FA SP	PAK EP TH PAK	DETAIL	MOD	OPMERKINGEN REMARKS REMARKS BEMERKUNGEN
---	------------------------	-------------------------------------	---	---	----	----	----------------------	------------------------	--------	-----	--

SERIE : -**2428****voor-avant-front-Vorne**

A020T323ZA75	90	12	900	900	25	25	90	175	7/15+5/14	A01	
A020T235ZB75	90	12	900	900	25	25	200	122	2/11+10/10	A01	
A020T239ZB75	90	13	900	900	25	25	130	156	13/12	A01	
A020T485ZA75	90	14	900	900	25	25	65	198	2/15+12/14	A01	
A020T235ZA75	90	12	900	900	25	25	200	122	2/11+10/10	A01.16	Vervangen
F020T303ZA75	90	3	900	900	25	25	163	72	3/21	F01	
F020T503ZA75	90	4	900	900	25	25	132	100	4/22	F01	
F020T369ZA75	90	4	900	900	25	25	150	96	4/21	F01	
F020T561ZA75	90	2/P	800	850	30	30	-70	50	1/16+1/18+P/13	F01.70	
F020T297ZA75	90	3	900	900	25	25	160	75	3/22	F01.70	

achter-arrière-rear-Hinten

A	A020T270ZC76	100	8/P/6	900	900	30	30	195	212		A01A	
H	A020T270ZC75	100	8	900	900	30	30	195	115	3/15+5/14	A01	
H	A020T270HC80	100	6	750	750	--	--	90	84	6/14	A08	
A	A020T310ZC76	100	9/P/7	900	900	30	30	170	242		A01A	
H	A020T310ZC75	100	9	900	900	30	30	170	130	4/15+5/14	A01	
H	A020T310HC80	100	7	770	770	--	--	70	98	7/14	A08	
A	A020T242ZC76	100	11/P/10	900	900	30	30	190	303		A01A	
H	A020T242ZC75	100	11	900	900	30	30	190	160	6/15+5/14	A01	
H	A020T242HC80	100	10	750	750	--	--	67	130	10/13	A08	
A	A020T310ZB76	100	9/P/7	900	900	30	30	170	242		A01A.17	
H	A020T310ZB75	100	9	900	900	30	30	170	130	4/15+5/14	A01.17	
H	A020T310HB80	100	7	770	770	--	--	70	98	7/14	A08	
A	A020T242ZB76	100	11/P/10	900	900	30	30	190	303		A01A.17	Vervangen
H	A020T242ZB75	100	11	900	900	30	30	190	160	5/15+1/14+1/15+4	A01.17	Vervangen
H	A020T242HB80	100	10	750	750	--	--	67	130	10/13	A08	
A	F020T296ZA76	100	3/P/P/2	900	900	30	30	200	218		F01A	
H	F020T296ZA75	100	3	900	900	30	30	200	84	3/25	F01	
H	F020T296HA80	100	2	740	740	--	--	110	54	2/24	F08	
A	F020T456ZA76	100	3/P/3	900	900	30	30	146	179		F01A	
H	F020T456ZA75	100	3	900	900	30	30	146	84	3/25	F01	
H	F020T456HA80	100	3	740	740	--	--	90	81	3/24	F08	

BESTELNR N° COMMANDE ORDER NR BESTELNR	BR LRG WID BR	BLADEN LAMES LEAVES BLATT.	B	C	D1	D2	PH FL FA SP	PAK EP TH PAK	DETAIL	MOD	OPMERKINGEN REMARQUES REMARKS BEMERKUNGEN
---	------------------------	-------------------------------------	---	---	----	----	----------------------	------------------------	--------	-----	--

SERIE : -**2429****voor-avant-front-Vorne**

A020T235ZB75	90	12	900	900	25	25	200	122	2/11+10/10	A01	
A020T239ZB75	90	13	900	900	25	25	130	156	13/12	A01	
A020T235ZA75	90	12	900	900	25	25	200	122	2/11+10/10	A01.16	Vervangen
F020T303ZA75	90	3	900	900	25	25	163	72	3/21	F01	
F020T611ZA75	90	3	900	900	25	25	108	78	3/23.5	F01	
F020T503ZA75	90	4	900	900	25	25	132	100	4/22	F01	
F020T299ZA75	90	4	900	900	25	25	166	90	1/21+3/19	F01	
F020T369ZA75	90	4	900	900	25	25	150	96	4/21	F01	
F020T425ZA75	90	2	750	570	30	30	-12	37	2/14	F01.70	
F020T453ZA75	90	2	750	570	30	30	28	35	2/13	F01.70	
F020T617ZA75	90	2	750	570	30	30	24	35	2/13	F01.70	
F020T567ZA75	90	2	750	570	30	30	-15	36	2/14	F01.70	
F020T603ZA75	90	2/P	800	850	30	30	-40	51	2/17+P/14	F01.70	
F020T561ZA75	90	2/P	800	850	30	30	-70	50	1/16+1/18+P/13	F01.70	

achter-arrière-rear-Hinten

A020T720ZA75	100	11/6	780	620	30	30	35	228	11/12+6/16	A01B	
A020T788ZA70	94	11	750	750	--	--	80	193	6/18+5/17	A08R	
A020T708ZA70	104	11	815	815	--	--	120	187	11/17	A08R	
F020T508ZA75	100	6	620	780	30	30	85	144	6/22	F01	
F020T308ZA76	100	3/P/1	950	950	30	30	132	122		F01A	
A F020T308ZA75	100	3	950	950	30	30	132	84	3/26	F01	
H F020T308HA80	100	1	760	760	--	--	130	22	1/22	F08	
F020T626ZA76	100	3/P/2	950	950	30	30	168	143		F01A	
A F020T626ZA75	100	3	950	950	30	30	168	87	3/26	F01	
H F020T626HA80	100	2	765	765	--	--	108	48	2/21	F08	
F020T304ZA70	93	5	925	925	--	--	127	151	1/27+4/26	F08R	
F020T696ZA70	93	5	925	925	--	--	155	151	1/27+4/26	F08R	
F020T668ZA70	94	5	770	770	--	--	82	190	5/36	F08R	

BESTELNR N° COMMANDE ORDER NR BESTELNR	BR LRG WID BR	BLADEN LAMES LEAVES BLATT.	B	C	D1	D2	PH FL FA SP	PAK EP TH PAK	DETAIL	MOD	OPMERKINGEN REMARQUES REMARKS BEMERKUNGEN
---	------------------------	-------------------------------------	---	---	----	----	----------------------	------------------------	--------	-----	--

SERIE : -

2431

voor-avant-front-Vorne

A020T511ZA75	80	11	860	860	S22	S22	118	149	11/13.5	A01	
A020T677ZA75	80	14	860	860	S22	S22	176	147	14/10.5	A01	Silentbloc
F020T499ZA75	80	3	860	860	S22	S22	125	81	3/24	F01	
F020T583ZA75	80	4	860	860	S22	S22	143	98	1/20+3/22	F01	
F020T515ZA75	80	4	860	860	S22	S22	128	100	4/22	F01	

achter-arrière-rear-Hinten

	A020T652ZA76	80	7/P/7	950	950	S22	S22	177	244		A01A	Silentbloc
A	A020T652ZA75	80	7	950	950	S22	S22	177	112	7/16	A01	Silentbloc
H	A020T652HA80	80	7	775	775	--	--	43	112	7/16	A08	
	A020T654ZA76	80	9/7	950	950	S22	S22	126	272		A01A	Silentbloc
A	A020T654ZA75	80	9	950	950	S22	S22	125	153	9/17	A01	Silentbloc
H	A020T654HA80	80	7	750	750	--	--	0	119	7/17	A08	
	F020T586ZA76	80	4/4	950	725	S22	S22	140	214		F01A	Silentbloc
A	F020T586ZA75	80	4	950	725	S22	S22	140	118	4/24	F01	Silentbloc
H	F020T586HA80	80	4	770	550	--	--	45	96	4/21	F08	
	F020T570ZA76	80	3/3	950	950	S22	S22	180	171		F01A	Silentbloc
A	F020T570ZA75	80	3	950	950	S22	S22	180	87	3/26	F01	Silentbloc
H	F020T570HA80	80	3	760	760	--	--	70	84	3/25	F08	

BESTELNR N° COMMANDE ORDER NR BESTELLNR	BR LRG WID BR	BLADEN LAMES LEAVES BLATT.	B	C	D1	D2	PH FL FA SP	PAK EP TH PAK	DETAIL	MOD	OPMERKINGEN REMARQUES REMARKS BEMERKUNGEN
--	------------------------	-------------------------------------	---	---	----	----	----------------------	------------------------	--------	-----	--

SERIE : -**2433****voor-avant-front-Vorne**

A020T511ZA75	80	11	860	860	S22	S22	118	149	11/13.5	A01	
A020T677ZA75	80	14	860	860	S22	S22	176	147	14/10.5	A01	Silentbloc
A020T651ZA75	80	11/2	860	860	S22	S22	164	150	11/10.5+2/17	A01B	Silentbloc
F020T499ZA75	80	3	860	860	S22	S22	125	81	3/24	F01	
F020T501ZA75	80	4	860	860	S22	S22	115	100	4/22	F01	
F020T515ZA75	80	4	860	860	S22	S22	128	100	4/22	F01	
F020T497ZA75	80	4	860	860	S22	S22	148	93	1/21+3/20	F01	
F020T513ZA75	90	2/P	750	650	S22	S22	-14	62	2/13+P/20	F01.70	Silentbloc
F020T603ZA75	90	2/P	800	850	30	30	-40	51	2/17+P/14	F01.70	

achter-arrière-rear-Hinten

A020T354ZA70	94	14	750	750	--	--	100	252	14/18	A08R	
F020T676ZA75	80	6	790	620	S22	S22	73	156	6/23	F01	Silentbloc
F020T590ZA70	93	6	750	750	--	--	78	214	4/33+2/35	F08R	

BESTELNR N° COMMANDE ORDER NR BESTELNR	BR LRG WID BR	BLADEN LAMES LEAVES BLATT.	B	C	D1	D2	PH FL FA SP	PAK EP TH PAK	DETAIL	MOD	OPMERKINGEN REMARQUES REMARKS BEMERKUNGEN
---	------------------------	-------------------------------------	---	---	----	----	----------------------	------------------------	--------	-----	--

SERIE : -**2435****voor-avant-front-Vorne**

A020T235ZB75	90	12	900	900	25	25	200	122	2/11+10/10	A01	
A020T239ZB75	90	13	900	900	25	25	130	156	13/12	A01	
A020T485ZA75	90	14	900	900	25	25	65	198	2/15+12/14	A01	
A020T235ZA75	90	12	900	900	25	25	200	122	2/11+10/10	A01.16	Vervangen
F020T605ZA75	90	5	765	900	30	25	215	115	5/20	F01	
F020T601ZA75	90	5	900	765	25	25	123	115	5/20	F01	
F020T611ZA75	90	3	900	900	25	25	108	78	3/23.5	F01	
F020T303ZA75	90	3	900	900	25	25	163	72	3/21	F01	
F020T503ZA75	90	4	900	900	25	25	132	100	4/22	F01	
F020T299ZA75	90	4	900	900	25	25	166	90	1/21+3/19	F01	
F020T369ZA75	90	4	900	900	25	25	150	96	4/21	F01	
F020T617ZA75	90	2	750	570	30	30	24	35	2/13	F01.70	
F020T567ZA75	90	2	750	570	30	30	-15	36	2/14	F01.70	
F020T453ZA75	90	2	750	570	30	30	28	35	2/13	F01.70	
F020T425ZA75	90	2	750	570	30	30	-12	37	2/14	F01.70	
F020T603ZA75	90	2/P	800	850	30	30	-40	51	2/17+P/14	F01.70	
F020T561ZA75	90	2/P	800	850	30	30	-70	50	1/16+1/18+P/13	F01.70	

achter-arrière-rear-Hinten

A020T452ZA75	100	7/4	780	620	30	30	120	148	7/12+4/16	A01B	
A020T720ZA75	100	11/6	780	620	30	30	35	228	11/12+6/16	A01B	
A020T788ZA70	94	11	750	750	--	--	80	193	6/18+5/17	A08R	
A020T790ZA70	94	11	750	750	--	--		193	6/18+5/17	A08R	
F020T508ZA75	100	6	620	780	30	30	85	144	6/22	F01	
F020T626ZA76	100	3/P/2	950	950	30	30	168	143		F01A	
A H F020T626ZA75	100	3	950	950	30	30	168	87	3/26	F01	
H F020T626HA80	100	2	765	765	--	--	108	48	2/21	F08	
F020T304ZA70	93	5	925	925	--	--	127	151	1/27+4/26	F08R	
F020T696ZA70	93	5	925	925	--	--	155	151	1/27+4/26	F08R	
F020T668ZA70	94	5	770	770	--	--	82	190	5/36	F08R	

BESTELNR N° COMMANDE ORDER NR BESTELNR	BR LRG WID BR	BLADEN LAMES LEAVES BLATT.	B	C	D1	D2	PH FL FA SP	PAK EP TH PAK	DETAIL	MOD	OPMERKINGEN REMARQUES REMARKS BEMERKUNGEN
---	------------------------	-------------------------------------	---	---	----	----	----------------------	------------------------	--------	-----	--

SERIE : -

2444

voor-avant-front-Vorne

A020T235ZB75	90	12	900	900	25	25	200	122	2/11+10/10	A01	
A020T323ZA75	90	12	900	900	25	25	90	175	7/15+5/14	A01	
A020T239ZB75	90	13	900	900	25	25	130	156	13/12	A01	
A020T485ZA75	90	14	900	900	25	25	65	198	2/15+12/14	A01	
A020T235ZA75	90	12	900	900	25	25	200	122	2/11+10/10	A01.16	Vervangen
F020T369ZA75	90	4	900	900	25	25	150	96	4/21	F01	
F020T299ZA75	90	4	900	900	25	25	166	90	1/21+3/19	F01	
F020T617ZA75	90	2	750	570	30	30	24	35	2/13	F01.70	

achter-arrière-rear-Hinten

A	A020T270ZC76	100	8/P/6	900	900	30	30	195	212		A01A	
H	A020T270ZC75	100	8	900	900	30	30	195	115	3/15+5/14	A01	
H	A020T270HC80	100	6	750	750	--	--	90	84	6/14	A08	
A	A020T310ZC76	100	9/P/7	900	900	30	30	170	242		A01A	
H	A020T310ZC75	100	9	900	900	30	30	170	130	4/15+5/14	A01	
H	A020T310HC80	100	7	770	770	--	--	70	98	7/14	A08	
A	A020T242ZC76	100	11/P/10	900	900	30	30	190	303		A01A	
H	A020T242ZC75	100	11	900	900	30	30	190	160	6/15+5/14	A01	
H	A020T242HC80	100	10	750	750	--	--	67	130	10/13	A08	
A	A020T310ZB76	100	9/P/7	900	900	30	30	170	242		A01A.17	
H	A020T310ZB75	100	9	900	900	30	30	170	130	4/15+5/14	A01.17	
H	A020T310HB80	100	7	770	770	--	--	70	98	7/14	A08	
A	A020T242ZB76	100	11/P/10	900	900	30	30	190	303		A01A.17	Vervangen
H	A020T242ZB75	100	11	900	900	30	30	190	160	5/15+1/14+1/15+4	A01.17	Vervangen
H	A020T242HB80	100	10	750	750	--	--	67	130	10/13	A08	
A	F020T296ZA76	100	3/P/P/2	900	900	30	30	200	218		F01A	
H	F020T296ZA75	100	3	900	900	30	30	200	84	3/25	F01	
H	F020T296HA80	100	2	740	740	--	--	110	54	2/24	F08	
A	F020T456ZA76	100	3/P/3	900	900	30	30	146	179		F01A	
H	F020T456ZA75	100	3	900	900	30	30	146	84	3/25	F01	
H	F020T456HA80	100	3	740	740	--	--	90	81	3/24	F08	

BESTELNR N° COMMANDE ORDER NR BESTELNR	BR LRG WID BR	BLADEN LAMES LEAVES BLATT.	B	C	D1	D2	PH FL FA SP	PAK EP TH PAK	DETAIL	MOD	OPMERKINGEN REMARQUES REMARKS BEMERKUNGEN
---	------------------------	-------------------------------------	---	---	----	----	----------------------	------------------------	--------	-----	--

SERIE : -

2448

voor-avant-front-Vorne

A020T235ZB75	90	12	900	900	25	25	200	122	2/11+10/10	A01	
A020T653ZA75	90	12	900	900	S24	S24	190	123	2/11+9/10+1/11	A01	Silentbloc
A020T615ZA75	90	13	900	900	S24	S24	120	158	2/13+11/12	A01	Silentbloc
A020T239ZB75	90	13	900	900	25	25	130	156	13/12	A01	
A020T235ZA75	90	12	900	900	25	25	200	122	2/11+10/10	A01.16	Vervangen
F020T517ZA75	80	4	860	860	S22	S22	204	100	4/22	F01	
F020T515ZA75	80	4	860	860	S22	S22	128	100	4/22	F01	
F020T605ZA75	90	5	765	900	30	25	215	115	5/20	F01	
F020T601ZA75	90	5	900	765	25	25	123	115	5/20	F01	
F020T303ZA75	90	3	900	900	25	25	163	72	3/21	F01	
F020T299ZA75	90	4	900	900	25	25	166	90	1/21+3/19	F01	
F020T585ZA75	90	4	900	900	S24	S24	179	92	4/20	F01	
F020T595ZA75	90	4	900	900	S24	S24	152	104	4/23	F01	
F020T369ZA75	90	4	900	900	25	25	150	96	4/21	F01	
F020T591ZA75	90	4	900	900	S24	S24	150	96	4/21	F01	
F020T567ZA75	90	2	750	570	30	30	-15	36	2/14	F01.70	

achter-arrière-rear-Hinten

A020T716ZA75	100	11/6	780	620	S24	30	35	228	11/12+6/16	A01B	Silentbloc
A020T720ZA75	100	11/6	780	620	30	30	35	228	11/12+6/16	A01B	
A020T788ZA70	94	11	750	750	--	--	80	193	6/18+5/17	A08R	
A020T790ZA70	94	11	750	750	--	--		193	6/18+5/17	A08R	
F020T508ZA75	100	6	620	780	30	30	85	144	6/22	F01	
F020T834ZA75	100	6	780	620	S24	30		144	6/22	F01	
F020T882ZA75	100	6	780	620	S24	S24	110/81	144	1/24+5/22	F01	Silentbloc
F020T696ZA70	93	5	925	925	--	--	155	151	1/27+4/26	F08R	
F020T304ZA70	93	5	925	925	--	--	127	151	1/27+4/26	F08R	
F020T692ZA70	104	4	765	765	--	--	40	152	4/36	F08R	

BESTELNR N° COMMANDE ORDER NR BESTELNR	BR LRG WID BR	BLADEN LAMES LEAVES BLATT.	B	C	D1	D2	PH FL FA SP	PAK EP TH PAK	DETAIL	MOD	OPMERKINGEN REMARKS REMARKS BEMERKUNGEN
---	------------------------	-------------------------------------	---	---	----	----	----------------------	------------------------	--------	-----	--

SERIE : -**2524****voor-avant-front-Vorne**

A020T511ZA75	80	11	860	860	S22	S22	118	149	11/13.5	A01	
A020T677ZA75	80	14	860	860	S22	S22	176	147	14/10.5	A01	Silentbloc
F020T515ZA75	80	4	860	860	S22	S22	128	100	4/22	F01	
F020T597ZA75	90	2	800	840	S24	S24	-55	51	2/17+P/14	F01.70	Silentbloc

achter-arrière-rear-Hinten

A020T354ZA70	94	14	750	750	--	--	100	252	14/18	A08R	
F020T676ZA75	80	6	790	620	S22	S22	73	156	6/23	F01	Silentbloc
F020T590ZA70	93	6	750	750	--	--	78	214	4/33+2/35	F08R	
F020T804ZA70	94	3	750	750	--	--	75	135	3/43	F08R	

2527**voor-avant-front-Vorne**

A020T511ZA75	80	11	860	860	S22	S22	118	149	11/13.5	A01	
A020T677ZA75	80	14	860	860	S22	S22	176	147	14/10.5	A01	Silentbloc
F020T515ZA75	80	4	860	860	S22	S22	128	100	4/22	F01	
F020T597ZA75	90	2	800	840	S24	S24	-55	51	2/17+P/14	F01.70	Silentbloc

achter-arrière-rear-Hinten

A020T390ZA70	90	11	745	745	--	--	65	220	11/20	A08R	
A020T354ZA70	94	14	750	750	--	--	100	252	14/18	A08R	
F020T676ZA75	80	6	790	620	S22	S22	73	156	6/23	F01	Silentbloc
F020T590ZA70	93	6	750	750	--	--	78	214	4/33+2/35	F08R	
F020T804ZA70	94	3	750	750	--	--	75	135	3/43	F08R	

BESTELNR N° COMMANDE ORDER NR BESTELNR	BR LRG WID BR	BLADEN LAMES LEAVES BLATT.	B	C	D1	D2	PH FL FA SP	PAK EP TH PAK	DETAIL	MOD	OPMERKINGEN REMARQUES REMARKS BEMERKUNGEN
---	------------------------	-------------------------------------	---	---	----	----	----------------------	------------------------	--------	-----	--

SERIE : -

2528

voor-avant-front-Vorne

A020T333ZA75	90	10	900	900	25	25	80	145	5/15+5/14	A01	
A020T323ZA75	90	12	900	900	25	25	90	175	7/15+5/14	A01	
A020T239ZB75	90	13	900	900	25	25	130	156	13/12	A01	
A020T485ZA75	90	14	900	900	25	25	65	198	2/15+12/14	A01	
A020T243ZB75	90	10	900	900	25	25	80	145	5/15+5/14	A01.16	Vervangen
F020T369ZA75	90	4	900	900	25	25	150	96	4/21	F01	
F020T503ZA75	90	4	900	900	25	25	132	100	4/22	F01	

achter-arrière-rear-Hinten

	A020T310ZC76	100	9/P/7	900	900	30	30	170	242		A01A	
A	A020T310ZC75	100	9	900	900	30	30	170	130	4/15+5/14	A01	
H	A020T310HC80	100	7	770	770	--	--	70	98	7/14	A08	
	A020T242ZC76	100	11/P/10	900	900	30	30	190	303		A01A	
A	A020T242ZC75	100	11	900	900	30	30	190	160	6/15+5/14	A01	
H	A020T242HC80	100	10	750	750	--	--	67	130	10/13	A08	
	A020T310ZB76	100	9/P/7	900	900	30	30	170	242		A01A.17	
A	A020T310ZB75	100	9	900	900	30	30	170	130	4/15+5/14	A01.17	
H	A020T310HB80	100	7	770	770	--	--	70	98	7/14	A08	
	A020T242ZB76	100	11/P/10	900	900	30	30	190	303		A01A.17	Vervangen
A	A020T242ZB75	100	11	900	900	30	30	190	160	5/15+1/14+1/15+4	A01.17	Vervangen
H	A020T242HB80	100	10	750	750	--	--	67	130	10/13	A08	
	F020T456ZA76	100	3/P/3	900	900	30	30	146	179		F01A	
A	F020T456ZA75	100	3	900	900	30	30	146	84	3/25	F01	
H	F020T456HA80	100	3	740	740	--	--	90	81	3/24	F08	

BESTELNR N° COMMANDE ORDER NR BESTELNR	BR LRG WID BR	BLADEN LAMES LEAVES BLATT.	B	C	D1	D2	PH FL FA SP	PAK EP TH PAK	DETAIL	MOD	OPMERKINGEN REMARQUES REMARKS BEMERKUNGEN
---	------------------------	-------------------------------------	---	---	----	----	----------------------	------------------------	--------	-----	--

SERIE : -**2531****voor-avant-front-Vorne**

A020T511ZA75	80	11	860	860	S22	S22	118	149	11/13.5	A01	
A020T677ZA75	80	14	860	860	S22	S22	176	147	14/10.5	A01	Silentbloc
A020T311ZB75	90	9	900	900	25	25	135	117	9/13	A01	
A020T607ZA75	90	10	900	900	S24	S24	75	145	5/15+5/14	A01	Silentbloc
A020T333ZA75	90	10	900	900	25	25	80	145	5/15+5/14	A01	
A020T615ZA75	90	13	900	900	S24	S24	120	158	2/13+11/12	A01	Silentbloc
A020T485ZA75	90	14	900	900	25	25	65	198	2/15+12/14	A01	
A020T623ZA75	90	14	900	900	S24	S24	70	198	2/15+12/14	A01	Silentbloc
A020T243ZB75	90	10	900	900	25	25	80	145	5/15+5/14	A01.16	Vervangen
F020T499ZA75	80	3	860	860	S22	S22	125	81	3/24	F01	
F020T515ZA75	80	4	860	860	S22	S22	128	100	4/22	F01	
F020T583ZA75	80	4	860	860	S22	S22	143	98	1/20+3/22	F01	
F020T497ZA75	80	4	860	860	S22	S22	148	93	1/21+3/20	F01	
F020T303ZA75	90	3	900	900	25	25	163	72	3/21	F01	
F020T591ZA75	90	4	900	900	S24	S24	150	96	4/21	F01	
F020T655ZA75	90	4	900	900	S24	S24	128	100	4/22	F01	
F020T595ZA75	90	4	900	900	S24	S24	152	104	4/23	F01	
F020T585ZA75	90	4	900	900	S24	S24	179	92	4/20	F01	
F020T503ZA75	90	4	900	900	25	25	132	100	4/22	F01	
F020T369ZA75	90	4	900	900	25	25	150	96	4/21	F01	
F020T513ZA75	90	2/P	750	650	S22	S22	-14	62	2/13+P/20	F01.70	Silentbloc
F020T597ZA75	90	2	800	840	S24	S24	-55	51	2/17+P/14	F01.70	Silentbloc

BESTELNR N° COMMANDE ORDER NR BESTELNR	BR LRG WID BR	BLADEN LAMES LEAVES BLATT.	B	C	D1	D2	PH FL FA SP	PAK EP TH PAK	DETAIL	MOD	OPMERKINGEN REMARQUES REMARKS BEMERKUNGEN
---	------------------------	-------------------------------------	---	---	----	----	----------------------	------------------------	--------	-----	--

SERIE : -**2531****achter-arrière-rear-Hinten**

A	A020T652ZA76	80	7/P/7	950	950	S22	S22	177	244		A01A	Silentbloc
H	A020T652ZA75	80	7	950	950	S22	S22	177	112	7/16	A01	Silentbloc
H	A020T652HA80	80	7	775	775	--	--	43	112	7/16	A08	
A	A020T654ZA76	80	9/7	950	950	S22	S22	126	272		A01A	Silentbloc
H	A020T654ZA75	80	9	950	950	S22	S22	125	153	9/17	A01	Silentbloc
H	A020T654HA80	80	7	750	750	--	--	0	119	7/17	A08	
A	A020T740ZA76	100	8/P/6	900	900	S24	S24	195	212		A01A	Silentbloc
H	A020T740ZA75	100	8	900	900	S24	S24		115	3/15+5/14	A01	Silentbloc
H	A020T740HA80	100	6	750	750			90	84	6/14	A08	
A	A020T270ZC76	100	8/P/6	900	900	30	30	195	212		A01A	
H	A020T270ZC75	100	8	900	900	30	30	195	115	3/15+5/14	A01	
H	A020T270HC80	100	6	750	750	--	--	90	84	6/14	A08	
A	A020T684ZA76	100	9/P/7	900	900	S24	S24	170	242		A01A	Silentbloc
H	A020T684ZA75	100	9	900	900	S24	S24	170	130	4/15+5/14	A01	Silentbloc
H	A020T684HA80	100	7	745	745	--	--	80	98	7/14	A08	
A	A020T310ZC76	100	9/P/7	900	900	30	30	170	242		A01A	
H	A020T310ZC75	100	9	900	900	30	30	170	130	4/15+5/14	A01	
H	A020T310HC80	100	7	770	770	--	--	70	98	7/14	A08	
A	A020T310ZB76	100	9/P/7	900	900	30	30	170	242		A01A.17	
H	A020T310ZB75	100	9	900	900	30	30	170	130	4/15+5/14	A01.17	
H	A020T310HB80	100	7	770	770	--	--	70	98	7/14	A08	
	A020T452ZA75	100	7/4	780	620	30	30	120	148	7/12+4/16	A01B	
	A020T354ZA70	94	14	750	750	--	--	100	252	14/18	A08R	
	F020T676ZA75	80	6	790	620	S22	S22	73	156	6/23	F01	Silentbloc
	F020T834ZA75	100	6	780	620	S24	30		144	6/22	F01	
A	F020T586ZA76	80	4/4	950	725	S22	S22	140	214		F01A	Silentbloc
H	F020T586ZA75	80	4	950	725	S22	S22	140	118	4/24	F01	Silentbloc
H	F020T586HA80	80	4	770	550	--	--	45	96	4/21	F08	
A	F020T800ZA76	80	3/3	950	950	S22	S22	180	171		F01A	Silentbloc
H	F020T800ZA75	80	3	950	950	S22	S22	180	87	3/26	F01	Silentbloc
H	F020T800HA80	80	3	760	760	--	--	70	84	3/25	F08	
A	F020T570ZA76	80	3/3	950	950	S22	S22	180	171		F01A	Silentbloc
H	F020T570ZA75	80	3	950	950	S22	S22	180	87	3/26	F01	Silentbloc
H	F020T570HA80	80	3	760	760	--	--	70	84	3/25	F08	
A	F020T746ZA76	100	3/P/P/2	900	900	S24	S24	195	213		F01A	Silentbloc
H	F020T746ZA75	100	3	900	900	S24	S24	195	81	2/25	F01	Silentbloc
H	F020T746HA80	100	2	740	740	--	--	129	52	2/24	F08	
A	F020T296ZA76	100	3/P/P/2	900	900	30	30	200	218		F01A	
H	F020T296ZA75	100	3	900	900	30	30	200	84	3/25	F01	
H	F020T296HA80	100	2	740	740	--	--	110	54	2/24	F08	

BESTELNR N° COMMANDE ORDER NR BESTELNR	BR LRG WID BR	BLADEN LAMES LEAVES BLATT.	B	C	D1	D2	PH FL FA SP	PAK EP TH PAK	DETAIL	MOD	OPMERKINGEN REMARQUES REMARKS BEMERKUNGEN
---	------------------------	-------------------------------------	---	---	----	----	----------------------	------------------------	--------	-----	--

SERIE : -**2531**

	F020T628ZA76	100	3/P/2	900	900	30	30	169	124		F01A	
A	F020T628ZA75	100	3	900	900	30	30	169	81	3/24	F01	
H	F020T628HA80	100	2	740	740	--	--	115	48	2/21	F08	
	F020T750ZA76	100	3/P/2	900	900	S24	S24	169	138	3/24+2/21	F01A	Silentbloc
A	F020T750ZA75	100	3	900	900	S24	S24	169	78	3/24	F01	Silentbloc
H	F020T750HA80	100	2	740	740	--	--	130	46	2/21	F08	
	F020T456ZA76	100	3/P/3	900	900	30	30	146	179		F01A	
A	F020T456ZA75	100	3	900	900	30	30	146	84	3/25	F01	
H	F020T456HA80	100	3	740	740	--	--	90	81	3/24	F08	
	F020T724ZA76	100	3/P/3	900	900	S24	S24	145	173		F01A	Silentbloc
A	F020T724ZA75	100	3	900	900	S24	S24	145	81	3/25	F01	Silentbloc
H	F020T724HA80	100	3	740	740	--	--	96	78	3/24	F08	
	F020T690ZA76	100	4/P/P/3	900	900	30	30	143	219		F01A	
A	F020T690ZA75	100	4	900	900	30	30	143	104	4/24	F01	
H	F020T690HA80	100	3	740	740	--	--	90	72	3/22	F08	
	F020T682ZA76	100	4/P/P/3	900	900	S24	S24	147	220		F01A	Silentbloc
A	F020T682ZA75	100	4	900	900	S24	S24	147	104	4/24	F01	Silentbloc
H	F020T682HA80	100	3	740	740	--	--	85	72	3/22	F08	
	F020T590ZA70	93	6	750	750	--	--	78	214	4/33+2/35	F08R	
	F020T804ZA70	94	3	750	750	--	--	75	135	3/43	F08R	

BESTELNR N° COMMANDE ORDER NR BESTELNR	BR LRG WID BR	BLADEN LAMES LEAVES BLATT.	B	C	D1	D2	PH FL FA SP	PAK EP TH PAK	DETAIL	MOD	OPMERKINGEN REMARQUES REMARKS BEMERKUNGEN
---	------------------------	-------------------------------------	---	---	----	----	----------------------	------------------------	--------	-----	--

SERIE : -

2534

voor-avant-front-Vorne

A020T511ZA75	80	11	860	860	S22	S22	118	149	11/13.5	A01	
A020T677ZA75	80	14	860	860	S22	S22	176	147	14/10.5	A01	Silentbloc
A020T651ZA75	80	11/2	860	860	S22	S22	164	150	11/10.5+2/17	A01B	Silentbloc
F020T499ZA75	80	3	860	860	S22	S22	125	81	3/24	F01	
F020T515ZA75	80	4	860	860	S22	S22	128	100	4/22	F01	
F020T303ZA75	90	3	900	900	25	25	163	72	3/21	F01	
F020T591ZA75	90	4	900	900	S24	S24	150	96	4/21	F01	
F020T595ZA75	90	4	900	900	S24	S24	152	104	4/23	F01	
F020T585ZA75	90	4	900	900	S24	S24	179	92	4/20	F01	
F020T369ZA75	90	4	900	900	25	25	150	96	4/21	F01	

achter-arrière-rear-Hinten

A020T354ZA70	94	14	750	750	--	--	100	252	14/18	A08R	
F020T676ZA75	80	6	790	620	S22	S22	73	156	6/23	F01	Silentbloc
F020T750ZA76	100	3/P/2	900	900	S24	S24	169	138	3/24+2/21	F01A	Silentbloc
A F020T750ZA75	100	3	900	900	S24	S24	169	78	3/24	F01	Silentbloc
H F020T750HA80	100	2	740	740	--	--	130	46	2/21	F08	
F020T746ZA76	100	3/P/P/2	900	900	S24	S24	195	213		F01A	Silentbloc
A F020T746ZA75	100	3	900	900	S24	S24	195	81	2/25	F01	Silentbloc
H F020T746HA80	100	2	740	740	--	--	129	52	2/24	F08	
F020T296ZA76	100	3/P/P/2	900	900	30	30	200	218		F01A	
A F020T296ZA75	100	3	900	900	30	30	200	84	3/25	F01	
H F020T296HA80	100	2	740	740	--	--	110	54	2/24	F08	
F020T628ZA76	100	3/P/2	900	900	30	30	169	124		F01A	
A F020T628ZA75	100	3	900	900	30	30	169	81	3/24	F01	
H F020T628HA80	100	2	740	740	--	--	115	48	2/21	F08	
F020T456ZA76	100	3/P/3	900	900	30	30	146	179		F01A	
A F020T456ZA75	100	3	900	900	30	30	146	84	3/25	F01	
H F020T456HA80	100	3	740	740	--	--	90	81	3/24	F08	
F020T724ZA76	100	3/P/3	900	900	S24	S24	145	173		F01A	Silentbloc
A F020T724ZA75	100	3	900	900	S24	S24	145	81	3/25	F01	Silentbloc
H F020T724HA80	100	3	740	740	--	--	96	78	3/24	F08	
F020T590ZA70	93	6	750	750	--	--	78	214	4/33+2/35	F08R	
F020T804ZA70	94	3	750	750	--	--	75	135	3/43	F08R	

BESTELNR N° COMMANDE ORDER NR BESTELNR	BR LRG WID BR	BLADEN LAMES LEAVES BLATT.	B	C	D1	D2	PH FL FA SP	PAK EP TH PAK	DETAIL	MOD	OPMERKINGEN REMARQUES REMARKS BEMERKUNGEN
---	------------------------	-------------------------------------	---	---	----	----	----------------------	------------------------	--------	-----	--

SERIE : -

2538

voor-avant-front-Vorne

A020T653ZA75	90	12	900	900	S24	S24	190	123	2/11+9/10+1/11	A01	Silentbloc
A020T235ZB75	90	12	900	900	25	25	200	122	2/11+10/10	A01	
A020T615ZA75	90	13	900	900	S24	S24	120	158	2/13+11/12	A01	Silentbloc
A020T239ZB75	90	13	900	900	25	25	130	156	13/12	A01	
A020T235ZA75	90	12	900	900	25	25	200	122	2/11+10/10	A01.16	Vervangen
F020T605ZA75	90	5	765	900	30	25	215	115	5/20	F01	
F020T601ZA75	90	5	900	765	25	25	123	115	5/20	F01	
F020T611ZA75	90	3	900	900	25	25	108	78	3/23.5	F01	
F020T303ZA75	90	3	900	900	25	25	163	72	3/21	F01	
F020T655ZA75	90	4	900	900	S24	S24	128	100	4/22	F01	
F020T595ZA75	90	4	900	900	S24	S24	152	104	4/23	F01	
F020T591ZA75	90	4	900	900	S24	S24	150	96	4/21	F01	
F020T585ZA75	90	4	900	900	S24	S24	179	92	4/20	F01	
F020T503ZA75	90	4	900	900	25	25	132	100	4/22	F01	
F020T369ZA75	90	4	900	900	25	25	150	96	4/21	F01	
F020T299ZA75	90	4	900	900	25	25	166	90	1/21+3/19	F01	
F020T597ZA75	90	2	800	840	S24	S24	-55	51	2/17+P/14	F01.70	Silentbloc

achter-arrière-rear-Hinten

A020T720ZA75	100	11/6	780	620	30	30	35	228	11/12+6/16	A01B	
A020T716ZA75	100	11/6	780	620	S24	30	35	228	11/12+6/16	A01B	Silentbloc
A020T788ZA70	94	11	750	750	--	--	80	193	6/18+5/17	A08R	
A020T790ZA70	94	11	750	750	--	--		193	6/18+5/17	A08R	
F020T508ZA75	100	6	620	780	30	30	85	144	6/22	F01	
F020T834ZA75	100	6	780	620	S24	30		144	6/22	F01	
F020T882ZA75	100	6	780	620	S24	S24	110/81	144	1/24+5/22	F01	Silentbloc
F020T696ZA70	93	5	925	925	--	--	155	151	1/27+4/26	F08R	
F020T668ZA70	94	5	770	770	--	--	82	190	5/36	F08R	

BESTELNR N° COMMANDE ORDER NR BESTELNR	BR LRG WID BR	BLADEN LAMES LEAVES BLATT.	B	C	D1	D2	PH FL FA SP	PAK EP TH PAK	DETAIL	MOD	OPMERKINGEN REMARQUES REMARKS BEMERKUNGEN
---	------------------------	-------------------------------------	---	---	----	----	----------------------	------------------------	--------	-----	--

SERIE : -

2544

voor-avant-front-Vorne

A020T235ZB75	90	12	900	900	25	25	200	122	2/11+10/10	A01	
A020T239ZB75	90	13	900	900	25	25	130	156	13/12	A01	
A020T235ZA75	90	12	900	900	25	25	200	122	2/11+10/10	A01.16	Vervangen
F020T611ZA75	90	3	900	900	25	25	108	78	3/23.5	F01	
F020T303ZA75	90	3	900	900	25	25	163	72	3/21	F01	
F020T585ZA75	90	4	900	900	S24	S24	179	92	4/20	F01	
F020T591ZA75	90	4	900	900	S24	S24	150	96	4/21	F01	
F020T655ZA75	90	4	900	900	S24	S24	128	100	4/22	F01	
F020T299ZA75	90	4	900	900	25	25	166	90	1/21+3/19	F01	
F020T503ZA75	90	4	900	900	25	25	132	100	4/22	F01	
F020T369ZA75	90	4	900	900	25	25	150	96	4/21	F01	

achter-arrière-rear-Hinten

A020T720ZA75	100	11/6	780	620	30	30	35	228	11/12+6/16	A01B	
A020T788ZA70	94	11	750	750	--	--	80	193	6/18+5/17	A08R	
A020T790ZA70	94	11	750	750	--	--		193	6/18+5/17	A08R	
F020T508ZA75	100	6	620	780	30	30	85	144	6/22	F01	
F020T834ZA75	100	6	780	620	S24	30		144	6/22	F01	
F020T882ZA75	100	6	780	620	S24	S24	110/81	144	1/24+5/22	F01	Silentbloc
F020T304ZA70	93	5	925	925	--	--	127	151	1/27+4/26	F08R	
F020T696ZA70	93	5	925	925	--	--	155	151	1/27+4/26	F08R	
F020T668ZA70	94	5	770	770	--	--	82	190	5/36	F08R	

BESTELNR N° COMMANDE ORDER NR BESTELNR	BR LRG WID BR	BLADEN LAMES LEAVES BLATT.	B	C	D1	D2	PH FL FA SP	PAK EP TH PAK	DETAIL	MOD	OPMERKINGEN REMARQUES REMARKS BEMERKUNGEN
---	------------------------	-------------------------------------	---	---	----	----	----------------------	------------------------	--------	-----	--

SERIE : -**2550****voor-avant-front-Vorne**

A020T653ZA75	90	12	900	900	S24	S24	190	123	2/11+9/10+1/11	A01	Silentbloc
A020T235ZB75	90	12	900	900	25	25	200	122	2/11+10/10	A01	
A020T615ZA75	90	13	900	900	S24	S24	120	158	2/13+11/12	A01	Silentbloc
A020T239ZB75	90	13	900	900	25	25	130	156	13/12	A01	
A020T235ZA75	90	12	900	900	25	25	200	122	2/11+10/10	A01.16	Vervangen
F020T517ZA75	80	4	860	860	S22	S22	204	100	4/22	F01	
F020T515ZA75	80	4	860	860	S22	S22	128	100	4/22	F01	
F020T605ZA75	90	5	765	900	30	25	215	115	5/20	F01	
F020T601ZA75	90	5	900	765	25	25	123	115	5/20	F01	
F020T303ZA75	90	3	900	900	25	25	163	72	3/21	F01	
F020T369ZA75	90	4	900	900	25	25	150	96	4/21	F01	
F020T591ZA75	90	4	900	900	S24	S24	150	96	4/21	F01	
F020T585ZA75	90	4	900	900	S24	S24	179	92	4/20	F01	
F020T503ZA75	90	4	900	900	25	25	132	100	4/22	F01	
F020T595ZA75	90	4	900	900	S24	S24	152	104	4/23	F01	
F020T299ZA75	90	4	900	900	25	25	166	90	1/21+3/19	F01	
F020T617ZA75	90	2	750	570	30	30	24	35	2/13	F01.70	
F020T567ZA75	90	2	750	570	30	30	-15	36	2/14	F01.70	

achter-arrière-rear-Hinten

A020T720ZA75	100	11/6	780	620	30	30	35	228	11/12+6/16	A01B	
A020T790ZA70	94	11	750	750	--	--		193	6/18+5/17	A08R	
A020T788ZA70	94	11	750	750	--	--	80	193	6/18+5/17	A08R	
F020T508ZA75	100	6	620	780	30	30	85	144	6/22	F01	
F020T882ZA75	100	6	780	620	S24	S24	110/81	144	1/24+5/22	F01	Silentbloc
F020T834ZA75	100	6	780	620	S24	30		144	6/22	F01	
F020T696ZA70	93	5	925	925	--	--	155	151	1/27+4/26	F08R	
F020T304ZA70	93	5	925	925	--	--	127	151	1/27+4/26	F08R	

BESTELNR N° COMMANDE ORDER NR BESTELNR	BR LRG WID BR	BLADEN LAMES LEAVES BLATT.	B	C	D1	D2	PH FL FA SP	PAK EP TH PAK	DETAIL	MOD	OPMERKINGEN REMARKS BEMERKUNGEN
---	------------------------	-------------------------------------	---	---	----	----	----------------------	------------------------	--------	-----	---------------------------------------

SERIE : -**2628****voor-avant-front-Vorne**

A020T421ZA75	90	12	765	900	30	25	210	144	12/12	A01	
A020T589ZA75	90	12	900	765	25	25	78	144	12/12	A01	
A020T419ZA75	90	12	900	765	25	25	120	144	12/12	A01	
A020T311ZB75	90	9	900	900	25	25	135	117	9/13	A01	
A020T333ZA75	90	10	900	900	25	25	80	145	5/15+5/14	A01	
A020T323ZA75	90	12	900	900	25	25	90	175	7/15+5/14	A01	
A020T235ZB75	90	12	900	900	25	25	200	122	2/11+10/10	A01	
A020T239ZB75	90	13	900	900	25	25	130	156	13/12	A01	
A020T485ZA75	90	14	900	900	25	25	65	198	2/15+12/14	A01	
A020T243ZB75	90	10	900	900	25	25	80	145	5/15+5/14	A01.16	Vervangen
A020T235ZA75	90	12	900	900	25	25	200	122	2/11+10/10	A01.16	Vervangen
F020T567ZA75	90	2	750	570	30	30	-15	36	2/14	F01.70	

achter-arrière-rear-Hinten

A020T104AA70	104	11	750	750	--	--	100	176	11/16	A08R	
A020T328ZA70	104	14	750	750	--	--	65	252	14/18	A08R	
A020T232ZA70	104	14	750	750	--	--	65	252	14/18	A08R	
A020T104ZA70	104	8	770	770	--	--	60	176	8/22	A08R	
A020T486ZA70	104	15	770	770	--	--	90	270	15/18	A08R	
A020T706ZA70	104	15	775	775	--	--	115	304	4/21+11/20	A08R	
A020T306ZA70	104	14	810	810	--	--	125	300	3/23+11/21	A08R	
A020T708ZA70	104	11	815	815	--	--	120	187	11/17	A08R	
A020T660ZA70	104	11	815	815	--	--	120	187	11/17	A08R	
A020T546ZA70	104	13	820	820	--	--	118	260	13/20	A08R	
A020T318ZA70	104	13	820	820	--	--	95	260	13/20	A08R	
A020T506ZA70	104	16	820	820	--	--	120	336	16/21	A08R	

BESTELNR N° COMMANDE ORDER NR BESTELNR	BR LRG WID BR	BLADEN LAMES LEAVES BLATT.	B	C	D1	D2	PH FL FA SP	PAK EP TH PAK	DETAIL	MOD	OPMERKINGEN REMARKS BEMERKUNGEN
---	------------------------	-------------------------------------	---	---	----	----	----------------------	------------------------	--------	-----	---------------------------------------

SERIE : -

2629

voor-avant-front-Vorne

A020T421ZA75	90	12	765	900	30	25	210	144	12/12	A01	
A020T509ZA75	90	17	765	900	30	25	220	187	17/11	A01	
A020T419ZA75	90	12	900	765	25	25	120	144	12/12	A01	
A020T589ZA75	90	12	900	765	25	25	78	144	12/12	A01	
A020T507ZA75	90	17	900	765	25	25	120	187	17/11	A01	
A020T311ZB75	90	9	900	900	25	25	135	117	9/13	A01	
A020T333ZA75	90	10	900	900	25	25	80	145	5/15+5/14	A01	
A020T235ZB75	90	12	900	900	25	25	200	122	2/11+10/10	A01	
A020T239ZB75	90	13	900	900	25	25	130	156	13/12	A01	
A020T485ZA75	90	14	900	900	25	25	65	198	2/15+12/14	A01	
A020T243ZB75	90	10	900	900	25	25	80	145	5/15+5/14	A01.16	Vervangen
A020T235ZA75	90	12	900	900	25	25	200	122	2/11+10/10	A01.16	Vervangen

achter-arrière-rear-Hinten

A020T104AA70	104	11	750	750	--	--	100	176	11/16	A08R	
A020T104ZA70	104	8	770	770	--	--	60	176	8/22	A08R	
A020T486ZA70	104	15	770	770	--	--	90	270	15/18	A08R	
A020T706ZA70	104	15	775	775	--	--	115	304	4/21+11/20	A08R	
A020T306ZA70	104	14	810	810	--	--	125	300	3/23+11/21	A08R	
A020T660ZA70	104	11	815	815	--	--	120	187	11/17	A08R	
A020T708ZA70	104	11	815	815	--	--	120	187	11/17	A08R	
A020T546ZA70	104	13	820	820	--	--	118	260	13/20	A08R	
A020T318ZA70	104	13	820	820	--	--	95	260	13/20	A08R	
A020T506ZA70	104	16	820	820	--	--	120	336	16/21	A08R	

BESTELNR N° COMMANDE ORDER NR BESTELNR	BR LRG WID BR	BLADEN LAMES LEAVES BLATT.	B	C	D1	D2	PH FL FA SP	PAK EP TH PAK	DETAIL	MOD	OPMERKINGEN REMARQUES REMARKS BEMERKUNGEN
---	------------------------	-------------------------------------	---	---	----	----	----------------------	------------------------	--------	-----	--

SERIE : -**2631****voor-avant-front-Vorne**

A020T333ZA75	90	10	900	900	25	25	80	145	5/15+5/14	A01	
A020T607ZA75	90	10	900	900	S24	S24	75	145	5/15+5/14	A01	Silentbloc
A020T239ZB75	90	13	900	900	25	25	130	156	13/12	A01	
A020T615ZA75	90	13	900	900	S24	S24	120	158	2/13+11/12	A01	Silentbloc
A020T485ZA75	90	14	900	900	25	25	65	198	2/15+12/14	A01	
A020T623ZA75	90	14	900	900	S24	S24	70	198	2/15+12/14	A01	Silentbloc
A020T243ZB75	90	10	900	900	25	25	80	145	5/15+5/14	A01.16	Vervangen
F020T655ZA75	90	4	900	900	S24	S24	128	100	4/22	F01	
F020T591ZA75	90	4	900	900	S24	S24	150	96	4/21	F01	
F020T595ZA75	90	4	900	900	S24	S24	152	104	4/23	F01	
F020T585ZA75	90	4	900	900	S24	S24	179	92	4/20	F01	

achter-arrière-rear-Hinten

A020T104AA70	104	11	750	750	--	--	100	176	11/16	A08R	
A020T104ZA70	104	8	770	770	--	--	60	176	8/22	A08R	
A020T486ZA70	104	15	770	770	--	--	90	270	15/18	A08R	
A020T706ZA70	104	15	775	775	--	--	115	304	4/21+11/20	A08R	
A020T306ZA70	104	14	810	810	--	--	125	300	3/23+11/21	A08R	
A020T708ZA70	104	11	815	815	--	--	120	187	11/17	A08R	
A020T318ZA70	104	13	820	820	--	--	95	260	13/20	A08R	
A020T546ZA70	104	13	820	820	--	--	118	260	13/20	A08R	
A020T506ZA70	104	16	820	820	--	--	120	336	16/21	A08R	

BESTELNR N° COMMANDE ORDER NR BESTELNR	BR LRG WID BR	BLADEN LAMES LEAVES BLATT.	B	C	D1	D2	PH FL FA SP	PAK EP TH PAK	DETAIL	MOD	OPMERKINGEN REMARQUES REMARKS BEMERKUNGEN
---	------------------------	-------------------------------------	---	---	----	----	----------------------	------------------------	--------	-----	--

SERIE : -**2633****voor-avant-front-Vorne**

A020T421ZA75	90	12	765	900	30	25	210	144	12/12	A01	
A020T419ZA75	90	12	900	765	25	25	120	144	12/12	A01	
A020T235ZB75	90	12	900	900	25	25	200	122	2/11+10/10	A01	
A020T323ZA75	90	12	900	900	25	25	90	175	7/15+5/14	A01	
A020T239ZB75	90	13	900	900	25	25	130	156	13/12	A01	
A020T485ZA75	90	14	900	900	25	25	65	198	2/15+12/14	A01	
A020T235ZA75	90	12	900	900	25	25	200	122	2/11+10/10	A01.16	Vervangen
F020T369ZA75	90	4	900	900	25	25	150	96	4/21	F01	

achter-arrière-rear-Hinten

A020T104AA70	104	11	750	750	--	--	100	176	11/16	A08R	
A020T328ZA70	104	14	750	750	--	--	65	252	14/18	A08R	
A020T104ZA70	104	8	770	770	--	--	60	176	8/22	A08R	
A020T486ZA70	104	15	770	770	--	--	90	270	15/18	A08R	
A020T306ZA70	104	14	810	810	--	--	125	300	3/23+11/21	A08R	
A020T660ZA70	104	11	815	815	--	--	120	187	11/17	A08R	
A020T708ZA70	104	11	815	815	--	--	120	187	11/17	A08R	
A020T546ZA70	104	13	820	820	--	--	118	260	13/20	A08R	
A020T318ZA70	104	13	820	820	--	--	95	260	13/20	A08R	
A020T506ZA70	104	16	820	820	--	--	120	336	16/21	A08R	

BESTELNR N° COMMANDE ORDER NR BESTELNR	BR LRG WID BR	BLADEN LAMES LEAVES BLATT.	B	C	D1	D2	PH FL FA SP	PAK EP TH PAK	DETAIL	MOD	OPMERKINGEN REMARKS BEMERKUNGEN
---	------------------------	-------------------------------------	---	---	----	----	----------------------	------------------------	--------	-----	---------------------------------------

SERIE : -**2635****voor-avant-front-Vorne**

A020T421ZA75	90	12	765	900	30	25	210	144	12/12	A01	
A020T589ZA75	90	12	900	765	25	25	78	144	12/12	A01	
A020T419ZA75	90	12	900	765	25	25	120	144	12/12	A01	
A020T311ZB75	90	9	900	900	25	25	135	117	9/13	A01	
A020T333ZA75	90	10	900	900	25	25	80	145	5/15+5/14	A01	
A020T323ZA75	90	12	900	900	25	25	90	175	7/15+5/14	A01	
A020T235ZB75	90	12	900	900	25	25	200	122	2/11+10/10	A01	
A020T239ZB75	90	13	900	900	25	25	130	156	13/12	A01	
A020T485ZA75	90	14	900	900	25	25	65	198	2/15+12/14	A01	
A020T243ZB75	90	10	900	900	25	25	80	145	5/15+5/14	A01.16	Vervangen
A020T235ZA75	90	12	900	900	25	25	200	122	2/11+10/10	A01.16	Vervangen
F020T549ZA75	80	3/P	860	860	25	25	128	98	3/23+P/23	F01	
F020T551ZA75	80	3/W	860	860	30	25	214	87	3/23+W	F01	
F020T503ZA75	90	4	900	900	25	25	132	100	4/22	F01	
F020T567ZA75	90	2	750	570	30	30	-15	36	2/14	F01.70	

achter-arrière-rear-Hinten

A020T104AA70	104	11	750	750	--	--	100	176	11/16	A08R	
A020T104ZA70	104	8	770	770	--	--	60	176	8/22	A08R	
A020T486ZA70	104	15	770	770	--	--	90	270	15/18	A08R	
A020T306ZA70	104	14	810	810	--	--	125	300	3/23+11/21	A08R	
A020T708ZA70	104	11	815	815	--	--	120	187	11/17	A08R	
A020T660ZA70	104	11	815	815	--	--	120	187	11/17	A08R	
A020T546ZA70	104	13	820	820	--	--	118	260	13/20	A08R	
A020T318ZA70	104	13	820	820	--	--	95	260	13/20	A08R	
A020T506ZA70	104	16	820	820	--	--	120	336	16/21	A08R	

BESTELNR N° COMMANDE ORDER NR BESTELNR	BR LRG WID BR	BLADEN LAMES LEAVES BLATT.	B	C	D1	D2	PH FL FA SP	PAK EP TH PAK	DETAIL	MOD	OPMERKINGEN REMARKS BEMERKUNGEN
---	------------------------	-------------------------------------	---	---	----	----	----------------------	------------------------	--------	-----	---------------------------------------

SERIE : -**2636****voor-avant-front-Vorne**

A020T421ZA75	90	12	765	900	30	25	210	144	12/12	A01	
A020T419ZA75	90	12	900	765	25	25	120	144	12/12	A01	
A020T589ZA75	90	12	900	765	25	25	78	144	12/12	A01	
A020T311ZB75	90	9	900	900	25	25	135	117	9/13	A01	
A020T333ZA75	90	10	900	900	25	25	80	145	5/15+5/14	A01	
A020T323ZA75	90	12	900	900	25	25	90	175	7/15+5/14	A01	
A020T235ZB75	90	12	900	900	25	25	200	122	2/11+10/10	A01	
A020T239ZB75	90	13	900	900	25	25	130	156	13/12	A01	
A020T485ZA75	90	14	900	900	25	25	65	198	2/15+12/14	A01	
A020T243ZB75	90	10	900	900	25	25	80	145	5/15+5/14	A01.16	Vervangen
A020T235ZA75	90	12	900	900	25	25	200	122	2/11+10/10	A01.16	Vervangen
F020T567ZA75	90	2	750	570	30	30	-15	36	2/14	F01.70	

achter-arrière-rear-Hinten

A020T104AA70	104	11	750	750	--	--	100	176	11/16	A08R	
A020T328ZA70	104	14	750	750	--	--	65	252	14/18	A08R	
A020T104ZA70	104	8	770	770	--	--	60	176	8/22	A08R	
A020T486ZA70	104	15	770	770	--	--	90	270	15/18	A08R	
A020T306ZA70	104	14	810	810	--	--	125	300	3/23+11/21	A08R	
A020T660ZA70	104	11	815	815	--	--	120	187	11/17	A08R	
A020T708ZA70	104	11	815	815	--	--	120	187	11/17	A08R	
A020T546ZA70	104	13	820	820	--	--	118	260	13/20	A08R	
A020T318ZA70	104	13	820	820	--	--	95	260	13/20	A08R	
A020T506ZA70	104	16	820	820	--	--	120	336	16/21	A08R	

BESTELNR N° COMMANDE ORDER NR BESTELNR	BR LRG WID BR	BLADEN LAMES LEAVES BLATT.	B	C	D1	D2	PH FL FA SP	PAK EP TH PAK	DETAIL	MOD	OPMERKINGEN REMARQUES REMARKS BEMERKUNGEN
---	------------------------	-------------------------------------	---	---	----	----	----------------------	------------------------	--------	-----	--

SERIE : -

2638

voor-avant-front-Vorne

A020T607ZA75	90	10	900	900	S24	S24	75	145	5/15+5/14	A01	Silentbloc
A020T333ZA75	90	10	900	900	25	25	80	145	5/15+5/14	A01	
A020T235ZB75	90	12	900	900	25	25	200	122	2/11+10/10	A01	
A020T615ZA75	90	13	900	900	S24	S24	120	158	2/13+11/12	A01	Silentbloc
A020T239ZB75	90	13	900	900	25	25	130	156	13/12	A01	
A020T623ZA75	90	14	900	900	S24	S24	70	198	2/15+12/14	A01	Silentbloc
A020T485ZA75	90	14	900	900	25	25	65	198	2/15+12/14	A01	
A020T243ZB75	90	10	900	900	25	25	80	145	5/15+5/14	A01.16	Vervangen
A020T235ZA75	90	12	900	900	25	25	200	122	2/11+10/10	A01.16	Vervangen
F020T655ZA75	90	4	900	900	S24	S24	128	100	4/22	F01	
F020T595ZA75	90	4	900	900	S24	S24	152	104	4/23	F01	

achter-arrière-rear-Hinten

A020T104AA70	104	11	750	750	--	--	100	176	11/16	A08R	
A020T328ZA70	104	14	750	750	--	--	65	252	14/18	A08R	
A020T104ZA70	104	8	770	770	--	--	60	176	8/22	A08R	
A020T486ZA70	104	15	770	770	--	--	90	270	15/18	A08R	
A020T706ZA70	104	15	775	775	--	--	115	304	4/21+11/20	A08R	
A020T306ZA70	104	14	810	810	--	--	125	300	3/23+11/21	A08R	
A020T708ZA70	104	11	815	815	--	--	120	187	11/17	A08R	
A020T546ZA70	104	13	820	820	--	--	118	260	13/20	A08R	
A020T506ZA70	104	16	820	820	--	--	120	336	16/21	A08R	
F020T692ZA70	104	4	765	765	--	--	40	152	4/36	F08R	

BESTELNR N° COMMANDE ORDER NR BESTELLNR	BR LRG WID BR	BLADEN LAMES LEAVES BLATT.	B	C	D1	D2	PH FL FA SP	PAK EP TH PAK	DETAIL	MOD	OPMERKINGEN REMARQUES REMARKS BEMERKUNGEN
--	------------------------	-------------------------------------	---	---	----	----	----------------------	------------------------	--------	-----	--

SERIE : -**2644****voor-avant-front-Vorne**

A020T421ZA75	90	12	765	900	30	25	210	144	12/12	A01	
A020T419ZA75	90	12	900	765	25	25	120	144	12/12	A01	
A020T235ZB75	90	12	900	900	25	25	200	122	2/11+10/10	A01	
A020T239ZB75	90	13	900	900	25	25	130	156	13/12	A01	
A020T235ZA75	90	12	900	900	25	25	200	122	2/11+10/10	A01.16	Vervangen
F020T567ZA75	90	2	750	570	30	30	-15	36	2/14	F01.70	

achter-arrière-rear-Hinten

A020T104AA70	104	11	750	750	--	--	100	176	11/16	A08R	
A020T328ZA70	104	14	750	750	--	--	65	252	14/18	A08R	
A020T104ZA70	104	8	770	770	--	--	60	176	8/22	A08R	
A020T486ZA70	104	15	770	770	--	--	90	270	15/18	A08R	
A020T306ZA70	104	14	810	810	--	--	125	300	3/23+11/21	A08R	
A020T546ZA70	104	13	820	820	--	--	118	260	13/20	A08R	
A020T318ZA70	104	13	820	820	--	--	95	260	13/20	A08R	
A020T506ZA70	104	16	820	820	--	--	120	336	16/21	A08R	

BESTELNR N° COMMANDE ORDER NR BESTELNR	BR LRG WID BR	BLADEN LAMES LEAVES BLATT.	B	C	D1	D2	PH FL FA SP	PAK EP TH PAK	DETAIL	MOD	OPMERKINGEN REMARQUES REMARKS BEMERKUNGEN
---	------------------------	-------------------------------------	---	---	----	----	----------------------	------------------------	--------	-----	--

SERIE : -**2648****voor-avant-front-Vorne**

A020T419ZA75	90	12	900	765	25	25	120	144	12/12	A01	
A020T311ZB75	90	9	900	900	25	25	135	117	9/13	A01	
A020T333ZA75	90	10	900	900	25	25	80	145	5/15+5/14	A01	
A020T235ZB75	90	12	900	900	25	25	200	122	2/11+10/10	A01	
A020T239ZB75	90	13	900	900	25	25	130	156	13/12	A01	
A020T485ZA75	90	14	900	900	25	25	65	198	2/15+12/14	A01	
A020T243ZB75	90	10	900	900	25	25	80	145	5/15+5/14	A01.16	Vervangen
A020T235ZA75	90	12	900	900	25	25	200	122	2/11+10/10	A01.16	Vervangen
F020T567ZA75	90	2	750	570	30	30	-15	36	2/14	F01.70	

achter-arrière-rear-Hinten

A020T104AA70	104	11	750	750	--	--	100	176	11/16	A08R	
A020T328ZA70	104	14	750	750	--	--	65	252	14/18	A08R	
A020T104ZA70	104	8	770	770	--	--	60	176	8/22	A08R	
A020T486ZA70	104	15	770	770	--	--	90	270	15/18	A08R	
A020T706ZA70	104	15	775	775	--	--	115	304	4/21+11/20	A08R	
A020T306ZA70	104	14	810	810	--	--	125	300	3/23+11/21	A08R	
A020T708ZA70	104	11	815	815	--	--	120	187	11/17	A08R	
A020T546ZA70	104	13	820	820	--	--	118	260	13/20	A08R	
A020T318ZA70	104	13	820	820	--	--	95	260	13/20	A08R	
A020T506ZA70	104	16	820	820	--	--	120	336	16/21	A08R	

BESTELNR N° COMMANDE ORDER NR BESTELNR	BR LRG WID BR	BLADEN LAMES LEAVES BLATT.	B	C	D1	D2	PH FL FA SP	PAK EP TH PAK	DETAIL	MOD	OPMERKINGEN REMARKS BEMERKUNGEN
---	------------------------	-------------------------------------	---	---	----	----	----------------------	------------------------	--------	-----	---------------------------------------

SERIE : -**3025****voor-avant-front-Vorne**

F020T555ZA75	80	4	860	860	30	25	220	96	4/22	F01.70
F020T553ZA75	80	4	860	860	25	25	147	96	4/22	F01.70
F020T477ZA75	80	4	860	860	25	25	151	96	4/22	F01.70
F020T479ZA75	80	4	860	860	30	25	205	96	4/22	F01.70

achter-arrière-rear-Hinten

F020T590ZA70	93	6	750	750	--	--	78	214	4/33+2/35	F08R
F020T536ZA70	93	5	765	765	--	--	113	165	5/31	F08R

3028**voor-avant-front-Vorne**

F020T605ZA75	90	5	765	900	30	25	215	115	5/20	F01
F020T601ZA75	90	5	900	765	25	25	123	115	5/20	F01
F020T477ZA75	80	4	860	860	25	25	151	96	4/22	F01.70
F020T479ZA75	80	4	860	860	30	25	205	96	4/22	F01.70
F020T553ZA75	80	4	860	860	25	25	147	96	4/22	F01.70
F020T555ZA75	80	4	860	860	30	25	220	96	4/22	F01.70

achter-arrière-rear-Hinten

F020T590ZA70	93	6	750	750	--	--	78	214	4/33+2/35	F08R
F020T536ZA70	93	5	765	765	--	--	113	165	5/31	F08R
F020T668ZA70	94	5	770	770	--	--	82	190	5/36	F08R

BESTELNR N° COMMANDE ORDER NR BESTELNR	BR LRG WID BR	BLADEN LAMES LEAVES BLATT.	B	C	D1	D2	PH FL FA SP	PAK EP TH PAK	DETAIL	MOD	OPMERKINGEN REMARQUES REMARKS BEMERKUNGEN
---	------------------------	-------------------------------------	---	---	----	----	----------------------	------------------------	--------	-----	--

SERIE : -**3033****voor-avant-front-Vorne**

A020T421ZA75	90	12	765	900	30	25	210	144	12/12	A01	
A020T419ZA75	90	12	900	765	25	25	120	144	12/12	A01	
A020T311ZB75	90	9	900	900	25	25	135	117	9/13	A01	
A020T235ZB75	90	12	900	900	25	25	200	122	2/11+10/10	A01	
A020T239ZB75	90	13	900	900	25	25	130	156	13/12	A01	
A020T235ZA75	90	12	900	900	25	25	200	122	2/11+10/10	A01.16	Vervangen
F020T605ZA75	90	5	765	900	30	25	215	115	5/20	F01	
F020T601ZA75	90	5	900	765	25	25	123	115	5/20	F01	
F020T303ZA75	90	3	900	900	25	25	163	72	3/21	F01	
F020T369ZA75	90	4	900	900	25	25	150	96	4/21	F01	
F020T297ZA75	90	3	900	900	25	25	160	75	3/22	F01.70	

achter-arrière-rear-Hinten

A020T452ZA75	100	7/4	780	620	30	30	120	148	7/12+4/16	A01B	
A020T788ZA70	94	11	750	750	--	--	80	193	6/18+5/17	A08R	
A020T514ZA70	94	11	925	925	--	--	130	189	2/18+9/17	A08R	
F020T508ZA75	100	6	620	780	30	30	85	144	6/22	F01	
F020T304ZA70	93	5	925	925	--	--	127	151	1/27+4/26	F08R	
F020T668ZA70	94	5	770	770	--	--	82	190	5/36	F08R	

BESTELNR N° COMMANDE ORDER NR BESTELNR	BR LRG WID BR	BLADEN LAMES LEAVES BLATT.	B	C	D1	D2	PH FL FA SP	PAK EP TH PAK	DETAIL	MOD	OPMERKINGEN REMARKS REMARKS BEMERKUNGEN
---	------------------------	-------------------------------------	---	---	----	----	----------------------	------------------------	--------	-----	--

SERIE : -

3036

voor-avant-front-Vorne

A020T421ZA75	90	12	765	900	30	25	210	144	12/12	A01
A020T419ZA75	90	12	900	765	25	25	120	144	12/12	A01
A020T589ZA75	90	12	900	765	25	25	78	144	12/12	A01
A020T311ZB75	90	9	900	900	25	25	135	117	9/13	A01
A020T323ZA75	90	12	900	900	25	25	90	175	7/15+5/14	A01
A020T239ZB75	90	13	900	900	25	25	130	156	13/12	A01
A020T485ZA75	90	14	900	900	25	25	65	198	2/15+12/14	A01

achter-arrière-rear-Hinten

A020T104AA70	104	11	750	750	--	--	100	176	11/16	A08R
A020T328ZA70	104	14	750	750	--	--	65	252	14/18	A08R
A020T104ZA70	104	8	770	770	--	--	60	176	8/22	A08R
A020T486ZA70	104	15	770	770	--	--	90	270	15/18	A08R
A020T306ZA70	104	14	810	810	--	--	125	300	3/23+11/21	A08R
A020T708ZA70	104	11	815	815	--	--	120	187	11/17	A08R
A020T546ZA70	104	13	820	820	--	--	118	260	13/20	A08R
A020T318ZA70	104	13	820	820	--	--	95	260	13/20	A08R
A020T506ZA70	104	16	820	820	--	--	120	336	16/21	A08R

BESTELNR N° COMMANDE ORDER NR BESTELNR	BR LRG WID BR	BLADEN LAMES LEAVES BLATT.	B	C	D1	D2	PH FL FA SP	PAK EP TH PAK	DETAIL	MOD	OPMERKINGEN REMARQUES REMARKS BEMERKUNGEN
---	------------------------	-------------------------------------	---	---	----	----	----------------------	------------------------	--------	-----	--

SERIE : -**3038****voor-avant-front-Vorne**

A020T421ZA75	90	12	765	900	30	25	210	144	12/12	A01	
A020T419ZA75	90	12	900	765	25	25	120	144	12/12	A01	
A020T235ZB75	90	12	900	900	25	25	200	122	2/11+10/10	A01	
A020T239ZB75	90	13	900	900	25	25	130	156	13/12	A01	
A020T235ZA75	90	12	900	900	25	25	200	122	2/11+10/10	A01.16	Vervangen
F020T299ZA75	90	4	900	900	25	25	166	90	1/21+3/19	F01	
F020T369ZA75	90	4	900	900	25	25	150	96	4/21	F01	
F020T297ZA75	90	3	900	900	25	25	160	75	3/22	F01.70	

achter-arrière-rear-Hinten

F020T508ZA75	100	6	620	780	30	30	85	144	6/22	F01	
--------------	-----	---	-----	-----	----	----	----	-----	------	-----	--

3228**voor-avant-front-Vorne**

F020T605ZA75	90	5	765	900	30	25	215	115	5/20	F01	
F020T601ZA75	90	5	900	765	25	25	123	115	5/20	F01	
F020T477ZA75	80	4	860	860	25	25	151	96	4/22	F01.70	
F020T479ZA75	80	4	860	860	30	25	205	96	4/22	F01.70	
F020T553ZA75	80	4	860	860	25	25	147	96	4/22	F01.70	
F020T555ZA75	80	4	860	860	30	25	220	96	4/22	F01.70	

achter-arrière-rear-Hinten

F020T590ZA70	93	6	750	750	--	--	78	214	4/33+2/35	F08R	
F020T536ZA70	93	5	765	765	--	--	113	165	5/31	F08R	
F020T668ZA70	94	5	770	770	--	--	82	190	5/36	F08R	

BESTELNR N° COMMANDE ORDER NR BESTELNR	BR LRG WID BR	BLADEN LAMES LEAVES BLATT.	B	C	D1	D2	PH FL FA SP	PAK EP TH PAK	DETAIL	MOD	OPMERKINGEN REMARQUES REMARKS BEMERKUNGEN
---	------------------------	-------------------------------------	---	---	----	----	----------------------	------------------------	--------	-----	--

SERIE : -**3229****voor-avant-front-Vorne**

F020T515ZA75	80	4	860	860	S22	S22	128	100	4/22	F01
F020T517ZA75	80	4	860	860	S22	S22	204	100	4/22	F01
F020T517ZS75	80	4/P	860	880	S22	S22	204	118	4/22+P/18	F01

achter-arrière-rear-Hinten

F020T590ZA70	93	6	750	750	--	--	78	214	4/33+2/35	F08R
--------------	----	---	-----	-----	----	----	----	-----	-----------	------

3233**voor-avant-front-Vorne**

F020T517ZA75	80	4	860	860	S22	S22	204	100	4/22	F01
F020T515ZA75	80	4	860	860	S22	S22	128	100	4/22	F01
F020T517ZS75	80	4/P	860	880	S22	S22	204	118	4/22+P/18	F01
F020T553ZA75	80	4	860	860	25	25	147	96	4/22	F01.70
F020T555ZA75	80	4	860	860	30	25	220	96	4/22	F01.70
F020T477ZA75	80	4	860	860	25	25	151	96	4/22	F01.70
F020T479ZA75	80	4	860	860	30	25	205	96	4/22	F01.70

achter-arrière-rear-Hinten

F020T590ZA70	93	6	750	750	--	--	78	214	4/33+2/35	F08R
F020T536ZA70	93	5	765	765	--	--	113	165	5/31	F08R
F020T804ZA70	94	3	750	750	--	--	75	135	3/43	F08R

BESTELNR N° COMMANDE ORDER NR BESTELNR	BR LRG WID BR	BLADEN LAMES LEAVES BLATT.	B	C	D1	D2	PH FL FA SP	PAK EP TH PAK	DETAIL	MOD	OPMERKINGEN REMARQUES REMARKS BEMERKUNGEN
---	------------------------	-------------------------------------	---	---	----	----	----------------------	------------------------	--------	-----	--

SERIE : -

3235

voor-avant-front-Vorne

A020T421ZA75	90	12	765	900	30	25	210	144	12/12	A01
A020T509ZA75	90	17	765	900	30	25	220	187	17/11	A01
A020T419ZA75	90	12	900	765	25	25	120	144	12/12	A01
A020T507ZA75	90	17	900	765	25	25	120	187	17/11	A01
F020T605ZA75	90	5	765	900	30	25	215	115	5/20	F01
F020T601ZA75	90	5	900	765	25	25	123	115	5/20	F01

achter-arrière-rear-Hinten

A020T486ZA70	104	15	770	770	--	--	90	270	15/18	A08R
A020T546ZA70	104	13	820	820	--	--	118	260	13/20	A08R
A020T506ZA70	104	16	820	820	--	--	120	336	16/21	A08R
F020T668ZA70	94	5	770	770	--	--	82	190	5/36	F08R

3236

voor-avant-front-Vorne

A020T239ZB75	90	13	900	900	25	25	130	156	13/12	A01
A020T485ZA75	90	14	900	900	25	25	65	198	2/15+12/14	A01
A020T683ZA75	90	15	900	900	25	25		212		A01

achter-arrière-rear-Hinten

A020T546ZA70	104	13	820	820	--	--	118	260	13/20	A08R
A020T506ZA70	104	16	820	820	--	--	120	336	16/21	A08R

3238

voor-avant-front-Vorne

F020T605ZA75	90	5	765	900	30	25	215	115	5/20	F01
F020T601ZA75	90	5	900	765	25	25	123	115	5/20	F01

achter-arrière-rear-Hinten

F020T668ZA70	94	5	770	770	--	--	82	190	5/36	F08R
--------------	----	---	-----	-----	----	----	----	-----	------	------

BESTELNR N° COMMANDE ORDER NR BESTELNR	BR LRG WID BR	BLADEN LAMES LEAVES BLATT.	B	C	D1	D2	PH FL FA SP	PAK EP TH PAK	DETAIL	MOD	OPMERKINGEN REMARQUES REMARKS BEMERKUNGEN
---	------------------------	-------------------------------------	---	---	----	----	----------------------	------------------------	--------	-----	--

SERIE : -**3244****voor-avant-front-Vorne**

A020T239ZB75	90	13	900	900	25	25	130	156	13/12	A01
A020T485ZA75	90	14	900	900	25	25	65	198	2/15+12/14	A01
A020T683ZA75	90	15	900	900	25	25		212		A01
F020T605ZA75	90	5	765	900	30	25	215	115	5/20	F01
F020T601ZA75	90	5	900	765	25	25	123	115	5/20	F01

achter-arrière-rear-Hinten

A020T546ZA70	104	13	820	820	--	--	118	260	13/20	A08R
A020T506ZA70	104	16	820	820	--	--	120	336	16/21	A08R
F020T696ZA70	93	5	925	925	--	--	155	151	1/27+4/26	F08R
F020T668ZA70	94	5	770	770	--	--	82	190	5/36	F08R

3250**voor-avant-front-Vorne**

A020T239ZB75	90	13	900	900	25	25	130	156	13/12	A01
A020T485ZA75	90	14	900	900	25	25	65	198	2/15+12/14	A01
A020T683ZA75	90	15	900	900	25	25		212		A01

achter-arrière-rear-Hinten

A020T546ZA70	104	13	820	820	--	--	118	260	13/20	A08R
A020T506ZA70	104	16	820	820	--	--	120	336	16/21	A08R

3328**voor-avant-front-Vorne**

A020T421ZA75	90	12	765	900	30	25	210	144	12/12	A01
A020T419ZA75	90	12	900	765	25	25	120	144	12/12	A01

achter-arrière-rear-Hinten

A020T104ZA70	104	8	770	770	--	--	60	176	8/22	A08R
A020T486ZA70	104	15	770	770	--	--	90	270	15/18	A08R

BESTELNR N° COMMANDE ORDER NR BESTELNR	BR LRG WID BR	BLADEN LAMES LEAVES BLATT.	B	C	D1	D2	PH FL FA SP	PAK EP TH PAK	DETAIL	MOD	OPMERKINGEN REMARKS BEMERKUNGEN
---	------------------------	-------------------------------------	---	---	----	----	----------------------	------------------------	--------	-----	---------------------------------------

SERIE : -**3336****voor-avant-front-Vorne**

A020T421ZA75	90	12	765	900	30	25	210	144	12/12	A01	
A020T419ZA75	90	12	900	765	25	25	120	144	12/12	A01	
A020T589ZA75	90	12	900	765	25	25	78	144	12/12	A01	
A020T311ZB75	90	9	900	900	25	25	135	117	9/13	A01	
A020T333ZA75	90	10	900	900	25	25	80	145	5/15+5/14	A01	
A020T323ZA75	90	12	900	900	25	25	90	175	7/15+5/14	A01	
A020T235ZB75	90	12	900	900	25	25	200	122	2/11+10/10	A01	
A020T239ZB75	90	13	900	900	25	25	130	156	13/12	A01	
A020T485ZA75	90	14	900	900	25	25	65	198	2/15+12/14	A01	
A020T243ZB75	90	10	900	900	25	25	80	145	5/15+5/14	A01.16	Vervangen
A020T235ZA75	90	12	900	900	25	25	200	122	2/11+10/10	A01.16	Vervangen
F020T567ZA75	90	2	750	570	30	30	-15	36	2/14	F01.70	

achter-arrière-rear-Hinten

A020T104AA70	104	11	750	750	--	--	100	176	11/16	A08R	
A020T328ZA70	104	14	750	750	--	--	65	252	14/18	A08R	
A020T104ZA70	104	8	770	770	--	--	60	176	8/22	A08R	
A020T486ZA70	104	15	770	770	--	--	90	270	15/18	A08R	
A020T306ZA70	104	14	810	810	--	--	125	300	3/23+11/21	A08R	
A020T708ZA70	104	11	815	815	--	--	120	187	11/17	A08R	
A020T546ZA70	104	13	820	820	--	--	118	260	13/20	A08R	
A020T318ZA70	104	13	820	820	--	--	95	260	13/20	A08R	
A020T506ZA70	104	16	820	820	--	--	120	336	16/21	A08R	

BESTELNR N° COMMANDE ORDER NR BESTELLNR	BR LRG WID BR	BLADEN LAMES LEAVES BLATT.	B	C	D1	D2	PH FL FA SP	PAK EP TH PAK	DETAIL	MOD	OPMERKINGEN REMARQUES REMARKS BEMERKUNGEN
--	------------------------	-------------------------------------	---	---	----	----	----------------------	------------------------	--------	-----	--

SERIE : -**3528****voor-avant-front-Vorne**

A020T421ZA75	90	12	765	900	30	25	210	144	12/12	A01
A020T419ZA75	90	12	900	765	25	25	120	144	12/12	A01

achter-arrière-rear-Hinten

A020T104ZA70	104	8	770	770	--	--	60	176	8/22	A08R
A020T486ZA70	104	15	770	770	--	--	90	270	15/18	A08R

3535**voor-avant-front-Vorne**

A020T421ZA75	90	12	765	900	30	25	210	144	12/12	A01
A020T509ZA75	90	17	765	900	30	25	220	187	17/11	A01
A020T419ZA75	90	12	900	765	25	25	120	144	12/12	A01
A020T507ZA75	90	17	900	765	25	25	120	187	17/11	A01

achter-arrière-rear-Hinten

A020T104ZA70	104	8	770	770	--	--	60	176	8/22	A08R
A020T486ZA70	104	15	770	770	--	--	90	270	15/18	A08R
A020T546ZA70	104	13	820	820	--	--	118	260	13/20	A08R
A020T506ZA70	104	16	820	820	--	--	120	336	16/21	A08R

BESTELNR N° COMMANDE ORDER NR BESTELNR	BR LRG WID BR	BLADEN LAMES LEAVES BLATT.	B	C	D1	D2	PH FL FA SP	PAK EP TH PAK	DETAIL	MOD	OPMERKINGEN REMARKS REMARKS BEMERKUNGEN
---	------------------------	-------------------------------------	---	---	----	----	----------------------	------------------------	--------	-----	--

SERIE : -

3538

voor-avant-front-Vorne

A020T421ZA75	90	12	765	900	30	25	210	144	12/12	A01
A020T509ZA75	90	17	765	900	30	25	220	187	17/11	A01
A020T419ZA75	90	12	900	765	25	25	120	144	12/12	A01
A020T507ZA75	90	17	900	765	25	25	120	187	17/11	A01
F020T605ZA75	90	5	765	900	30	25	215	115	5/20	F01
F020T689ZA75	90	5	765	900	30	25	240	115	5/20	F01
F020T687ZA75	90	5	900	765	25	25	115	115		F01
F020T601ZA75	90	5	900	765	25	25	123	115	5/20	F01
F020T369ZA75	90	4	900	900	25	25	150	96	4/21	F01

achter-arrière-rear-Hinten

A020T104ZA70	104	8	770	770	--	--	60	176	8/22	A08R
A020T486ZA70	104	15	770	770	--	--	90	270	15/18	A08R
A020T306ZA70	104	14	810	810	--	--	125	300	3/23+11/21	A08R
A020T708ZA70	104	11	815	815	--	--	120	187	11/17	A08R
A020T318ZA70	104	13	820	820	--	--	95	260	13/20	A08R
A020T546ZA70	104	13	820	820	--	--	118	260	13/20	A08R
A020T506ZA70	104	16	820	820	--	--	120	336	16/21	A08R

BESTELNR N° COMMANDE ORDER NR BESTELNR	BR LRG WID BR	BLADEN LAMES LEAVES BLATT.	B	C	D1	D2	PH FL FA SP	PAK EP TH PAK	DETAIL	MOD	OPMERKINGEN REMARKS REMARKS BEMERKUNGEN
---	------------------------	-------------------------------------	---	---	----	----	----------------------	------------------------	--------	-----	--

SERIE : -**3544****voor-avant-front-Vorne**

A020T421ZA75	90	12	765	900	30	25	210	144	12/12	A01
A020T509ZA75	90	17	765	900	30	25	220	187	17/11	A01
A020T419ZA75	90	12	900	765	25	25	120	144	12/12	A01
A020T507ZA75	90	17	900	765	25	25	120	187	17/11	A01
F020T689ZA75	90	5	765	900	30	25	240	115	5/20	F01
F020T605ZA75	90	5	765	900	30	25	215	115	5/20	F01
F020T687ZA75	90	5	900	765	25	25	115	115		F01
F020T601ZA75	90	5	900	765	25	25	123	115	5/20	F01

achter-arrière-rear-Hinten

A020T104ZA70	104	8	770	770	--	--	60	176	8/22	A08R
A020T486ZA70	104	15	770	770	--	--	90	270	15/18	A08R
A020T306ZA70	104	14	810	810	--	--	125	300	3/23+11/21	A08R
A020T708ZA70	104	11	815	815	--	--	120	187	11/17	A08R
A020T546ZA70	104	13	820	820	--	--	118	260	13/20	A08R
A020T318ZA70	104	13	820	820	--	--	95	260	13/20	A08R
A020T506ZA70	104	16	820	820	--	--	120	336	16/21	A08R

BESTELNR N° COMMANDE ORDER NR BESTELLNR	BR LRG WID BR	BLADEN LAMES LEAVES BLATT.	B	C	D1	D2	PH FL FA SP	PAK EP TH PAK	DETAIL	MOD	OPMERKINGEN REMARKES REMARKS BEMERKUNGEN
--	------------------------	-------------------------------------	---	---	----	----	----------------------	------------------------	--------	-----	---

SERIE : -**3548****voor-avant-front-Vorne**

A020T421ZA75	90	12	765	900	30	25	210	144	12/12	A01
A020T509ZA75	90	17	765	900	30	25	220	187	17/11	A01
A020T419ZA75	90	12	900	765	25	25	120	144	12/12	A01
A020T507ZA75	90	17	900	765	25	25	120	187	17/11	A01
F020T605ZA75	90	5	765	900	30	25	215	115	5/20	F01
F020T601ZA75	90	5	900	765	25	25	123	115	5/20	F01
F020T369ZA75	90	4	900	900	25	25	150	96	4/21	F01
F020T567ZA75	90	2	750	570	30	30	-15	36	2/14	F01.70

achter-arrière-rear-Hinten

A020T104ZA70	104	8	770	770	--	--	60	176	8/22	A08R
A020T486ZA70	104	15	770	770	--	--	90	270	15/18	A08R
A020T306ZA70	104	14	810	810	--	--	125	300	3/23+11/21	A08R
A020T546ZA70	104	13	820	820	--	--	118	260	13/20	A08R
A020T318ZA70	104	13	820	820	--	--	95	260	13/20	A08R
A020T506ZA70	104	16	820	820	--	--	120	336	16/21	A08R
F020T692ZA70	104	4	765	765	--	--	40	152	4/36	F08R

BESTELNR N° COMMANDE ORDER NR BESTELNR	BR LRG WID BR	BLADEN LAMES LEAVES BLATT.	B	C	D1	D2	PH FL FA SP	PAK EP TH PAK	DETAIL	MOD	OPMERKINGEN REMARQUES REMARKS BEMERKUNGEN
---	------------------------	-------------------------------------	---	---	----	----	----------------------	------------------------	--------	-----	--

SERIE : -**3550****voor-avant-front-Vorne**

A020T421ZA75	90	12	765	900	30	25	210	144	12/12		A01
A020T509ZA75	90	17	765	900	30	25	220	187	17/11		A01
A020T589ZA75	90	12	900	765	25	25	78	144	12/12		A01
A020T419ZA75	90	12	900	765	25	25	120	144	12/12		A01
A020T507ZA75	90	17	900	765	25	25	120	187	17/11		A01
A020T485ZA75	90	14	900	900	25	25	65	198	2/15+12/14		A01
F020T605ZA75	90	5	765	900	30	25	215	115	5/20		F01
F020T689ZA75	90	5	765	900	30	25	240	115	5/20		F01
F020T601ZA75	90	5	900	765	25	25	123	115	5/20		F01
F020T687ZA75	90	5	900	765	25	25	115	115			F01
F020T369ZA75	90	4	900	900	25	25	150	96	4/21		F01
F020T567ZA75	90	2	750	570	30	30	-15	36	2/14		F01.70

achter-arrière-rear-Hinten

A020T104ZA70	104	8	770	770	--	--	60	176	8/22		A08R
A020T486ZA70	104	15	770	770	--	--	90	270	15/18		A08R
A020T706ZA70	104	15	775	775	--	--	115	304	4/21+11/20		A08R
A020T306ZA70	104	14	810	810	--	--	125	300	3/23+11/21		A08R
A020T708ZA70	104	11	815	815	--	--	120	187	11/17		A08R
A020T546ZA70	104	13	820	820	--	--	118	260	13/20		A08R
A020T318ZA70	104	13	820	820	--	--	95	260	13/20		A08R
A020T506ZA70	104	16	820	820	--	--	120	336	16/21		A08R
F020T692ZA70	104	4	765	765	--	--	40	152	4/36		F08R

BESTELNR N° COMMANDE ORDER NR BESTELNR	BR LRG WID BR	BLADEN LAMES LEAVES BLATT.	B	C	D1	D2	PH FL FA SP	PAK EP TH PAK	DETAIL	MOD	OPMERKINGEN REMARQUES REMARKS BEMERKUNGEN
---	------------------------	-------------------------------------	---	---	----	----	----------------------	------------------------	--------	-----	--

SERIE : -**3850****voor-avant-front-Vorne**

A020T239ZB75	90	13	900	900	25	25	130	156	13/12	A01
A020T485ZA75	90	14	900	900	25	25	65	198	2/15+12/14	A01
A020T683ZA75	90	15	900	900	25	25		212		A01

achter-arrière-rear-Hinten

A020T306ZA70	104	14	810	810	--	--	125	300	3/23+11/21	A08R
A020T506ZA70	104	16	820	820	--	--	120	336	16/21	A08R

4050**voor-avant-front-Vorne**

A020T685ZA75	90	17	0	0	25	25		0		A01
A020T679ZA75	90	15	900	900	25	25		165	11/15	A01
A020T681ZA75	90	15	900	900	25	25		165	11/15	A01
F020T369ZA75	90	4	900	900	25	25	150	96	4/21	F01

achter-arrière-rear-Hinten

A020T708ZA70	104	11	815	815	--	--	120	187	11/17	A08R
A020T546ZA70	104	13	820	820	--	--	118	260	13/20	A08R
A020T506ZA70	104	16	820	820	--	--	120	336	16/21	A08R

4850**voor-avant-front-Vorne**

A020T685ZA75	90	17	0	0	25	25		0		A01
A020T681ZA75	90	15	900	900	25	25		165	11/15	A01
A020T679ZA75	90	15	900	900	25	25		165	11/15	A01

achter-arrière-rear-Hinten

A020T506ZA70	104	16	820	820	--	--	120	336	16/21	A08R
--------------	-----	----	-----	-----	----	----	-----	-----	-------	------

BESTELNR N° COMMANDE ORDER NR BESTELNR	BR LRG WID BR	BLADEN LAMES LEAVES BLATT.	B	C	D1	D2	PH FL FA SP	PAK EP TH PAK	DETAIL	MOD	OPMERKINGEN REMARQUES REMARKS BEMERKUNGEN
---	------------------------	-------------------------------------	---	---	----	----	----------------------	------------------------	--------	-----	--

SERIE : ACTROS

1823

voor-avant-front-Vorne

F020T669ZA75	90	2	900	900	S24	S24	116	62	2/28	F01
F020T637ZA75	90	3	900	900	S24	S24	150	77	1/22+2/23	F01
F020T647ZA75	90	3	900	900	S24	S24	142	86	1/25+2/26	F01
F020T649ZA75	90	3	900	900	S24	S24	140	81	1/22+2/25	F01
F020T659ZA75	90	3	900	900	S24	S24	160	79	1/22+2/24	F01
F020T709ZA75	90	2	900	900	S24	S24	121	58	2/27	F01.10
F020T711ZA75	90	2	900	900	S24	S24	123	60	2/28	F01.10

BESTELNR N° COMMANDE ORDER NR BESTELNR	BR LRG WID BR	BLADEN LAMES LEAVES BLATT.	B	C	D1	D2	PH FL FA SP	PAK EP TH PAK	DETAIL	MOD	OPMERKINGEN REMARQUES REMARKS BEMERKUNGEN
---	------------------------	-------------------------------------	---	---	----	----	----------------------	------------------------	--------	-----	--

SERIE : ACTROS**1831****voor-avant-front-Vorne**

F020T669ZA75	90	2	900	900	S24	S24	116	62	2/28	F01
F020T671ZA75	90	3	900	900	S24	S24	102	92	1/28+2/29	F01
F020T667ZA75	90	3	900	900	S24	S24		79		F01
F020T665ZA75	90	3	900	900	S24	S24	122	78	1/22+2/25	F01
F020T637ZA75	90	3	900	900	S24	S24	150	77	1/22+2/23	F01
F020T647ZA75	90	3	900	900	S24	S24	142	86	1/25+2/26	F01
F020T649ZA75	90	3	900	900	S24	S24	140	81	1/22+2/25	F01
F020T659ZA75	90	3	900	900	S24	S24	160	79	1/22+2/24	F01
F020T661ZA75	90	3	900	900	S24	S24	140	77		F01
F020T663ZA75	90	3	900	900	S24	S24	130	80	1/24+2/25	F01
F020T731ZA75	90	3	970	830	S24	S24	94	90	3/28	F01
F020T713ZA75	90	3	970	830	S24	S24		81	1/23+2/25	F01
F020T709ZA75	90	2	900	900	S24	S24	121	58	2/27	F01.10
F020T711ZA75	90	2	900	900	S24	S24	123	60	2/28	F01.10

achter-arrière-rear-Hinten

F020T766ZA75	100	5	900	750	S24	S24		133	1/23+4/25	F01
F020T760ZA75	100	2/1	900	885	S24	S24	117	99	1/28+1/30+1/35	F01B
F020T762ZA75	100	3/1	900	885	S24	S24	108	127	1/23+2/28+1/40	F01B
F020T764ZA75	100	3/1	900	885	S24	S24	90	133	1/23+2/28+1/46	F01B
F020T774ZA70	100	4	780	780	--	--	55	160	4/37	F08R
F020T772ZA70	100	4	780	780	--	--	80	144	4/33	F08R
F020T792ZA70	100	3	830	830	--	--	82	129	3/40	F08R

BESTELNR N° COMMANDE ORDER NR BESTELNR	BR LRG WID BR	BLADEN LAMES LEAVES BLATT.	B	C	D1	D2	PH FL FA SP	PAK EP TH PAK	DETAIL	MOD	OPMERKINGEN REMARQUES REMARKS BEMERKUNGEN
---	------------------------	-------------------------------------	---	---	----	----	----------------------	------------------------	--------	-----	--

SERIE : ACTROS

1835

voor-avant-front-Vorne

F020T669ZA75	90	2	900	900	S24	S24	116	62	2/28	F01
F020T637ZA75	90	3	900	900	S24	S24	150	77	1/22+2/23	F01
F020T671ZA75	90	3	900	900	S24	S24	102	92	1/28+2/29	F01
F020T649ZA75	90	3	900	900	S24	S24	140	81	1/22+2/25	F01
F020T659ZA75	90	3	900	900	S24	S24	160	79	1/22+2/24	F01
F020T647ZA75	90	3	900	900	S24	S24	142	86	1/25+2/26	F01
F020T665ZA75	90	3	900	900	S24	S24	122	78	1/22+2/25	F01
F020T667ZA75	90	3	900	900	S24	S24		79		F01
F020T661ZA75	90	3	900	900	S24	S24	140	77		F01
F020T713ZA75	90	3	970	830	S24	S24		81	1/23+2/25	F01
F020T731ZA75	90	3	970	830	S24	S24	94	90	3/28	F01
F020T709ZA75	90	2	900	900	S24	S24	121	58	2/27	F01.10
F020T711ZA75	90	2	900	900	S24	S24	123	60	2/28	F01.10

achter-arrière-rear-Hinten

F020T766ZA75	100	5	900	750	S24	S24		133	1/23+4/25	F01
F020T760ZA75	100	2/1	900	885	S24	S24	117	99	1/28+1/30+1/35	F01B
F020T762ZA75	100	3/1	900	885	S24	S24	108	127	1/23+2/28+1/40	F01B
F020T764ZA75	100	3/1	900	885	S24	S24	90	133	1/23+2/28+1/46	F01B
F020T774ZA70	100	4	780	780	--	--	55	160	4/37	F08R
F020T772ZA70	100	4	780	780	--	--	80	144	4/33	F08R
F020T792ZA70	100	3	830	830	--	--	82	129	3/40	F08R

BESTELNR N° COMMANDE ORDER NR BESTELNR	BR LRG WID BR	BLADEN LAMES LEAVES BLATT.	B	C	D1	D2	PH FL FA SP	PAK EP TH PAK	DETAIL	MOD	OPMERKINGEN REMARQUES REMARKS BEMERKUNGEN
---	------------------------	-------------------------------------	---	---	----	----	----------------------	------------------------	--------	-----	--

SERIE : ACTROS**1840****voor-avant-front-Vorne**

F020T669ZA75	90	2	900	900	S24	S24	116	62	2/28	F01
F020T649ZA75	90	3	900	900	S24	S24	140	81	1/22+2/25	F01
F020T663ZA75	90	3	900	900	S24	S24	130	80	1/24+2/25	F01
F020T665ZA75	90	3	900	900	S24	S24	122	78	1/22+2/25	F01
F020T671ZA75	90	3	900	900	S24	S24	102	92	1/28+2/29	F01
F020T661ZA75	90	3	900	900	S24	S24	140	77		F01
F020T659ZA75	90	3	900	900	S24	S24	160	79	1/22+2/24	F01
F020T637ZA75	90	3	900	900	S24	S24	150	77	1/22+2/23	F01
F020T667ZA75	90	3	900	900	S24	S24		79		F01
F020T647ZA75	90	3	900	900	S24	S24	142	86	1/25+2/26	F01
F020T713ZA75	90	3	970	830	S24	S24		81	1/23+2/25	F01
F020T731ZA75	90	3	970	830	S24	S24	94	90	3/28	F01
F020T709ZA75	90	2	900	900	S24	S24	121	58	2/27	F01.10
F020T711ZA75	90	2	900	900	S24	S24	123	60	2/28	F01.10

achter-arrière-rear-Hinten

F020T760ZA75	100	2/1	900	885	S24	S24	117	99	1/28+1/30+1/35	F01B
F020T762ZA75	100	3/1	900	885	S24	S24	108	127	1/23+2/28+1/40	F01B
F020T764ZA75	100	3/1	900	885	S24	S24	90	133	1/23+2/28+1/46	F01B
F020T772ZA70	100	4	780	780	--	--	80	144	4/33	F08R
F020T774ZA70	100	4	780	780	--	--	55	160	4/37	F08R
F020T792ZA70	100	3	830	830	--	--	82	129	3/40	F08R

BESTELNR N° COMMANDE ORDER NR BESTELNR	BR LRG WID BR	BLADEN LAMES LEAVES BLATT.	B	C	D1	D2	PH FL FA SP	PAK EP TH PAK	DETAIL	MOD	OPMERKINGEN REMARQUES REMARKS BEMERKUNGEN
---	------------------------	-------------------------------------	---	---	----	----	----------------------	------------------------	--------	-----	--

SERIE : ACTROS**1843****voor-avant-front-Vorne**

F020T669ZA75	90	2	900	900	S24	S24	116	62	2/28	F01
F020T647ZA75	90	3	900	900	S24	S24	142	86	1/25+2/26	F01
F020T667ZA75	90	3	900	900	S24	S24		79		F01
F020T665ZA75	90	3	900	900	S24	S24	122	78	1/22+2/25	F01
F020T661ZA75	90	3	900	900	S24	S24	140	77		F01
F020T659ZA75	90	3	900	900	S24	S24	160	79	1/22+2/24	F01
F020T649ZA75	90	3	900	900	S24	S24	140	81	1/22+2/25	F01
F020T637ZA75	90	3	900	900	S24	S24	150	77	1/22+2/23	F01
F020T671ZA75	90	3	900	900	S24	S24	102	92	1/28+2/29	F01
F020T713ZA75	90	3	970	830	S24	S24		81	1/23+2/25	F01
F020T731ZA75	90	3	970	830	S24	S24	94	90	3/28	F01
F020T709ZA75	90	2	900	900	S24	S24	121	58	2/27	F01.10
F020T711ZA75	90	2	900	900	S24	S24	123	60	2/28	F01.10

achter-arrière-rear-Hinten

F020T760ZA75	100	2/1	900	885	S24	S24	117	99	1/28+1/30+1/35	F01B
F020T762ZA75	100	3/1	900	885	S24	S24	108	127	1/23+2/28+1/40	F01B
F020T764ZA75	100	3/1	900	885	S24	S24	90	133	1/23+2/28+1/46	F01B
F020T772ZA70	100	4	780	780	--	--	80	144	4/33	F08R
F020T774ZA70	100	4	780	780	--	--	55	160	4/37	F08R
F020T792ZA70	100	3	830	830	--	--	82	129	3/40	F08R

BESTELNR N° COMMANDE ORDER NR BESTELNR	BR LRG WID BR	BLADEN LAMES LEAVES BLATT.	B	C	D1	D2	PH FL FA SP	PAK EP TH PAK	DETAIL	MOD	OPMERKINGEN REMARQUES REMARKS BEMERKUNGEN
---	------------------------	-------------------------------------	---	---	----	----	----------------------	------------------------	--------	-----	--

SERIE : ACTROS**1848****voor-avant-front-Vorne**

F020T669ZA75	90	2	900	900	S24	S24	116	62	2/28	F01
F020T649ZA75	90	3	900	900	S24	S24	140	81	1/22+2/25	F01
F020T647ZA75	90	3	900	900	S24	S24	142	86	1/25+2/26	F01
F020T637ZA75	90	3	900	900	S24	S24	150	77	1/22+2/23	F01
F020T665ZA75	90	3	900	900	S24	S24	122	78	1/22+2/25	F01
F020T667ZA75	90	3	900	900	S24	S24		79		F01
F020T659ZA75	90	3	900	900	S24	S24	160	79	1/22+2/24	F01
F020T671ZA75	90	3	900	900	S24	S24	102	92	1/28+2/29	F01
F020T713ZA75	90	3	970	830	S24	S24		81	1/23+2/25	F01
F020T731ZA75	90	3	970	830	S24	S24	94	90	3/28	F01
F020T711ZA75	90	2	900	900	S24	S24	123	60	2/28	F01.10
F020T709ZA75	90	2	900	900	S24	S24	121	58	2/27	F01.10

achter-arrière-rear-Hinten

F020T760ZA75	100	2/1	900	885	S24	S24	117	99	1/28+1/30+1/35	F01B
F020T762ZA75	100	3/1	900	885	S24	S24	108	127	1/23+2/28+1/40	F01B
F020T764ZA75	100	3/1	900	885	S24	S24	90	133	1/23+2/28+1/46	F01B
F020T772ZA70	100	4	780	780	--	--	80	144	4/33	F08R
F020T774ZA70	100	4	780	780	--	--	55	160	4/37	F08R
F020T792ZA70	100	3	830	830	--	--	82	129	3/40	F08R

BESTELNR N° COMMANDE ORDER NR BESTELNR	BR LRG WID BR	BLADEN LAMES LEAVES BLATT.	B	C	D1	D2	PH FL FA SP	PAK EP TH PAK	DETAIL	MOD	OPMERKINGEN REMARQUES REMARKS BEMERKUNGEN
---	------------------------	-------------------------------------	---	---	----	----	----------------------	------------------------	--------	-----	--

SERIE : ACTROS**1853****voor-avant-front-Vorne**

F020T647ZA75	90	3	900	900	S24	S24	142	86	1/25+2/26	F01
F020T671ZA75	90	3	900	900	S24	S24	102	92	1/28+2/29	F01
F020T659ZA75	90	3	900	900	S24	S24	160	79	1/22+2/24	F01
F020T649ZA75	90	3	900	900	S24	S24	140	81	1/22+2/25	F01
F020T713ZA75	90	3	970	830	S24	S24		81	1/23+2/25	F01
F020T731ZA75	90	3	970	830	S24	S24	94	90	3/28	F01
F020T711ZA75	90	2	900	900	S24	S24	123	60	2/28	F01.10

achter-arrière-rear-Hinten

F020T774ZA70	100	4	780	780	--	--	55	160	4/37	F08R
F020T772ZA70	100	4	780	780	--	--	80	144	4/33	F08R
F020T792ZA70	100	3	830	830	--	--	82	129	3/40	F08R

2031**voor-avant-front-Vorne**

F020T659ZA75	90	3	900	900	S24	S24	160	79	1/22+2/24	F01
F020T671ZA75	90	3	900	900	S24	S24	102	92	1/28+2/29	F01
F020T663ZA75	90	3	900	900	S24	S24	130	80	1/24+2/25	F01
F020T649ZA75	90	3	900	900	S24	S24	140	81	1/22+2/25	F01
F020T647ZA75	90	3	900	900	S24	S24	142	86	1/25+2/26	F01
F020T667ZA75	90	3	900	900	S24	S24		79		F01
F020T713ZA75	90	3	970	830	S24	S24		81	1/23+2/25	F01
F020T731ZA75	90	3	970	830	S24	S24	94	90	3/28	F01
F020T711ZA75	90	2	900	900	S24	S24	123	60	2/28	F01.10

achter-arrière-rear-Hinten

F020T764ZA75	100	3/1	900	885	S24	S24	90	133	1/23+2/28+1/46	F01B
F020T762ZA75	100	3/1	900	885	S24	S24	108	127	1/23+2/28+1/40	F01B

BESTELNR N° COMMANDE ORDER NR BESTELNR	BR LRG WID BR	BLADEN LAMES LEAVES BLATT.	B	C	D1	D2	PH FL FA SP	PAK EP TH PAK	DETAIL	MOD	OPMERKINGEN REMARKS REMARKS BEMERKUNGEN
---	------------------------	-------------------------------------	---	---	----	----	----------------------	------------------------	--------	-----	--

SERIE : ACTROS

2035

voor-avant-front-Vorne

F020T671ZA75	90	3	900	900	S24	S24	102	92	1/28+2/29	F01
F020T647ZA75	90	3	900	900	S24	S24	142	86	1/25+2/26	F01
F020T649ZA75	90	3	900	900	S24	S24	140	81	1/22+2/25	F01
F020T663ZA75	90	3	900	900	S24	S24	130	80	1/24+2/25	F01
F020T667ZA75	90	3	900	900	S24	S24		79		F01
F020T713ZA75	90	3	970	830	S24	S24		81	1/23+2/25	F01
F020T731ZA75	90	3	970	830	S24	S24	94	90	3/28	F01

achter-arrière-rear-Hinten

F020T762ZA75	100	3/1	900	885	S24	S24	108	127	1/23+2/28+1/40	F01B
F020T764ZA75	100	3/1	900	885	S24	S24	90	133	1/23+2/28+1/46	F01B

2040

voor-avant-front-Vorne

F020T647ZA75	90	3	900	900	S24	S24	142	86	1/25+2/26	F01
F020T649ZA75	90	3	900	900	S24	S24	140	81	1/22+2/25	F01
F020T659ZA75	90	3	900	900	S24	S24	160	79	1/22+2/24	F01
F020T663ZA75	90	3	900	900	S24	S24	130	80	1/24+2/25	F01
F020T671ZA75	90	3	900	900	S24	S24	102	92	1/28+2/29	F01
F020T713ZA75	90	3	970	830	S24	S24		81	1/23+2/25	F01
F020T731ZA75	90	3	970	830	S24	S24	94	90	3/28	F01
F020T711ZA75	90	2	900	900	S24	S24	123	60	2/28	F01.10

achter-arrière-rear-Hinten

F020T764ZA75	100	3/1	900	885	S24	S24	90	133	1/23+2/28+1/46	F01B
F020T762ZA75	100	3/1	900	885	S24	S24	108	127	1/23+2/28+1/40	F01B

BESTELNR N° COMMANDE ORDER NR BESTELNR	BR LRG WID BR	BLADEN LAMES LEAVES BLATT.	B	C	D1	D2	PH FL FA SP	PAK EP TH PAK	DETAIL	MOD	OPMERKINGEN REMARQUES REMARKS BEMERKUNGEN
---	------------------------	-------------------------------------	---	---	----	----	----------------------	------------------------	--------	-----	--

SERIE : ACTROS

2053

voor-avant-front-Vorne

F020T647ZA75	90	3	900	900	S24	S24	142	86	1/25+2/26	F01
F020T659ZA75	90	3	900	900	S24	S24	160	79	1/22+2/24	F01
F020T649ZA75	90	3	900	900	S24	S24	140	81	1/22+2/25	F01
F020T713ZA75	90	3	970	830	S24	S24		81	1/23+2/25	F01
F020T731ZA75	90	3	970	830	S24	S24	94	90	3/28	F01
F020T711ZA75	90	2	900	900	S24	S24	123	60	2/28	F01.10

achter-arrière-rear-Hinten

F020T762ZA75	100	3/1	900	885	S24	S24	108	127	1/23+2/28+1/40	F01B
F020T764ZA75	100	3/1	900	885	S24	S24	90	133	1/23+2/28+1/46	F01B

2523

voor-avant-front-Vorne

F020T637ZA75	90	3	900	900	S24	S24	150	77	1/22+2/23	F01
F020T649ZA75	90	3	900	900	S24	S24	140	81	1/22+2/25	F01
F020T659ZA75	90	3	900	900	S24	S24	160	79	1/22+2/24	F01

2528

voor-avant-front-Vorne

F020T669ZA75	90	2	900	900	S24	S24	116	62	2/28	F01
F020T637ZA75	90	3	900	900	S24	S24	150	77	1/22+2/23	F01
F020T647ZA75	90	3	900	900	S24	S24	142	86	1/25+2/26	F01
F020T649ZA75	90	3	900	900	S24	S24	140	81	1/22+2/25	F01
F020T659ZA75	90	3	900	900	S24	S24	160	79	1/22+2/24	F01
F020T709ZA75	90	2	900	900	S24	S24	121	58	2/27	F01.10
F020T711ZA75	90	2	900	900	S24	S24	123	60	2/28	F01.10

BESTELNR N° COMMANDE ORDER NR BESTELLNR	BR LRG WID BR	BLADEN LAMES LEAVES BLATT.	B	C	D1	D2	PH FL FA SP	PAK EP TH PAK	DETAIL	MOD	OPMERKINGEN REMARQUES REMARKS BEMERKUNGEN
--	------------------------	-------------------------------------	---	---	----	----	----------------------	------------------------	--------	-----	--

SERIE : ACTROS**2531****voor-avant-front-Vorne**

F020T669ZA75	90	2	900	900	S24	S24	116	62	2/28	F01
F020T637ZA75	90	3	900	900	S24	S24	150	77	1/22+2/23	F01
F020T647ZA75	90	3	900	900	S24	S24	142	86	1/25+2/26	F01
F020T649ZA75	90	3	900	900	S24	S24	140	81	1/22+2/25	F01
F020T659ZA75	90	3	900	900	S24	S24	160	79	1/22+2/24	F01
F020T663ZA75	90	3	900	900	S24	S24	130	80	1/24+2/25	F01
F020T711ZA75	90	2	900	900	S24	S24	123	60	2/28	F01.10
F020T709ZA75	90	2	900	900	S24	S24	121	58	2/27	F01.10

achter-arrière-rear-Hinten

F020T730ZA75	100	6	800	620	S24	S24	19	150	1/24+5/22	F01
F020T910ZA75	100	8	800	620	S24	S24	82/29	166	1/23+7/19	F01

2535**voor-avant-front-Vorne**

F020T669ZA75	90	2	900	900	S24	S24	116	62	2/28	F01
F020T663ZA75	90	3	900	900	S24	S24	130	80	1/24+2/25	F01
F020T659ZA75	90	3	900	900	S24	S24	160	79	1/22+2/24	F01
F020T649ZA75	90	3	900	900	S24	S24	140	81	1/22+2/25	F01
F020T637ZA75	90	3	900	900	S24	S24	150	77	1/22+2/23	F01
F020T647ZA75	90	3	900	900	S24	S24	142	86	1/25+2/26	F01
F020T709ZA75	90	2	900	900	S24	S24	121	58	2/27	F01.10
F020T711ZA75	90	2	900	900	S24	S24	123	60	2/28	F01.10

BESTELNR N° COMMANDE ORDER NR BESTELNR	BR LRG WID BR	BLADEN LAMES LEAVES BLATT.	B	C	D1	D2	PH FL FA SP	PAK EP TH PAK	DETAIL	MOD	OPMERKINGEN REMARQUES REMARKS BEMERKUNGEN
---	------------------------	-------------------------------------	---	---	----	----	----------------------	------------------------	--------	-----	--

SERIE : ACTROS**2540****voor-avant-front-Vorne**

F020T669ZA75	90	2	900	900	S24	S24	116	62	2/28	F01
F020T649ZA75	90	3	900	900	S24	S24	140	81	1/22+2/25	F01
F020T663ZA75	90	3	900	900	S24	S24	130	80	1/24+2/25	F01
F020T659ZA75	90	3	900	900	S24	S24	160	79	1/22+2/24	F01
F020T637ZA75	90	3	900	900	S24	S24	150	77	1/22+2/23	F01
F020T647ZA75	90	3	900	900	S24	S24	142	86	1/25+2/26	F01
F020T709ZA75	90	2	900	900	S24	S24	121	58	2/27	F01.10
F020T711ZA75	90	2	900	900	S24	S24	123	60	2/28	F01.10

achter-arrière-rear-Hinten

F020T730ZA75	100	6	800	620	S24	S24	19	150	1/24+5/22	F01
F020T910ZA75	100	8	800	620	S24	S24	82/29	166	1/23+7/19	F01

2543**voor-avant-front-Vorne**

F020T669ZA75	90	2	900	900	S24	S24	116	62	2/28	F01
F020T637ZA75	90	3	900	900	S24	S24	150	77	1/22+2/23	F01
F020T647ZA75	90	3	900	900	S24	S24	142	86	1/25+2/26	F01
F020T649ZA75	90	3	900	900	S24	S24	140	81	1/22+2/25	F01
F020T659ZA75	90	3	900	900	S24	S24	160	79	1/22+2/24	F01
F020T663ZA75	90	3	900	900	S24	S24	130	80	1/24+2/25	F01
F020T709ZA75	90	2	900	900	S24	S24	121	58	2/27	F01.10
F020T711ZA75	90	2	900	900	S24	S24	123	60	2/28	F01.10

achter-arrière-rear-Hinten

F020T730ZA75	100	6	800	620	S24	S24	19	150	1/24+5/22	F01
F020T910ZA75	100	8	800	620	S24	S24	82/29	166	1/23+7/19	F01

BESTELNR N° COMMANDE ORDER NR BESTELNR	BR LRG WID BR	BLADEN LAMES LEAVES BLATT.	B	C	D1	D2	PH FL FA SP	PAK EP TH PAK	DETAIL	MOD	OPMERKINGEN REMARQUES REMARKS BEMERKUNGEN
---	------------------------	-------------------------------------	---	---	----	----	----------------------	------------------------	--------	-----	--

SERIE : ACTROS**2548****voor-avant-front-Vorne**

F020T669ZA75	90	2	900	900	S24	S24	116	62	2/28	F01
F020T659ZA75	90	3	900	900	S24	S24	160	79	1/22+2/24	F01
F020T649ZA75	90	3	900	900	S24	S24	140	81	1/22+2/25	F01
F020T647ZA75	90	3	900	900	S24	S24	142	86	1/25+2/26	F01
F020T637ZA75	90	3	900	900	S24	S24	150	77	1/22+2/23	F01
F020T663ZA75	90	3	900	900	S24	S24	130	80	1/24+2/25	F01
F020T709ZA75	90	2	900	900	S24	S24	121	58	2/27	F01.10
F020T711ZA75	90	2	900	900	S24	S24	123	60	2/28	F01.10

achter-arrière-rear-Hinten

F020T730ZA75	100	6	800	620	S24	S24	19	150	1/24+5/22	F01
F020T910ZA75	100	8	800	620	S24	S24	82/29	166	1/23+7/19	F01

2553**voor-avant-front-Vorne**

F020T669ZA75	90	2	900	900	S24	S24	116	62	2/28	F01
F020T637ZA75	90	3	900	900	S24	S24	150	77	1/22+2/23	F01
F020T663ZA75	90	3	900	900	S24	S24	130	80	1/24+2/25	F01
F020T659ZA75	90	3	900	900	S24	S24	160	79	1/22+2/24	F01
F020T649ZA75	90	3	900	900	S24	S24	140	81	1/22+2/25	F01
F020T647ZA75	90	3	900	900	S24	S24	142	86	1/25+2/26	F01
F020T709ZA75	90	2	900	900	S24	S24	121	58	2/27	F01.10
F020T711ZA75	90	2	900	900	S24	S24	123	60	2/28	F01.10

achter-arrière-rear-Hinten

F020T730ZA75	100	6	800	620	S24	S24	19	150	1/24+5/22	F01
F020T910ZA75	100	8	800	620	S24	S24	82/29	166	1/23+7/19	F01

BESTELNR N° COMMANDE ORDER NR BESTELNR	BR LRG WID BR	BLADEN LAMES LEAVES BLATT.	B	C	D1	D2	PH FL FA SP	PAK EP TH PAK	DETAIL	MOD	OPMERKINGEN REMARQUES REMARKS BEMERKUNGEN
---	------------------------	-------------------------------------	---	---	----	----	----------------------	------------------------	--------	-----	--

SERIE : ACTROS

2628

voor-avant-front-Vorne

F020T647ZA75	90	3	900	900	S24	S24	142	86	1/25+2/26	F01
F020T671ZA75	90	3	900	900	S24	S24	102	92	1/28+2/29	F01
F020T665ZA75	90	3	900	900	S24	S24	122	78	1/22+2/25	F01
F020T649ZA75	90	3	900	900	S24	S24	140	81	1/22+2/25	F01
F020T663ZA75	90	3	900	900	S24	S24	130	80	1/24+2/25	F01

achter-arrière-rear-Hinten

F020T776ZA70	100	2/1	780	780	--	--	53	131	2/37+1/49	F08RB
--------------	-----	-----	-----	-----	----	----	----	-----	-----------	-------

2631

voor-avant-front-Vorne

F020T669ZA75	90	2	900	900	S24	S24	116	62	2/28	F01
F020T663ZA75	90	3	900	900	S24	S24	130	80	1/24+2/25	F01
F020T637ZA75	90	3	900	900	S24	S24	150	77	1/22+2/23	F01
F020T671ZA75	90	3	900	900	S24	S24	102	92	1/28+2/29	F01
F020T665ZA75	90	3	900	900	S24	S24	122	78	1/22+2/25	F01
F020T659ZA75	90	3	900	900	S24	S24	160	79	1/22+2/24	F01
F020T649ZA75	90	3	900	900	S24	S24	140	81	1/22+2/25	F01
F020T647ZA75	90	3	900	900	S24	S24	142	86	1/25+2/26	F01
F020T709ZA75	90	2	900	900	S24	S24	121	58	2/27	F01.10
F020T711ZA75	90	2	900	900	S24	S24	123	60	2/28	F01.10

achter-arrière-rear-Hinten

F020T776ZA70	100	2/1	780	780	--	--	53	131	2/37+1/49	F08RB
F020T770ZA70	100	4/1	780	780	--	--	132	138	4/23+1/31	F08RB

BESTELNR N° COMMANDE ORDER NR BESTELNR	BR LRG WID BR	BLADEN LAMES LEAVES BLATT.	B	C	D1	D2	PH FL FA SP	PAK EP TH PAK	DETAIL	MOD	OPMERKINGEN REMARQUES REMARKS BEMERKUNGEN
---	------------------------	-------------------------------------	---	---	----	----	----------------------	------------------------	--------	-----	--

SERIE : ACTROS**2635****voor-avant-front-Vorne**

F020T669ZA75	90	2	900	900	S24	S24	116	62	2/28	F01
F020T663ZA75	90	3	900	900	S24	S24	130	80	1/24+2/25	F01
F020T637ZA75	90	3	900	900	S24	S24	150	77	1/22+2/23	F01
F020T665ZA75	90	3	900	900	S24	S24	122	78	1/22+2/25	F01
F020T671ZA75	90	3	900	900	S24	S24	102	92	1/28+2/29	F01
F020T649ZA75	90	3	900	900	S24	S24	140	81	1/22+2/25	F01
F020T647ZA75	90	3	900	900	S24	S24	142	86	1/25+2/26	F01
F020T659ZA75	90	3	900	900	S24	S24	160	79	1/22+2/24	F01
F020T709ZA75	90	2	900	900	S24	S24	121	58	2/27	F01.10
F020T711ZA75	90	2	900	900	S24	S24	123	60	2/28	F01.10

achter-arrière-rear-Hinten

F020T776ZA70	100	2/1	780	780	--	--	53	131	2/37+1/49	F08RB
F020T770ZA70	100	4/1	780	780	--	--	132	138	4/23+1/31	F08RB

2640**voor-avant-front-Vorne**

F020T669ZA75	90	2	900	900	S24	S24	116	62	2/28	F01
F020T649ZA75	90	3	900	900	S24	S24	140	81	1/22+2/25	F01
F020T671ZA75	90	3	900	900	S24	S24	102	92	1/28+2/29	F01
F020T665ZA75	90	3	900	900	S24	S24	122	78	1/22+2/25	F01
F020T659ZA75	90	3	900	900	S24	S24	160	79	1/22+2/24	F01
F020T647ZA75	90	3	900	900	S24	S24	142	86	1/25+2/26	F01
F020T637ZA75	90	3	900	900	S24	S24	150	77	1/22+2/23	F01
F020T663ZA75	90	3	900	900	S24	S24	130	80	1/24+2/25	F01
F020T709ZA75	90	2	900	900	S24	S24	121	58	2/27	F01.10
F020T711ZA75	90	2	900	900	S24	S24	123	60	2/28	F01.10

achter-arrière-rear-Hinten

F020T776ZA70	100	2/1	780	780	--	--	53	131	2/37+1/49	F08RB
F020T770ZA70	100	4/1	780	780	--	--	132	138	4/23+1/31	F08RB

BESTELNR N° COMMANDE ORDER NR BESTELNR	BR LRG WID BR	BLADEN LAMES LEAVES BLATT.	B	C	D1	D2	PH FL FA SP	PAK EP TH PAK	DETAIL	MOD	OPMERKINGEN REMARQUES REMARKS BEMERKUNGEN
---	------------------------	-------------------------------------	---	---	----	----	----------------------	------------------------	--------	-----	--

SERIE : ACTROS**2643****voor-avant-front-Vorne**

F020T669ZA75	90	2	900	900	S24	S24	116	62	2/28	F01
F020T647ZA75	90	3	900	900	S24	S24	142	86	1/25+2/26	F01
F020T665ZA75	90	3	900	900	S24	S24	122	78	1/22+2/25	F01
F020T663ZA75	90	3	900	900	S24	S24	130	80	1/24+2/25	F01
F020T671ZA75	90	3	900	900	S24	S24	102	92	1/28+2/29	F01
F020T637ZA75	90	3	900	900	S24	S24	150	77	1/22+2/23	F01
F020T659ZA75	90	3	900	900	S24	S24	160	79	1/22+2/24	F01
F020T649ZA75	90	3	900	900	S24	S24	140	81	1/22+2/25	F01
F020T709ZA75	90	2	900	900	S24	S24	121	58	2/27	F01.10
F020T711ZA75	90	2	900	900	S24	S24	123	60	2/28	F01.10

achter-arrière-rear-Hinten

F020T776ZA70	100	2/1	780	780	--	--	53	131	2/37+1/49	F08RB
F020T770ZA70	100	4/1	780	780	--	--	132	138	4/23+1/31	F08RB

2648**voor-avant-front-Vorne**

F020T669ZA75	90	2	900	900	S24	S24	116	62	2/28	F01
F020T647ZA75	90	3	900	900	S24	S24	142	86	1/25+2/26	F01
F020T671ZA75	90	3	900	900	S24	S24	102	92	1/28+2/29	F01
F020T665ZA75	90	3	900	900	S24	S24	122	78	1/22+2/25	F01
F020T663ZA75	90	3	900	900	S24	S24	130	80	1/24+2/25	F01
F020T649ZA75	90	3	900	900	S24	S24	140	81	1/22+2/25	F01
F020T637ZA75	90	3	900	900	S24	S24	150	77	1/22+2/23	F01
F020T659ZA75	90	3	900	900	S24	S24	160	79	1/22+2/24	F01
F020T709ZA75	90	2	900	900	S24	S24	121	58	2/27	F01.10
F020T711ZA75	90	2	900	900	S24	S24	123	60	2/28	F01.10

achter-arrière-rear-Hinten

F020T776ZA70	100	2/1	780	780	--	--	53	131	2/37+1/49	F08RB
F020T770ZA70	100	4/1	780	780	--	--	132	138	4/23+1/31	F08RB

BESTELNR N° COMMANDE ORDER NR BESTELNR	BR LRG WID BR	BLADEN LAMES LEAVES BLATT.	B	C	D1	D2	PH FL FA SP	PAK EP TH PAK	DETAIL	MOD	OPMERKINGEN REMARQUES REMARKS BEMERKUNGEN
---	------------------------	-------------------------------------	---	---	----	----	----------------------	------------------------	--------	-----	--

SERIE : ACTROS**2653****voor-avant-front-Vorne**

F020T669ZA75	90	2	900	900	S24	S24	116	62	2/28	F01
F020T649ZA75	90	3	900	900	S24	S24	140	81	1/22+2/25	F01
F020T671ZA75	90	3	900	900	S24	S24	102	92	1/28+2/29	F01
F020T659ZA75	90	3	900	900	S24	S24	160	79	1/22+2/24	F01
F020T637ZA75	90	3	900	900	S24	S24	150	77	1/22+2/23	F01
F020T663ZA75	90	3	900	900	S24	S24	130	80	1/24+2/25	F01
F020T647ZA75	90	3	900	900	S24	S24	142	86	1/25+2/26	F01
F020T709ZA75	90	2	900	900	S24	S24	121	58	2/27	F01.10
F020T711ZA75	90	2	900	900	S24	S24	123	60	2/28	F01.10

achter-arrière-rear-Hinten

F020T776ZA70	100	2/1	780	780	--	--	53	131	2/37+1/49	F08RB
F020T770ZA70	100	4/1	780	780	--	--	132	138	4/23+1/31	F08RB

2657**voor-avant-front-Vorne**

F020T669ZA75	90	2	900	900	S24	S24	116	62	2/28	F01
F020T671ZA75	90	3	900	900	S24	S24	102	92	1/28+2/29	F01
F020T637ZA75	90	3	900	900	S24	S24	150	77	1/22+2/23	F01
F020T647ZA75	90	3	900	900	S24	S24	142	86	1/25+2/26	F01
F020T649ZA75	90	3	900	900	S24	S24	140	81	1/22+2/25	F01
F020T659ZA75	90	3	900	900	S24	S24	160	79	1/22+2/24	F01
F020T663ZA75	90	3	900	900	S24	S24	130	80	1/24+2/25	F01
F020T709ZA75	90	2	900	900	S24	S24	121	58	2/27	F01.10
F020T711ZA75	90	2	900	900	S24	S24	123	60	2/28	F01.10

BESTELNR N° COMMANDE ORDER NR BESTELNR	BR LRG WID BR	BLADEN LAMES LEAVES BLATT.	B	C	D1	D2	PH FL FA SP	PAK EP TH PAK	DETAIL	MOD	OPMERKINGEN REMARQUES REMARKS BEMERKUNGEN
---	------------------------	-------------------------------------	---	---	----	----	----------------------	------------------------	--------	-----	--

SERIE : ACTROS

3231

voor-avant-front-Vorne

F020T675ZA75	90	3	780	800	S24	S24	80	82	1/23+2/25	F01
F020T673ZA75	90	3	900	680	S24	S24	84	82	1/23+2/25	F01

achter-arrière-rear-Hinten

F020T776ZA70	100	2/1	780	780	--	--	53	131	2/37+1/49	F08RB
--------------	-----	-----	-----	-----	----	----	----	-----	-----------	-------

3235

voor-avant-front-Vorne

F020T675ZA75	90	3	780	800	S24	S24	80	82	1/23+2/25	F01
F020T673ZA75	90	3	900	680	S24	S24	84	82	1/23+2/25	F01

achter-arrière-rear-Hinten

F020T776ZA70	100	2/1	780	780	--	--	53	131	2/37+1/49	F08RB
--------------	-----	-----	-----	-----	----	----	----	-----	-----------	-------

3240

voor-avant-front-Vorne

F020T675ZA75	90	3	780	800	S24	S24	80	82	1/23+2/25	F01
F020T673ZA75	90	3	900	680	S24	S24	84	82	1/23+2/25	F01

achter-arrière-rear-Hinten

F020T776ZA70	100	2/1	780	780	--	--	53	131	2/37+1/49	F08RB
F020T770ZA70	100	4/1	780	780	--	--	132	138	4/23+1/31	F08RB

BESTELNR N° COMMANDE ORDER NR BESTELNR	BR LRG WID BR	BLADEN LAMES LEAVES BLATT.	B	C	D1	D2	PH FL FA SP	PAK EP TH PAK	DETAIL	MOD	OPMERKINGEN REMARQUES REMARKS BEMERKUNGEN
---	------------------------	-------------------------------------	---	---	----	----	----------------------	------------------------	--------	-----	--

SERIE : ACTROS

3243

voor-avant-front-Vorne

F020T675ZA75	90	3	780	800	S24	S24	80	82	1/23+2/25	F01
F020T673ZA75	90	3	900	680	S24	S24	84	82	1/23+2/25	F01

achter-arrière-rear-Hinten

F020T776ZA70	100	2/1	780	780	--	--	53	131	2/37+1/49	F08RB
F020T770ZA70	100	4/1	780	780	--	--	132	138	4/23+1/31	F08RB

3331

voor-avant-front-Vorne

F020T671ZA75	90	3	900	900	S24	S24	102	92	1/28+2/29	F01
F020T663ZA75	90	3	900	900	S24	S24	130	80	1/24+2/25	F01
F020T659ZA75	90	3	900	900	S24	S24	160	79	1/22+2/24	F01
F020T647ZA75	90	3	900	900	S24	S24	142	86	1/25+2/26	F01
F020T649ZA75	90	3	900	900	S24	S24	140	81	1/22+2/25	F01
F020T713ZA75	90	3	970	830	S24	S24		81	1/23+2/25	F01
F020T731ZA75	90	3	970	830	S24	S24	94	90	3/28	F01
F020T711ZA75	90	2	900	900	S24	S24	123	60	2/28	F01.10

achter-arrière-rear-Hinten

F020T774ZA70	100	4	780	780	--	--	55	160	4/37	F08R
F020T772ZA70	100	4	780	780	--	--	80	144	4/33	F08R
F020T796ZA70	100	5	780	780	--	--	56	200	5/37	F08R
F020T792ZA70	100	3	830	830	--	--	82	129	3/40	F08R
F020T794ZA70	100	4	835	835	--	--	82	172	4/40	F08R

3331 A

achter-arrière-rear-Hinten

F020T794ZA70	100	4	835	835	--	--	82	172	4/40	F08R
--------------	-----	---	-----	-----	----	----	----	-----	------	------

BESTELNR N° COMMANDE ORDER NR BESTELLNR	BR LRG WID BR	BLADEN LAMES LEAVES BLATT.	B	C	D1	D2	PH FL FA SP	PAK EP TH PAK	DETAIL	MOD	OPMERKINGEN REMARQUES REMARKS BEMERKUNGEN
--	------------------------	-------------------------------------	---	---	----	----	----------------------	------------------------	--------	-----	--

SERIE : ACTROS**3331 AK****achter-arrière-rear-Hinten**

F020T794ZA70	100	4	835	835	--	--	82	172	4/40	F08R
--------------	-----	---	-----	-----	----	----	----	-----	------	------

3331 AS**achter-arrière-rear-Hinten**

F020T794ZA70	100	4	835	835	--	--	82	172	4/40	F08R
--------------	-----	---	-----	-----	----	----	----	-----	------	------

3331 B**achter-arrière-rear-Hinten**

F020T794ZA70	100	4	835	835	--	--	82	172	4/40	F08R
--------------	-----	---	-----	-----	----	----	----	-----	------	------

3331 K**achter-arrière-rear-Hinten**

F020T794ZA70	100	4	835	835	--	--	82	172	4/40	F08R
--------------	-----	---	-----	-----	----	----	----	-----	------	------

3331 S**achter-arrière-rear-Hinten**

F020T794ZA70	100	4	835	835	--	--	82	172	4/40	F08R
--------------	-----	---	-----	-----	----	----	----	-----	------	------

3334 A**achter-arrière-rear-Hinten**

F020T794ZA70	100	4	835	835	--	--	82	172	4/40	F08R
--------------	-----	---	-----	-----	----	----	----	-----	------	------

BESTELNR N° COMMANDE ORDER NR BESTELNR	BR LRG WID BR	BLADEN LAMES LEAVES BLATT.	B	C	D1	D2	PH FL FA SP	PAK EP TH PAK	DETAIL	MOD	OPMERKINGEN REMARQUES REMARKS BEMERKUNGEN
---	------------------------	-------------------------------------	---	---	----	----	----------------------	------------------------	--------	-----	--

SERIE : ACTROS**3335****voor-avant-front-Vorne**

F020T647ZA75	90	3	900	900	S24	S24	142	86	1/25+2/26	F01
F020T671ZA75	90	3	900	900	S24	S24	102	92	1/28+2/29	F01
F020T663ZA75	90	3	900	900	S24	S24	130	80	1/24+2/25	F01
F020T659ZA75	90	3	900	900	S24	S24	160	79	1/22+2/24	F01
F020T649ZA75	90	3	900	900	S24	S24	140	81	1/22+2/25	F01
F020T713ZA75	90	3	970	830	S24	S24		81	1/23+2/25	F01
F020T731ZA75	90	3	970	830	S24	S24	94	90	3/28	F01
F020T711ZA75	90	2	900	900	S24	S24	123	60	2/28	F01.10

achter-arrière-rear-Hinten

F020T774ZA70	100	4	780	780	--	--	55	160	4/37	F08R
F020T772ZA70	100	4	780	780	--	--	80	144	4/33	F08R
F020T796ZA70	100	5	780	780	--	--	56	200	5/37	F08R
F020T792ZA70	100	3	830	830	--	--	82	129	3/40	F08R

3340**voor-avant-front-Vorne**

F020T647ZA75	90	3	900	900	S24	S24	142	86	1/25+2/26	F01
F020T671ZA75	90	3	900	900	S24	S24	102	92	1/28+2/29	F01
F020T663ZA75	90	3	900	900	S24	S24	130	80	1/24+2/25	F01
F020T649ZA75	90	3	900	900	S24	S24	140	81	1/22+2/25	F01
F020T659ZA75	90	3	900	900	S24	S24	160	79	1/22+2/24	F01
F020T713ZA75	90	3	970	830	S24	S24		81	1/23+2/25	F01
F020T731ZA75	90	3	970	830	S24	S24	94	90	3/28	F01
F020T711ZA75	90	2	900	900	S24	S24	123	60	2/28	F01.10

achter-arrière-rear-Hinten

F020T774ZA70	100	4	780	780	--	--	55	160	4/37	F08R
F020T772ZA70	100	4	780	780	--	--	80	144	4/33	F08R
F020T796ZA70	100	5	780	780	--	--	56	200	5/37	F08R
F020T792ZA70	100	3	830	830	--	--	82	129	3/40	F08R

BESTELNR N° COMMANDE ORDER NR BESTELNR	BR LRG WID BR	BLADEN LAMES LEAVES BLATT.	B	C	D1	D2	PH FL FA SP	PAK EP TH PAK	DETAIL	MOD	OPMERKINGEN REMARQUES REMARKS BEMERKUNGEN
---	------------------------	-------------------------------------	---	---	----	----	----------------------	------------------------	--------	-----	--

SERIE : ACTROS

3340 B

achter-arrière-rear-Hinten

F020T794ZA70	100	4	835	835	--	--	82	172	4/40	F08R
--------------	-----	---	-----	-----	----	----	----	-----	------	------

3340 K

achter-arrière-rear-Hinten

F020T794ZA70	100	4	835	835	--	--	82	172	4/40	F08R
--------------	-----	---	-----	-----	----	----	----	-----	------	------

3343

voor-avant-front-Vorne

F020T659ZA75	90	3	900	900	S24	S24	160	79	1/22+2/24	F01
F020T663ZA75	90	3	900	900	S24	S24	130	80	1/24+2/25	F01
F020T647ZA75	90	3	900	900	S24	S24	142	86	1/25+2/26	F01
F020T649ZA75	90	3	900	900	S24	S24	140	81	1/22+2/25	F01
F020T671ZA75	90	3	900	900	S24	S24	102	92	1/28+2/29	F01
F020T713ZA75	90	3	970	830	S24	S24		81	1/23+2/25	F01
F020T731ZA75	90	3	970	830	S24	S24	94	90	3/28	F01
F020T711ZA75	90	2	900	900	S24	S24	123	60	2/28	F01.10

achter-arrière-rear-Hinten

F020T774ZA70	100	4	780	780	--	--	55	160	4/37	F08R
F020T772ZA70	100	4	780	780	--	--	80	144	4/33	F08R
F020T796ZA70	100	5	780	780	--	--	56	200	5/37	F08R
F020T792ZA70	100	3	830	830	--	--	82	129	3/40	F08R

3343 AK

achter-arrière-rear-Hinten

F020T794ZA70	100	4	835	835	--	--	82	172	4/40	F08R
--------------	-----	---	-----	-----	----	----	----	-----	------	------

BESTELNR N° COMMANDE ORDER NR BESTELNR	BR LRG WID BR	BLADEN LAMES LEAVES BLATT.	B	C	D1	D2	PH FL FA SP	PAK EP TH PAK	DETAIL	MOD	OPMERKINGEN REMARKS BEMERKUNGEN
---	------------------------	-------------------------------------	---	---	----	----	----------------------	------------------------	--------	-----	---------------------------------------

SERIE : ACTROS**3348****voor-avant-front-Vorne**

F020T647ZA75	90	3	900	900	S24	S24	142	86	1/25+2/26	F01
F020T671ZA75	90	3	900	900	S24	S24	102	92	1/28+2/29	F01
F020T663ZA75	90	3	900	900	S24	S24	130	80	1/24+2/25	F01
F020T659ZA75	90	3	900	900	S24	S24	160	79	1/22+2/24	F01
F020T649ZA75	90	3	900	900	S24	S24	140	81	1/22+2/25	F01
F020T713ZA75	90	3	970	830	S24	S24		81	1/23+2/25	F01
F020T731ZA75	90	3	970	830	S24	S24	94	90	3/28	F01
F020T711ZA75	90	2	900	900	S24	S24	123	60	2/28	F01.10

achter-arrière-rear-Hinten

F020T774ZA70	100	4	780	780	--	--	55	160	4/37	F08R
F020T772ZA70	100	4	780	780	--	--	80	144	4/33	F08R
F020T796ZA70	100	5	780	780	--	--	56	200	5/37	F08R
F020T792ZA70	100	3	830	830	--	--	82	129	3/40	F08R

3348 AK**achter-arrière-rear-Hinten**

F020T794ZA70	100	4	835	835	--	--	82	172	4/40	F08R
--------------	-----	---	-----	-----	----	----	----	-----	------	------

3348 K**achter-arrière-rear-Hinten**

F020T794ZA70	100	4	835	835	--	--	82	172	4/40	F08R
--------------	-----	---	-----	-----	----	----	----	-----	------	------

BESTELNR N° COMMANDE ORDER NR BESTELNR	BR LRG WID BR	BLADEN LAMES LEAVES BLATT.	B	C	D1	D2	PH FL FA SP	PAK EP TH PAK	DETAIL	MOD	OPMERKINGEN REMARQUES REMARKS BEMERKUNGEN
---	------------------------	-------------------------------------	---	---	----	----	----------------------	------------------------	--------	-----	--

SERIE : ACTROS

3353

voor-avant-front-Vorne

F020T649ZA75	90	3	900	900	S24	S24	140	81	1/22+2/25	F01
F020T647ZA75	90	3	900	900	S24	S24	142	86	1/25+2/26	F01
F020T671ZA75	90	3	900	900	S24	S24	102	92	1/28+2/29	F01
F020T659ZA75	90	3	900	900	S24	S24	160	79	1/22+2/24	F01
F020T713ZA75	90	3	970	830	S24	S24		81	1/23+2/25	F01
F020T731ZA75	90	3	970	830	S24	S24	94	90	3/28	F01
F020T711ZA75	90	2	900	900	S24	S24	123	60	2/28	F01.10

achter-arrière-rear-Hinten

F020T774ZA70	100	4	780	780	--	--	55	160	4/37	F08R
F020T772ZA70	100	4	780	780	--	--	80	144	4/33	F08R
F020T792ZA70	100	3	830	830	--	--	82	129	3/40	F08R
F020T794ZA70	100	4	835	835	--	--	82	172	4/40	F08R

3353 AS

achter-arrière-rear-Hinten

F020T794ZA70	100	4	835	835	--	--	82	172	4/40	F08R
--------------	-----	---	-----	-----	----	----	----	-----	------	------

3357

achter-arrière-rear-Hinten

F020T794ZA70	100	4	835	835	--	--	82	172	4/40	F08R
--------------	-----	---	-----	-----	----	----	----	-----	------	------

3357 S

achter-arrière-rear-Hinten

F020T794ZA70	100	4	835	835	--	--	82	172	4/40	F08R
--------------	-----	---	-----	-----	----	----	----	-----	------	------

BESTELNR N° COMMANDE ORDER NR BESTELNR	BR LRG WID BR	BLADEN LAMES LEAVES BLATT.	B	C	D1	D2	PH FL FA SP	PAK EP TH PAK	DETAIL	MOD	OPMERKINGEN REMARQUES REMARKS BEMERKUNGEN
---	------------------------	-------------------------------------	---	---	----	----	----------------------	------------------------	--------	-----	--

SERIE : ACTROS**4140****voor-avant-front-Vorne**

F020T675ZA75	90	3	780	800	S24	S24	80	82	1/23+2/25	F01
F020T693ZA75	90	4	780	800	S24	S24	87	104	4/23	F01
F020T673ZA75	90	3	900	680	S24	S24	84	82	1/23+2/25	F01
F020T691ZA75	90	4	900	680	S24	S24	100	104	4/23	F01
F020T711ZA75	90	2	900	900	S24	S24	123	60	2/28	F01.10

achter-arrière-rear-Hinten

F020T774ZA70	100	4	780	780	--	--	55	160	4/37	F08R
F020T796ZA70	100	5	780	780	--	--	56	200	5/37	F08R
F020T792ZA70	100	3	830	830	--	--	82	129	3/40	F08R

4140 AK**achter-arrière-rear-Hinten**

F020T774ZA70	100	4	780	780	--	--	55	160	4/37	F08R
F020T796ZA70	100	5	780	780	--	--	56	200	5/37	F08R
F020T792ZA70	100	3	830	830	--	--	82	129	3/40	F08R
F020T794ZA70	100	4	835	835	--	--	82	172	4/40	F08R
F020T906ZA70	100	3/2	835	835	--	--	60	231	3/40+2/48	F08R

4140 B**achter-arrière-rear-Hinten**

F020T794ZA70	100	4	835	835	--	--	82	172	4/40	F08R
--------------	-----	---	-----	-----	----	----	----	-----	------	------

BESTELNR N° COMMANDE ORDER NR BESTELNR	BR LRG WID BR	BLADEN LAMES LEAVES BLATT.	B	C	D1	D2	PH FL FA SP	PAK EP TH PAK	DETAIL	MOD	OPMERKINGEN REMARKS REMARKS BEMERKUNGEN
---	------------------------	-------------------------------------	---	---	----	----	----------------------	------------------------	--------	-----	--

SERIE : ACTROS**4143****voor-avant-front-Vorne**

F020T675ZA75	90	3	780	800	S24	S24	80	82	1/23+2/25	F01
F020T693ZA75	90	4	780	800	S24	S24	87	104	4/23	F01
F020T673ZA75	90	3	900	680	S24	S24	84	82	1/23+2/25	F01
F020T691ZA75	90	4	900	680	S24	S24	100	104	4/23	F01

achter-arrière-rear-Hinten

F020T774ZA70	100	4	780	780	--	--	55	160	4/37	F08R
F020T796ZA70	100	5	780	780	--	--	56	200	5/37	F08R
F020T792ZA70	100	3	830	830	--	--	82	129	3/40	F08R

4148**voor-avant-front-Vorne**

F020T675ZA75	90	3	780	800	S24	S24	80	82	1/23+2/25	F01
F020T693ZA75	90	4	780	800	S24	S24	87	104	4/23	F01
F020T673ZA75	90	3	900	680	S24	S24	84	82	1/23+2/25	F01
F020T691ZA75	90	4	900	680	S24	S24	100	104	4/23	F01

achter-arrière-rear-Hinten

F020T774ZA70	100	4	780	780	--	--	55	160	4/37	F08R
F020T796ZA70	100	5	780	780	--	--	56	200	5/37	F08R
F020T792ZA70	100	3	830	830	--	--	82	129	3/40	F08R

4148 AK**achter-arrière-rear-Hinten**

F020T774ZA70	100	4	780	780	--	--	55	160	4/37	F08R
F020T796ZA70	100	5	780	780	--	--	56	200	5/37	F08R
F020T792ZA70	100	3	830	830	--	--	82	129	3/40	F08R
F020T794ZA70	100	4	835	835	--	--	82	172	4/40	F08R
F020T906ZA70	100	3/2	835	835	--	--	60	231	3/40+2/48	F08R

BESTELNR N° COMMANDE ORDER NR BESTELNR	BR LRG WID BR	BLADEN LAMES LEAVES BLATT.	B	C	D1	D2	PH FL FA SP	PAK EP TH PAK	DETAIL	MOD	OPMERKINGEN REMARQUES REMARKS BEMERKUNGEN
---	------------------------	-------------------------------------	---	---	----	----	----------------------	------------------------	--------	-----	--

SERIE : ATEGO**712****voor-avant-front-Vorne**

F020T703ZA75	80	1	860	940	S16	S16	167	31	1/28	F01.70
F020T705ZA75	80	1	860	940	S16	S16	148	32	1/29	F01.70
F020T707ZA75	80	1	860	940	S16	S16	144	33	1/30	F01.70

achter-arrière-rear-Hinten

F020T810ZA75	80	1/1	800	800	S18	S18	94	62	1/25+1/31	F01B
F020T812ZA75	80	1/1	800	800	S18	S18	112	65	1/25+1/34	F01B
F020T814ZA75	80	1/1	800	800	S18	S18	115	67	1/25+1/36	F01B

714**voor-avant-front-Vorne**

F020T707ZA75	80	1	860	940	S16	S16	144	33	1/30	F01.70
F020T705ZA75	80	1	860	940	S16	S16	148	32	1/29	F01.70

achter-arrière-rear-Hinten

F020T812ZA75	80	1/1	800	800	S18	S18	112	65	1/25+1/34	F01B
F020T814ZA75	80	1/1	800	800	S18	S18	115	67	1/25+1/36	F01B
F020T888ZA75	80	1	780	100	S18		1	45	1/45	F54

715**voor-avant-front-Vorne**

F020T705ZA75	80	1	860	940	S16	S16	148	32	1/29	F01.70
F020T703ZA75	80	1	860	940	S16	S16	167	31	1/28	F01.70

achter-arrière-rear-Hinten

F020T810ZA75	80	1/1	800	800	S18	S18	94	62	1/25+1/31	F01B
F020T812ZA75	80	1/1	800	800	S18	S18	112	65	1/25+1/34	F01B
F020T888ZA75	80	1	780	100	S18		1	45	1/45	F54

BESTELNR N° COMMANDE ORDER NR BESTELNR	BR LRG WID BR	BLADEN LAMES LEAVES BLATT.	B	C	D1	D2	PH FL FA SP	PAK EP TH PAK	DETAIL	MOD	OPMERKINGEN REMARQUES REMARKS BEMERKUNGEN
---	------------------------	-------------------------------------	---	---	----	----	----------------------	------------------------	--------	-----	--

SERIE : ATEGO**717****voor-avant-front-Vorne**

F020T705ZA75	80	1	860	940	S16	S16	148	32	1/29	F01.70
F020T707ZA75	80	1	860	940	S16	S16	144	33	1/30	F01.70

achter-arrière-rear-Hinten

F020T812ZA75	80	1/1	800	800	S18	S18	112	65	1/25+1/34	F01B
F020T814ZA75	80	1/1	800	800	S18	S18	115	67	1/25+1/36	F01B
F020T888ZA75	80	1	780	100	S18		1	45	1/45	F54

812**voor-avant-front-Vorne**

F020T705ZA75	80	1	860	940	S16	S16	148	32	1/29	F01.70
F020T707ZA75	80	1	860	940	S16	S16	144	33	1/30	F01.70

achter-arrière-rear-Hinten

F020T812ZA75	80	1/1	800	800	S18	S18	112	65	1/25+1/34	F01B
F020T814ZA75	80	1/1	800	800	S18	S18	115	67	1/25+1/36	F01B

814**voor-avant-front-Vorne**

F020T707ZA75	80	1	860	940	S16	S16	144	33	1/30	F01.70
--------------	----	---	-----	-----	-----	-----	-----	----	------	--------

achter-arrière-rear-Hinten

F020T814ZA75	80	1/1	800	800	S18	S18	115	67	1/25+1/36	F01B
F020T816ZA75	80	1/1	800	800	S18	S18	97	67	1/25+1/36	F01B
F020T888ZA75	80	1	780	100	S18		1	45	1/45	F54

BESTELNR N° COMMANDE ORDER NR BESTELNR	BR LRG WID BR	BLADEN LAMES LEAVES BLATT.	B	C	D1	D2	PH FL FA SP	PAK EP TH PAK	DETAIL	MOD	OPMERKINGEN REMARKS REMARKS BEMERKUNGEN
---	------------------------	-------------------------------------	---	---	----	----	----------------------	------------------------	--------	-----	--

SERIE : ATEGO**815****voor-avant-front-Vorne**

F020T705ZA75	80	1	860	940	S16	S16	148	32	1/29	F01.70
F020T707ZA75	80	1	860	940	S16	S16	144	33	1/30	F01.70

achter-arrière-rear-Hinten

F020T812ZA75	80	1/1	800	800	S18	S18	112	65	1/25+1/34	F01B
F020T814ZA75	80	1/1	800	800	S18	S18	115	67	1/25+1/36	F01B
F020T816ZA75	80	1/1	800	800	S18	S18	97	67	1/25+1/36	F01B
F020T888ZA75	80	1	780	100	S18		1	45	1/45	F54

817**voor-avant-front-Vorne**

F020T707ZA75	80	1	860	940	S16	S16	144	33	1/30	F01.70
F020T705ZA75	80	1	860	940	S16	S16	148	32	1/29	F01.70

achter-arrière-rear-Hinten

F020T812ZA75	80	1/1	800	800	S18	S18	112	65	1/25+1/34	F01B
F020T814ZA75	80	1/1	800	800	S18	S18	115	67	1/25+1/36	F01B
F020T816ZA75	80	1/1	800	800	S18	S18	97	67	1/25+1/36	F01B
F020T888ZA75	80	1	780	100	S18		1	45	1/45	F54

823**voor-avant-front-Vorne**

F020T707ZA75	80	1	860	940	S16	S16	144	33	1/30	F01.70
--------------	----	---	-----	-----	-----	-----	-----	----	------	--------

achter-arrière-rear-Hinten

F020T814ZA75	80	1/1	800	800	S18	S18	115	67	1/25+1/36	F01B
F020T816ZA75	80	1/1	800	800	S18	S18	97	67	1/25+1/36	F01B
F020T888ZA75	80	1	780	100	S18		1	45	1/45	F54

BESTELNR N° COMMANDE ORDER NR BESTELNR	BR LRG WID BR	BLADEN LAMES LEAVES BLATT.	B	C	D1	D2	PH FL FA SP	PAK EP TH PAK	DETAIL	MOD	OPMERKINGEN REMARQUES REMARKS BEMERKUNGEN
---	------------------------	-------------------------------------	---	---	----	----	----------------------	------------------------	--------	-----	--

SERIE : ATEGO**915****voor-avant-front-Vorne**

F020T715ZA75	80	2	860	940	S18	S18	175	54	1/24+1/26	F01.70
F020T717ZA75	80	2	860	940	S18	S18	175	56	1/25+1/27	F01.70
F020T701ZA75	80	2	860	940	S18	S18	150	61	1/27+1/28	F01.70

achter-arrière-rear-Hinten

A	A020T904ZA76	80	9/P/8	850	850	S22	S22	144	239	9/14+P/9+8/13	A01A.70
	A020T904ZA75	80	9	850	850	S22	S22	144	126	9/14	A01.70
H	A020T904HA80	80	8/P	710	700	--	--		113	8/13+P/9	A08
	F020T816ZA75	80	1/1	800	800	S18	S18	97	67	1/25+1/36	F01B

917**voor-avant-front-Vorne**

F020T715ZA75	80	2	860	940	S18	S18	175	54	1/24+1/26	F01.70
--------------	----	---	-----	-----	-----	-----	-----	----	-----------	--------

achter-arrière-rear-Hinten

A	A020T904ZA76	80	9/P/8	850	850	S22	S22	144	239	9/14+P/9+8/13	A01A.70
	A020T904ZA75	80	9	850	850	S22	S22	144	126	9/14	A01.70
H	A020T904HA80	80	8/P	710	700	--	--		113	8/13+P/9	A08
	F020T826ZA75	80	1/1	850	850	S22	S22	142	73	1/28+1/41	F01B
	F020T824ZA75	80	2/1	850	850	S22	S22	135	94	1/22+1/23+1/43	F01B

923**voor-avant-front-Vorne**

F020T715ZA75	80	2	860	940	S18	S18	175	54	1/24+1/26	F01.70
--------------	----	---	-----	-----	-----	-----	-----	----	-----------	--------

achter-arrière-rear-Hinten

A	A020T904ZA76	80	9/P/8	850	850	S22	S22	144	239	9/14+P/9+8/13	A01A.70
	A020T904ZA75	80	9	850	850	S22	S22	144	126	9/14	A01.70
H	A020T904HA80	80	8/P	710	700	--	--		113	8/13+P/9	A08
	F020T826ZA75	80	1/1	850	850	S22	S22	142	73	1/28+1/41	F01B
	F020T824ZA75	80	2/1	850	850	S22	S22	135	94	1/22+1/23+1/43	F01B

BESTELNR N° COMMANDE ORDER NR BESTELNR	BR LRG WID BR	BLADEN LAMES LEAVES BLATT.	B	C	D1	D2	PH FL FA SP	PAK EP TH PAK	DETAIL	MOD	OPMERKINGEN REMARQUES REMARKS BEMERKUNGEN
---	------------------------	-------------------------------------	---	---	----	----	----------------------	------------------------	--------	-----	--

SERIE : ATEGO**925****voor-avant-front-Vorne**

F020T715ZA75	80	2	860	940	S18	S18	175	54	1/24+1/26	F01.70
F020T717ZA75	80	2	860	940	S18	S18	175	56	1/25+1/27	F01.70
F020T701ZA75	80	2	860	940	S18	S18	150	61	1/27+1/28	F01.70

achter-arrière-rear-Hinten

A	A020T904ZA76	80	9/P/8	850	850	S22	S22	144	239	9/14+P/9+8/13	A01A.70
	A020T904ZA75	80	9	850	850	S22	S22	144	126	9/14	A01.70
H	A020T904HA80	80	8/P	710	700	--	--		113	8/13+P/9	A08
	F020T816ZA75	80	1/1	800	800	S18	S18	97	67	1/25+1/36	F01B

1017**voor-avant-front-Vorne**

F020T715ZA75	80	2	860	940	S18	S18	175	54	1/24+1/26	F01.70
F020T717ZA75	80	2	860	940	S18	S18	175	56	1/25+1/27	F01.70
F020T729ZA75	80	2	860	940	S18	S18	145	60	1/27+1/29	F01.70
F020T737ZA75	80	2	860	940	S18	S18	165	53	1/24+1/25	F01.70

achter-arrière-rear-Hinten

A	A020T904ZA76	80	9/P/8	850	850	S22	S22	144	239	9/14+P/9+8/13	A01A.70
	A020T904ZA75	80	9	850	850	S22	S22	144	126	9/14	A01.70
H	A020T904HA80	80	8/P	710	700	--	--		113	8/13+P/9	A08
	F020T824ZA75	80	2/1	850	850	S22	S22	135	94	1/22+1/23+1/43	F01B
	F020T848ZA75	80	2/1	850	850	S22	S22	127	103	1/23+1/24+1/45	F01B

BESTELNR N° COMMANDE ORDER NR BESTELNR	BR LRG WID BR	BLADEN LAMES LEAVES BLATT.	B	C	D1	D2	PH FL FA SP	PAK EP TH PAK	DETAIL	MOD	OPMERKINGEN REMARQUES REMARKS BEMERKUNGEN
---	------------------------	-------------------------------------	---	---	----	----	----------------------	------------------------	--------	-----	--

SERIE : ATEGO

1214

voor-avant-front-Vorne

F020T701ZA75	80	2	860	940	S18	S18	150	61	1/27+1/28	F01.70
F020T717ZA75	80	2	860	940	S18	S18	175	56	1/25+1/27	F01.70
F020T715ZA75	80	2	860	940	S18	S18	175	54	1/24+1/26	F01.70

achter-arrière-rear-Hinten

A	A020T904ZA76	80	9/P/8	850	850	S22	S22	144	239	9/14+P/9+8/13	A01A.70
	A020T904ZA75	80	9	850	850	S22	S22	144	126	9/14	A01.70
H	A020T904HA80	80	8/P	710	700	--	--		113	8/13+P/9	A08
	F020T846ZA75	80	2/1	850	850	S22	S22	118	103	1/23+1/26+1/47	F01B
	F020T848ZA75	80	2/1	850	850	S22	S22	127	103	1/23+1/24+1/45	F01B

1215

voor-avant-front-Vorne

F020T701ZA75	80	2	860	940	S18	S18	150	61	1/27+1/28	F01.70
F020T715ZA75	80	2	860	940	S18	S18	175	54	1/24+1/26	F01.70
F020T717ZA75	80	2	860	940	S18	S18	175	56	1/25+1/27	F01.70

achter-arrière-rear-Hinten

A	A020T904ZA76	80	9/P/8	850	850	S22	S22	144	239	9/14+P/9+8/13	A01A.70
	A020T904ZA75	80	9	850	850	S22	S22	144	126	9/14	A01.70
H	A020T904HA80	80	8/P	710	700	--	--		113	8/13+P/9	A08
	F020T846ZA75	80	2/1	850	850	S22	S22	118	103	1/23+1/26+1/47	F01B
	F020T848ZA75	80	2/1	850	850	S22	S22	127	103	1/23+1/24+1/45	F01B

BESTELNR N° COMMANDE ORDER NR BESTELNR	BR LRG WID BR	BLADEN LAMES LEAVES BLATT.	B	C	D1	D2	PH FL FA SP	PAK EP TH PAK	DETAIL	MOD	OPMERKINGEN REMARQUES REMARKS BEMERKUNGEN
---	------------------------	-------------------------------------	---	---	----	----	----------------------	------------------------	--------	-----	--

SERIE : ATEGO**1217****voor-avant-front-Vorne**

F020T715ZA75	80	2	860	940	S18	S18	175	54	1/24+1/26	F01.70
F020T701ZA75	80	2	860	940	S18	S18	150	61	1/27+1/28	F01.70
F020T717ZA75	80	2	860	940	S18	S18	175	56	1/25+1/27	F01.70

achter-arrière-rear-Hinten

A	A020T904ZA76	80	9/P/8	850	850	S22	S22	144	239	9/14+P/9+8/13	A01A.70
	A020T904ZA75	80	9	850	850	S22	S22	144	126	9/14	A01.70
H	A020T904HA80	80	8/P	710	700	--	--		113	8/13+P/9	A08
	F020T846ZA75	80	2/1	850	850	S22	S22	118	103	1/23+1/26+1/47	F01B
	F020T848ZA75	80	2/1	850	850	S22	S22	127	103	1/23+1/24+1/45	F01B

1223**voor-avant-front-Vorne**

F020T701ZA75	80	2	860	940	S18	S18	150	61	1/27+1/28	F01.70
F020T715ZA75	80	2	860	940	S18	S18	175	54	1/24+1/26	F01.70
F020T717ZA75	80	2	860	940	S18	S18	175	56	1/25+1/27	F01.70

achter-arrière-rear-Hinten

A	A020T904ZA76	80	9/P/8	850	850	S22	S22	144	239	9/14+P/9+8/13	A01A.70
	A020T904ZA75	80	9	850	850	S22	S22	144	126	9/14	A01.70
H	A020T904HA80	80	8/P	710	700	--	--		113	8/13+P/9	A08
	F020T846ZA75	80	2/1	850	850	S22	S22	118	103	1/23+1/26+1/47	F01B
	F020T848ZA75	80	2/1	850	850	S22	S22	127	103	1/23+1/24+1/45	F01B

BESTELNR N° COMMANDE ORDER NR BESTELNR	BR LRG WID BR	BLADEN LAMES LEAVES BLATT.	B	C	D1	D2	PH FL FA SP	PAK EP TH PAK	DETAIL	MOD	OPMERKINGEN REMARQUES REMARKS BEMERKUNGEN
---	------------------------	-------------------------------------	---	---	----	----	----------------------	------------------------	--------	-----	--

SERIE : ATEGO

1225

voor-avant-front-Vorne

F020T701ZA75	80	2	860	940	S18	S18	150	61	1/27+1/28	F01.70
F020T715ZA75	80	2	860	940	S18	S18	175	54	1/24+1/26	F01.70
F020T717ZA75	80	2	860	940	S18	S18	175	56	1/25+1/27	F01.70

achter-arrière-rear-Hinten

A	A020T904ZA76	80	9/P/8	850	850	S22	S22	144	239	9/14+P/9+8/13	A01A.70
	A020T904ZA75	80	9	850	850	S22	S22	144	126	9/14	A01.70
H	A020T904HA80	80	8/P	710	700	--	--		113	8/13+P/9	A08
	F020T846ZA75	80	2/1	850	850	S22	S22	118	103	1/23+1/26+1/47	F01B
	F020T848ZA75	80	2/1	850	850	S22	S22	127	103	1/23+1/24+1/45	F01B

1228

voor-avant-front-Vorne

F020T701ZA75	80	2	860	940	S18	S18	150	61	1/27+1/28	F01.70
F020T715ZA75	80	2	860	940	S18	S18	175	54	1/24+1/26	F01.70
F020T717ZA75	80	2	860	940	S18	S18	175	56	1/25+1/27	F01.70

achter-arrière-rear-Hinten

A	A020T904ZA76	80	9/P/8	850	850	S22	S22	144	239	9/14+P/9+8/13	A01A.70
	A020T904ZA75	80	9	850	850	S22	S22	144	126	9/14	A01.70
H	A020T904HA80	80	8/P	710	700	--	--		113	8/13+P/9	A08
	F020T848ZA75	80	2/1	850	850	S22	S22	127	103	1/23+1/24+1/45	F01B
	F020T846ZA75	80	2/1	850	850	S22	S22	118	103	1/23+1/26+1/47	F01B

BESTELNR N° COMMANDE ORDER NR BESTELNR	BR LRG WID BR	BLADEN LAMES LEAVES BLATT.	B	C	D1	D2	PH FL FA SP	PAK EP TH PAK	DETAIL	MOD	OPMERKINGEN REMARKS REMARKS BEMERKUNGEN
---	------------------------	-------------------------------------	---	---	----	----	----------------------	------------------------	--------	-----	--

SERIE : ATEGO**1317****voor-avant-front-Vorne**

F020T717ZA75	80	2	860	940	S18	S18	175	56	1/25+1/27	F01.70
F020T729ZA75	80	2	860	940	S18	S18	145	60	1/27+1/29	F01.70
F020T723ZA75	80	2	860	940	S18	S18	115	65	1/30+1/31	F01.70
F020T701ZA75	80	2	860	940	S18	S18	150	61	1/27+1/28	F01.70

achter-arrière-rear-Hinten

A	A020T890ZA76	80	11/P/11	850	850	S22	S22		295		A01A.70
	A020T890ZA75	80	11	850	850	S22	S22		143	11/13	A01.70
H	A020T890HA80	80	11/P	710	700	--	--		152	11/13+P/9	A08
	F020T880ZA75	80	6	850	630	S22	S22	11	162	6/25	F01
	F020T846ZA75	80	2/1	850	850	S22	S22	118	103	1/23+1/26+1/47	F01B
	F020T850ZA75	80	2/2	850	850	S22	S22	90	137	1/23+1/28+2/39	F01B

1323**voor-avant-front-Vorne**

F020T729ZA75	80	2	860	940	S18	S18	145	60	1/27+1/29	F01.70
F020T701ZA75	80	2	860	940	S18	S18	150	61	1/27+1/28	F01.70
F020T717ZA75	80	2	860	940	S18	S18	175	56	1/25+1/27	F01.70

achter-arrière-rear-Hinten

A	A020T890ZA76	80	11/P/11	850	850	S22	S22		295		A01A.70
	A020T890ZA75	80	11	850	850	S22	S22		143	11/13	A01.70
H	A020T890HA80	80	11/P	710	700	--	--		152	11/13+P/9	A08
	F020T880ZA75	80	6	850	630	S22	S22	11	162	6/25	F01
	F020T846ZA75	80	2/1	850	850	S22	S22	118	103	1/23+1/26+1/47	F01B
	F020T850ZA75	80	2/2	850	850	S22	S22	90	137	1/23+1/28+2/39	F01B

BESTELNR N° COMMANDE ORDER NR BESTELNR	BR LRG WID BR	BLADEN LAMES LEAVES BLATT.	B	C	D1	D2	PH FL FA SP	PAK EP TH PAK	DETAIL	MOD	OPMERKINGEN REMARKS BEMERKUNGEN
---	------------------------	-------------------------------------	---	---	----	----	----------------------	------------------------	--------	-----	---------------------------------------

SERIE : ATEGO**1325****voor-avant-front-Vorne**

F020T729ZA75	80	2	860	940	S18	S18	145	60	1/27+1/29	F01.70
F020T723ZA75	80	2	860	940	S18	S18	115	65	1/30+1/31	F01.70
F020T717ZA75	80	2	860	940	S18	S18	175	56	1/25+1/27	F01.70
F020T701ZA75	80	2	860	940	S18	S18	150	61	1/27+1/28	F01.70

achter-arrière-rear-Hinten

A	A020T890ZA76	80	11/P/11	850	850	S22	S22		295		A01A.70
	A020T890ZA75	80	11	850	850	S22	S22		143	11/13	A01.70
H	A020T890HA80	80	11/P	710	700	--	--		152	11/13+P/9	A08
	F020T846ZA75	80	2/1	850	850	S22	S22	118	103	1/23+1/26+1/47	F01B
	F020T850ZA75	80	2/2	850	850	S22	S22	90	137	1/23+1/28+2/39	F01B

1328**voor-avant-front-Vorne**

F020T717ZA75	80	2	860	940	S18	S18	175	56	1/25+1/27	F01.70
F020T701ZA75	80	2	860	940	S18	S18	150	61	1/27+1/28	F01.70
F020T723ZA75	80	2	860	940	S18	S18	115	65	1/30+1/31	F01.70
F020T729ZA75	80	2	860	940	S18	S18	145	60	1/27+1/29	F01.70

achter-arrière-rear-Hinten

A	A020T890ZA76	80	11/P/11	850	850	S22	S22		295		A01A.70
	A020T890ZA75	80	11	850	850	S22	S22		143	11/13	A01.70
H	A020T890HA80	80	11/P	710	700	--	--		152	11/13+P/9	A08
	F020T880ZA75	80	6	850	630	S22	S22	11	162	6/25	F01
	F020T846ZA75	80	2/1	850	850	S22	S22	118	103	1/23+1/26+1/47	F01B
	F020T850ZA75	80	2/2	850	850	S22	S22	90	137	1/23+1/28+2/39	F01B

BESTELNR N° COMMANDE ORDER NR BESTELNR	BR LRG WID BR	BLADEN LAMES LEAVES BLATT.	B	C	D1	D2	PH FL FA SP	PAK EP TH PAK	DETAIL	MOD	OPMERKINGEN REMARKS REMARKS BEMERKUNGEN
---	------------------------	-------------------------------------	---	---	----	----	----------------------	------------------------	--------	-----	--

SERIE : ATEGO**1517****voor-avant-front-Vorne**

F020T701ZA75	80	2	860	940	S18	S18	150	61	1/27+1/28	F01.70
F020T729ZA75	80	2	860	940	S18	S18	145	60	1/27+1/29	F01.70

achter-arrière-rear-Hinten

A	A020T890ZA76	80	11/P/11	850	850	S22	S22		295		A01A.70
	A020T890ZA75	80	11	850	850	S22	S22		143	11/13	A01.70
H	A020T890HA80	80	11/P	710	700	--	--		152	11/13+P/9	A08
	F020T880ZA75	80	6	850	630	S22	S22	11	162	6/25	F01
	F020T850ZA75	80	2/2	850	850	S22	S22	90	137	1/23+1/28+2/39	F01B
	F020T900ZA75	80	2/2	850	850	S22	S22	105	138	1/23+1/28+2/40	F01B

1523**voor-avant-front-Vorne**

F020T701ZA75	80	2	860	940	S18	S18	150	61	1/27+1/28	F01.70
F020T729ZA75	80	2	860	940	S18	S18	145	60	1/27+1/29	F01.70
F020T723ZA75	80	2	860	940	S18	S18	115	65	1/30+1/31	F01.70

achter-arrière-rear-Hinten

A	A020T890ZA76	80	11/P/11	850	850	S22	S22		295		A01A.70
	A020T890ZA75	80	11	850	850	S22	S22		143	11/13	A01.70
H	A020T890HA80	80	11/P	710	700	--	--		152	11/13+P/9	A08
	F020T880ZA75	80	6	850	630	S22	S22	11	162	6/25	F01
	F020T900ZA75	80	2/2	850	850	S22	S22	105	138	1/23+1/28+2/40	F01B
	F020T836ZA75	80	2/2	850	850	S22	S22	125	145	1/25+1/30+2/41	F01B
	F020T850ZA75	80	2/2	850	850	S22	S22	90	137	1/23+1/28+2/39	F01B

BESTELNR N° COMMANDE ORDER NR BESTELLNR	BR LRG WID BR	BLADEN LAMES LEAVES BLATT.	B	C	D1	D2	PH FL FA SP	PAK EP TH PAK	DETAIL	MOD	OPMERKINGEN REMARQUES REMARKS BEMERKUNGEN
--	------------------------	-------------------------------------	---	---	----	----	----------------------	------------------------	--------	-----	--

SERIE : ATEGO**1525****voor-avant-front-Vorne**

F020T723ZA75	80	2	860	940	S18	S18	115	65	1/30+1/31	F01.70
F020T729ZA75	80	2	860	940	S18	S18	145	60	1/27+1/29	F01.70

achter-arrière-rear-Hinten

A	A020T890ZA76	80	11/P/11	850	850	S22	S22		295		A01A.70
	A020T890ZA75	80	11	850	850	S22	S22		143	11/13	A01.70
H	A020T890HA80	80	11/P	710	700	--	--		152	11/13+P/9	A08
	F020T836ZA75	80	2/2	850	850	S22	S22	125	145	1/25+1/30+2/41	F01B

1528**voor-avant-front-Vorne**

F020T701ZA75	80	2	860	940	S18	S18	150	61	1/27+1/28	F01.70
F020T723ZA75	80	2	860	940	S18	S18	115	65	1/30+1/31	F01.70
F020T729ZA75	80	2	860	940	S18	S18	145	60	1/27+1/29	F01.70

achter-arrière-rear-Hinten

A	A020T890ZA76	80	11/P/11	850	850	S22	S22		295		A01A.70
	A020T890ZA75	80	11	850	850	S22	S22		143	11/13	A01.70
H	A020T890HA80	80	11/P	710	700	--	--		152	11/13+P/9	A08
	F020T880ZA75	80	6	850	630	S22	S22	11	162	6/25	F01
	F020T900ZA75	80	2/2	850	850	S22	S22	105	138	1/23+1/28+2/40	F01B
	F020T850ZA75	80	2/2	850	850	S22	S22	90	137	1/23+1/28+2/39	F01B
	F020T836ZA75	80	2/2	850	850	S22	S22	125	145	1/25+1/30+2/41	F01B

BESTELNR N° COMMANDE ORDER NR BESTELNR	BR LRG WID BR	BLADEN LAMES LEAVES BLATT.	B	C	D1	D2	PH FL FA SP	PAK EP TH PAK	DETAIL	MOD	OPMERKINGEN REMARKS REMARKS BEMERKUNGEN
---	------------------------	-------------------------------------	---	---	----	----	----------------------	------------------------	--------	-----	--

SERIE : ATEGO

1823

voor-avant-front-Vorne

F020T669ZA75	90	2	900	900	S24	S24	116	62	2/28	F01
F020T665ZA75	90	3	900	900	S24	S24	122	78	1/22+2/25	F01
F020T663ZA75	90	3	900	900	S24	S24	130	80	1/24+2/25	F01
F020T659ZA75	90	3	900	900	S24	S24	160	79	1/22+2/24	F01
F020T649ZA75	90	3	900	900	S24	S24	140	81	1/22+2/25	F01
F020T647ZA75	90	3	900	900	S24	S24	142	86	1/25+2/26	F01
F020T637ZA75	90	3	900	900	S24	S24	150	77	1/22+2/23	F01
F020T671ZA75	90	3	900	900	S24	S24	102	92	1/28+2/29	F01
F020T713ZA75	90	3	970	830	S24	S24		81	1/23+2/25	F01
F020T731ZA75	90	3	970	830	S24	S24	94	90	3/28	F01
F020T709ZA75	90	2	900	900	S24	S24	121	58	2/27	F01.10
F020T711ZA75	90	2	900	900	S24	S24	123	60	2/28	F01.10

achter-arrière-rear-Hinten

F020T766ZA75	100	5	900	750	S24	S24		133	1/23+4/25	F01
F020T760ZA75	100	2/1	900	885	S24	S24	117	99	1/28+1/30+1/35	F01B
F020T764ZA75	100	3/1	900	885	S24	S24	90	133	1/23+2/28+1/46	F01B
F020T762ZA75	100	3/1	900	885	S24	S24	108	127	1/23+2/28+1/40	F01B

BESTELNR N° COMMANDE ORDER NR BESTELNR	BR LRG WID BR	BLADEN LAMES LEAVES BLATT.	B	C	D1	D2	PH FL FA SP	PAK EP TH PAK	DETAIL	MOD	OPMERKINGEN REMARQUES REMARKS BEMERKUNGEN
---	------------------------	-------------------------------------	---	---	----	----	----------------------	------------------------	--------	-----	--

SERIE : ATEGO

1828

voor-avant-front-Vorne

F020T669ZA75	90	2	900	900	S24	S24	116	62	2/28	F01
F020T637ZA75	90	3	900	900	S24	S24	150	77	1/22+2/23	F01
F020T671ZA75	90	3	900	900	S24	S24	102	92	1/28+2/29	F01
F020T665ZA75	90	3	900	900	S24	S24	122	78	1/22+2/25	F01
F020T663ZA75	90	3	900	900	S24	S24	130	80	1/24+2/25	F01
F020T659ZA75	90	3	900	900	S24	S24	160	79	1/22+2/24	F01
F020T649ZA75	90	3	900	900	S24	S24	140	81	1/22+2/25	F01
F020T647ZA75	90	3	900	900	S24	S24	142	86	1/25+2/26	F01
F020T713ZA75	90	3	970	830	S24	S24		81	1/23+2/25	F01
F020T731ZA75	90	3	970	830	S24	S24	94	90	3/28	F01
F020T711ZA75	90	2	900	900	S24	S24	123	60	2/28	F01.10
F020T709ZA75	90	2	900	900	S24	S24	121	58	2/27	F01.10

achter-arrière-rear-Hinten

F020T766ZA75	100	5	900	750	S24	S24		133	1/23+4/25	F01
F020T760ZA75	100	2/1	900	885	S24	S24	117	99	1/28+1/30+1/35	F01B
F020T764ZA75	100	3/1	900	885	S24	S24	90	133	1/23+2/28+1/46	F01B
F020T762ZA75	100	3/1	900	885	S24	S24	108	127	1/23+2/28+1/40	F01B

BESTELNR N° COMMANDE ORDER NR BESTELLNR	BR LRG WID BR	BLADEN LAMES LEAVES BLATT.	B	C	D1	D2	PH FL FA SP	PAK EP TH PAK	DETAIL	MOD	OPMERKINGEN REMARQUES REMARKS BEMERKUNGEN
--	------------------------	-------------------------------------	---	---	----	----	----------------------	------------------------	--------	-----	--

SERIE : DAIMLER-CHRY

MERCEDES AXLES

F001A037DR75											
F001A437HD75	100	1	530	512	S30	--		53	1/48	LK6754	4 gat tbk op onderk
F001A037DD75	100	2	530	430	S30	--	16	79	2/35	LR0271	Lenker
F001A437HR75	100	1	530	459	S30	--		53	1/48	LR5752	4 gat tbk op bovenk
F001A037IK75	100	1	565	404	S30	--	-36	59	1/54	LR5763	4 gat tbk op onderk
F001A037IQ75	100	1	565	404	S30	--	-36	59	1/54	LR5763	4 gat tbk op bovenk

BESTELNR N° COMMANDE ORDER NR BESTELNR	BR LRG WID BR	BLADEN LAMES LEAVES BLATT.	B	C	D1	D2	PH FL FA SP	PAK EP TH PAK	DETAIL	MOD	OPMERKINGEN REMARQUES REMARKS BEMERKUNGEN
---	------------------------	-------------------------------------	---	---	----	----	----------------------	------------------------	--------	-----	--

SERIE : SPRINTER 200

208CDI

achter-arrière-rear-Hinten

F020T732ZA75	70	1	740	755	S12	S12	115	24	1/24	F01.22
F020T698ZA75	70	1	740	755	S12	S12	145	21	1/21	F01.22
F020T704ZA75	70	1	740	755	S12	S12	135	23	1/23	F01.22

208D

voor-avant-front-Vorne

F020T633ZA70	110	1	650	650	--	--	155	15	1/15	F08T1
F020T625ZA70	110	1	650	650	--	--	150	15	1/15	F08T1
F020T631ZA70	100	2	650	650	--	--	150	27	2/13.5	F08T2
F020T629ZA70	100	2	650	650	--	--	140	26	2/13	F08T2

achter-arrière-rear-Hinten

F020T732ZA75	70	1	740	755	S12	S12	115	24	1/24	F01.22
F020T698ZA75	70	1	740	755	S12	S12	145	21	1/21	F01.22
F020T704ZA75	70	1	740	755	S12	S12	135	23	1/23	F01.22

210D

voor-avant-front-Vorne

F020T633ZA70	110	1	650	650	--	--	155	15	1/15	F08T1
F020T625ZA70	110	1	650	650	--	--	150	15	1/15	F08T1
F020T629ZA70	100	2	650	650	--	--	140	26	2/13	F08T2
F020T631ZA70	100	2	650	650	--	--	150	27	2/13.5	F08T2

achter-arrière-rear-Hinten

F020T698ZA75	70	1	740	755	S12	S12	145	21	1/21	F01.22
F020T704ZA75	70	1	740	755	S12	S12	135	23	1/23	F01.22
F020T732ZA75	70	1	740	755	S12	S12	115	24	1/24	F01.22

BESTELNR N° COMMANDE ORDER NR BESTELNR	BR LRG WID BR	BLADEN LAMES LEAVES BLATT.	B	C	D1	D2	PH FL FA SP	PAK EP TH PAK	DETAIL	MOD	OPMERKINGEN REMARQUES REMARKS BEMERKUNGEN
---	------------------------	-------------------------------------	---	---	----	----	----------------------	------------------------	--------	-----	--

SERIE : SPRINTER 200

211CDI

achter-arrière-rear-Hinten

F020T698ZA75	70	1	740	755	S12	S12	145	21	1/21	F01.22
F020T704ZA75	70	1	740	755	S12	S12	135	23	1/23	F01.22
F020T732ZA75	70	1	740	755	S12	S12	115	24	1/24	F01.22

212D

voor-avant-front-Vorne

F020T625ZA70	110	1	650	650	--	--	150	15	1/15	F08T1
F020T633ZA70	110	1	650	650	--	--	155	15	1/15	F08T1
F020T629ZA70	100	2	650	650	--	--	140	26	2/13	F08T2
F020T631ZA70	100	2	650	650	--	--	150	27	2/13.5	F08T2

achter-arrière-rear-Hinten

F020T734ZA75	70	1	740	750	S12	S12	70	27	1/27	F01.22
F020T698ZA75	70	1	740	755	S12	S12	145	21	1/21	F01.22
F020T704ZA75	70	1	740	755	S12	S12	135	23	1/23	F01.22
F020T732ZA75	70	1	740	755	S12	S12	115	24	1/24	F01.22

213CDI

achter-arrière-rear-Hinten

F020T732ZA75	70	1	740	755	S12	S12	115	24	1/24	F01.22
F020T698ZA75	70	1	740	755	S12	S12	145	21	1/21	F01.22
F020T704ZA75	70	1	740	755	S12	S12	135	23	1/23	F01.22

BESTELNR N° COMMANDE ORDER NR BESTELNR	BR LRG WID BR	BLADEN LAMES LEAVES BLATT.	B	C	D1	D2	PH FL FA SP	PAK EP TH PAK	DETAIL	MOD	OPMERKINGEN REMARKS REMARKS BEMERKUNGEN
---	------------------------	-------------------------------------	---	---	----	----	----------------------	------------------------	--------	-----	--

SERIE : SPRINTER 200**214****voor-avant-front-Vorne**

F020T625ZA70	110	1	650	650	--	--	150	15	1/15	F08T1
F020T633ZA70	110	1	650	650	--	--	155	15	1/15	F08T1
F020T629ZA70	100	2	650	650	--	--	140	26	2/13	F08T2
F020T631ZA70	100	2	650	650	--	--	150	27	2/13.5	F08T2

achter-arrière-rear-Hinten

F020T698ZA75	70	1	740	755	S12	S12	145	21	1/21	F01.22
F020T704ZA75	70	1	740	755	S12	S12	135	23	1/23	F01.22
F020T732ZA75	70	1	740	755	S12	S12	115	24	1/24	F01.22

216CDI**achter-arrière-rear-Hinten**

F020T704ZA75	70	1	740	755	S12	S12	135	23	1/23	F01.22
F020T732ZA75	70	1	740	755	S12	S12	115	24	1/24	F01.22

BESTELNR N° COMMANDE ORDER NR BESTELNR	BR LRG WID BR	BLADEN LAMES LEAVES BLATT.	B	C	D1	D2	PH FL FA SP	PAK EP TH PAK	DETAIL	MOD	OPMERKINGEN REMARQUES REMARKS BEMERKUNGEN
---	------------------------	-------------------------------------	---	---	----	----	----------------------	------------------------	--------	-----	--

SERIE : SPRINTER 300**308CDI****voor-avant-front-Vorne**

F020T629ZA70	100	2	650	650	--	--	140	26	2/13	F08T2
--------------	-----	---	-----	-----	----	----	-----	----	------	-------

achter-arrière-rear-Hinten

F020T734ZA75	70	1	740	750	S12	S12	70	27	1/27	F01.22
F020T886ZA75	70	1/1	740	750	S12	S12	135	39	1/19+1/20	F01.22
F020T736ZA75	70	1/1	740	750	S12	S12	95	39	1/16+1/23	F01.22
F020T674ZA75	70	1/1	740	750	S12	S12	135	39	1/19+1/20	F01.22
F020T868ZA75	70	1	740	755	S12	S12	115	25	1/25	F01.22
F020T870ZA75	70	1	740	755	S12	S12	51	30	1/30	F01.22
F020T884ZA75	70	1	740	755	S12	S12	120	25	1/25	F01.22
F020T732ZA75	70	1	740	755	S12	S12	115	24	1/24	F01.22
F020T662ZA75	70	1	740	755	S12	S12	120	25	1/25	F01.22
F020T866ZA75	70	1	740	755	S12	S12	135	25	1/25	F01.22
F020T872ZA75	70	2	740	755	S12	S12	110	39	1/18+1/21	F01.22
F020T874ZA75	70	2	740	755	S12	S12	80	39	1/16+1/23	F01.22
F020T914ZA75	70	2/1	740	755	S12	S12	145	46	1/11+1/17+1/18	F01.22

BESTELNR N° COMMANDE ORDER NR BESTELNR	BR LRG WID BR	BLADEN LAMES LEAVES BLATT.	B	C	D1	D2	PH FL FA SP	PAK EP TH PAK	DETAIL	MOD	OPMERKINGEN REMARKS REMARKS BEMERKUNGEN
---	------------------------	-------------------------------------	---	---	----	----	----------------------	------------------------	--------	-----	--

SERIE : SPRINTER 300**308D****voor-avant-front-Vorne**

F020T757ZA70	100	2	650	650	--	--	130	27	2/13.5	F08T2
F020T627ZA70	110	2	650	650	--	--	145	24	2/12	F08T2

achter-arrière-rear-Hinten

F020T734ZA75	70	1	740	750	S12	S12	70	27	1/27	F01.22
F020T886ZA75	70	1/1	740	750	S12	S12	135	39	1/19+1/20	F01.22
F020T674ZA75	70	1/1	740	750	S12	S12	135	39	1/19+1/20	F01.22
F020T736ZA75	70	1/1	740	750	S12	S12	95	39	1/16+1/23	F01.22
F020T884ZA75	70	1	740	755	S12	S12	120	25	1/25	F01.22
F020T662ZA75	70	1	740	755	S12	S12	120	25	1/25	F01.22
F020T732ZA75	70	1	740	755	S12	S12	115	24	1/24	F01.22
F020T872ZA75	70	2	740	755	S12	S12	110	39	1/18+1/21	F01.22
F020T874ZA75	70	2	740	755	S12	S12	80	39	1/16+1/23	F01.22
F020T914ZA75	70	2/1	740	755	S12	S12	145	46	1/11+1/17+1/18	F01.22

310D**voor-avant-front-Vorne**

F020T757ZA70	100	2	650	650	--	--	130	27	2/13.5	F08T2
F020T627ZA70	110	2	650	650	--	--	145	24	2/12	F08T2

achter-arrière-rear-Hinten

F020T734ZA75	70	1	740	750	S12	S12	70	27	1/27	F01.22
F020T886ZA75	70	1/1	740	750	S12	S12	135	39	1/19+1/20	F01.22
F020T736ZA75	70	1/1	740	750	S12	S12	95	39	1/16+1/23	F01.22
F020T674ZA75	70	1/1	740	750	S12	S12	135	39	1/19+1/20	F01.22
F020T732ZA75	70	1	740	755	S12	S12	115	24	1/24	F01.22
F020T884ZA75	70	1	740	755	S12	S12	120	25	1/25	F01.22
F020T662ZA75	70	1	740	755	S12	S12	120	25	1/25	F01.22
F020T874ZA75	70	2	740	755	S12	S12	80	39	1/16+1/23	F01.22
F020T872ZA75	70	2	740	755	S12	S12	110	39	1/18+1/21	F01.22
F020T914ZA75	70	2/1	740	755	S12	S12	145	46	1/11+1/17+1/18	F01.22

BESTELNR N° COMMANDE ORDER NR BESTELNR	BR LRG WID BR	BLADEN LAMES LEAVES BLATT.	B	C	D1	D2	PH FL FA SP	PAK EP TH PAK	DETAIL	MOD	OPMERKINGEN REMARQUES REMARKS BEMERKUNGEN
---	------------------------	-------------------------------------	---	---	----	----	----------------------	------------------------	--------	-----	--

SERIE : SPRINTER 300**311CDI****voor-avant-front-Vorne**

F020T629ZA70	100	2	650	650	--	--	140	26	2/13	F08T2
--------------	-----	---	-----	-----	----	----	-----	----	------	-------

achter-arrière-rear-Hinten

F020T734ZA75	70	1	740	750	S12	S12	70	27	1/27	F01.22
F020T736ZA75	70	1/1	740	750	S12	S12	95	39	1/16+1/23	F01.22
F020T886ZA75	70	1/1	740	750	S12	S12	135	39	1/19+1/20	F01.22
F020T674ZA75	70	1/1	740	750	S12	S12	135	39	1/19+1/20	F01.22
F020T866ZA75	70	1	740	755	S12	S12	135	25	1/25	F01.22
F020T868ZA75	70	1	740	755	S12	S12	115	25	1/25	F01.22
F020T870ZA75	70	1	740	755	S12	S12	51	30	1/30	F01.22
F020T884ZA75	70	1	740	755	S12	S12	120	25	1/25	F01.22
F020T662ZA75	70	1	740	755	S12	S12	120	25	1/25	F01.22
F020T732ZA75	70	1	740	755	S12	S12	115	24	1/24	F01.22
F020T872ZA75	70	2	740	755	S12	S12	110	39	1/18+1/21	F01.22
F020T874ZA75	70	2	740	755	S12	S12	80	39	1/16+1/23	F01.22
F020T914ZA75	70	2/1	740	755	S12	S12	145	46	1/11+1/17+1/18	F01.22

BESTELNR N° COMMANDE ORDER NR BESTELNR	BR LRG WID BR	BLADEN LAMES LEAVES BLATT.	B	C	D1	D2	PH FL FA SP	PAK EP TH PAK	DETAIL	MOD	OPMERKINGEN REMARQUES REMARKS BEMERKUNGEN
---	------------------------	-------------------------------------	---	---	----	----	----------------------	------------------------	--------	-----	--

SERIE : SPRINTER 300**312D****voor-avant-front-Vorne**

F020T757ZA70	100	2	650	650	--	--	130	27	2/13.5	F08T2
F020T627ZA70	110	2	650	650	--	--	145	24	2/12	F08T2

achter-arrière-rear-Hinten

F020T734ZA75	70	1	740	750	S12	S12	70	27	1/27	F01.22
F020T886ZA75	70	1/1	740	750	S12	S12	135	39	1/19+1/20	F01.22
F020T736ZA75	70	1/1	740	750	S12	S12	95	39	1/16+1/23	F01.22
F020T674ZA75	70	1/1	740	750	S12	S12	135	39	1/19+1/20	F01.22
F020T884ZA75	70	1	740	755	S12	S12	120	25	1/25	F01.22
F020T662ZA75	70	1	740	755	S12	S12	120	25	1/25	F01.22
F020T732ZA75	70	1	740	755	S12	S12	115	24	1/24	F01.22
F020T872ZA75	70	2	740	755	S12	S12	110	39	1/18+1/21	F01.22
F020T874ZA75	70	2	740	755	S12	S12	80	39	1/16+1/23	F01.22
F020T914ZA75	70	2/1	740	755	S12	S12	145	46	1/11+1/17+1/18	F01.22

BESTELNR N° COMMANDE ORDER NR BESTELNR	BR LRG WID BR	BLADEN LAMES LEAVES BLATT.	B	C	D1	D2	PH FL FA SP	PAK EP TH PAK	DETAIL	MOD	OPMERKINGEN REMARQUES REMARKS BEMERKUNGEN
---	------------------------	-------------------------------------	---	---	----	----	----------------------	------------------------	--------	-----	--

SERIE : SPRINTER 300**313CDI****voor-avant-front-Vorne**

F020T629ZA70	100	2	650	650	--	--	140	26	2/13	F08T2
--------------	-----	---	-----	-----	----	----	-----	----	------	-------

achter-arrière-rear-Hinten

F020T734ZA75	70	1	740	750	S12	S12	70	27	1/27	F01.22
F020T886ZA75	70	1/1	740	750	S12	S12	135	39	1/19+1/20	F01.22
F020T736ZA75	70	1/1	740	750	S12	S12	95	39	1/16+1/23	F01.22
F020T674ZA75	70	1/1	740	750	S12	S12	135	39	1/19+1/20	F01.22
F020T732ZA75	70	1	740	755	S12	S12	115	24	1/24	F01.22
F020T662ZA75	70	1	740	755	S12	S12	120	25	1/25	F01.22
F020T884ZA75	70	1	740	755	S12	S12	120	25	1/25	F01.22
F020T870ZA75	70	1	740	755	S12	S12	51	30	1/30	F01.22
F020T868ZA75	70	1	740	755	S12	S12	115	25	1/25	F01.22
F020T866ZA75	70	1	740	755	S12	S12	135	25	1/25	F01.22
F020T872ZA75	70	2	740	755	S12	S12	110	39	1/18+1/21	F01.22
F020T874ZA75	70	2	740	755	S12	S12	80	39	1/16+1/23	F01.22
F020T914ZA75	70	2/1	740	755	S12	S12	145	46	1/11+1/17+1/18	F01.22

BESTELNR N° COMMANDE ORDER NR BESTELNR	BR LRG WID BR	BLADEN LAMES LEAVES BLATT.	B	C	D1	D2	PH FL FA SP	PAK EP TH PAK	DETAIL	MOD	OPMERKINGEN REMARQUES REMARKS BEMERKUNGEN
---	------------------------	-------------------------------------	---	---	----	----	----------------------	------------------------	--------	-----	--

SERIE : SPRINTER 300**314****voor-avant-front-Vorne**

F020T629ZA70	100	2	650	650	--	--	140	26	2/13	F08T2
F020T757ZA70	100	2	650	650	--	--	130	27	2/13.5	F08T2
F020T627ZA70	110	2	650	650	--	--	145	24	2/12	F08T2

achter-arrière-rear-Hinten

F020T734ZA75	70	1	740	750	S12	S12	70	27	1/27	F01.22
F020T674ZA75	70	1/1	740	750	S12	S12	135	39	1/19+1/20	F01.22
F020T886ZA75	70	1/1	740	750	S12	S12	135	39	1/19+1/20	F01.22
F020T736ZA75	70	1/1	740	750	S12	S12	95	39	1/16+1/23	F01.22
F020T884ZA75	70	1	740	755	S12	S12	120	25	1/25	F01.22
F020T870ZA75	70	1	740	755	S12	S12	51	30	1/30	F01.22
F020T868ZA75	70	1	740	755	S12	S12	115	25	1/25	F01.22
F020T866ZA75	70	1	740	755	S12	S12	135	25	1/25	F01.22
F020T662ZA75	70	1	740	755	S12	S12	120	25	1/25	F01.22
F020T732ZA75	70	1	740	755	S12	S12	115	24	1/24	F01.22
F020T872ZA75	70	2	740	755	S12	S12	110	39	1/18+1/21	F01.22
F020T874ZA75	70	2	740	755	S12	S12	80	39	1/16+1/23	F01.22
F020T914ZA75	70	2/1	740	755	S12	S12	145	46	1/11+1/17+1/18	F01.22

BESTELNR N° COMMANDE ORDER NR BESTELNR	BR LRG WID BR	BLADEN LAMES LEAVES BLATT.	B	C	D1	D2	PH FL FA SP	PAK EP TH PAK	DETAIL	MOD	OPMERKINGEN REMARQUES REMARKS BEMERKUNGEN
---	------------------------	-------------------------------------	---	---	----	----	----------------------	------------------------	--------	-----	--

SERIE : SPRINTER 300**316CDI****voor-avant-front-Vorne**

F020T629ZA70	100	2	650	650	--	--	140	26	2/13	F08T2
--------------	-----	---	-----	-----	----	----	-----	----	------	-------

achter-arrière-rear-Hinten

F020T734ZA75	70	1	740	750	S12	S12	70	27	1/27	F01.22
F020T674ZA75	70	1/1	740	750	S12	S12	135	39	1/19+1/20	F01.22
F020T736ZA75	70	1/1	740	750	S12	S12	95	39	1/16+1/23	F01.22
F020T886ZA75	70	1/1	740	750	S12	S12	135	39	1/19+1/20	F01.22
F020T870ZA75	70	1	740	755	S12	S12	51	30	1/30	F01.22
F020T662ZA75	70	1	740	755	S12	S12	120	25	1/25	F01.22
F020T732ZA75	70	1	740	755	S12	S12	115	24	1/24	F01.22
F020T866ZA75	70	1	740	755	S12	S12	135	25	1/25	F01.22
F020T868ZA75	70	1	740	755	S12	S12	115	25	1/25	F01.22
F020T884ZA75	70	1	740	755	S12	S12	120	25	1/25	F01.22
F020T872ZA75	70	2	740	755	S12	S12	110	39	1/18+1/21	F01.22
F020T874ZA75	70	2	740	755	S12	S12	80	39	1/16+1/23	F01.22
F020T914ZA75	70	2/1	740	755	S12	S12	145	46	1/11+1/17+1/18	F01.22

BESTELNR N° COMMANDE ORDER NR BESTELNR	BR LRG WID BR	BLADEN LAMES LEAVES BLATT.	B	C	D1	D2	PH FL FA SP	PAK EP TH PAK	DETAIL	MOD	OPMERKINGEN REMARKS REMARKS BEMERKUNGEN
---	------------------------	-------------------------------------	---	---	----	----	----------------------	------------------------	--------	-----	--

SERIE : SPRINTER 400**408CDI****voor-avant-front-Vorne**

F020T631ZA70	100	2	650	650	--	--	150	27	2/13.5	F08T2	
--------------	-----	---	-----	-----	----	----	-----	----	--------	-------	--

achter-arrière-rear-Hinten

F020T876ZA75	70	1	740	750	S16	S16	47	33	1/33	F01.70	Silentbloc
F020T738ZA75	70	1	740	750	S16	S16	48	33	1/33	F01.70	Silentbloc
F020T818ZA75	70	2	740	750	S16	S16		47	1/19+1/28	F01.70	Silentbloc
F020T878ZA75	70	2/1	740	750	S16	S16		54	1/12+1/15.5+1/27	F01B.70	
F020T856ZA75	70	2/1	740	750	S16	S16	153	55	1/12+1/15.5+1/28	F01B.70	verschillende SB's
F020T718ZA75	70	2/1	740	750	S16	S16	126	52	1/12+1/15.5+1/25	F01B.70	glijdop/pastille
F020T680ZA75	70	2/1	740	750	S16	S16	153	55	1/12+1/15.5+1/28	F01B.70	glijdop/pastille
F020T918ZA75	70	2/1	740	750	S16	S16	145	54	1/12+1/15.5+1/27	F01B.70	

408D**achter-arrière-rear-Hinten**

F020T876ZA75	70	1	740	750	S16	S16	47	33	1/33	F01.70	Silentbloc
F020T738ZA75	70	1	740	750	S16	S16	48	33	1/33	F01.70	Silentbloc
F020T818ZA75	70	2	740	750	S16	S16		47	1/19+1/28	F01.70	Silentbloc
F020T856ZA75	70	2/1	740	750	S16	S16	153	55	1/12+1/15.5+1/28	F01B.70	verschillende SB's
F020T918ZA75	70	2/1	740	750	S16	S16	145	54	1/12+1/15.5+1/27	F01B.70	
F020T718ZA75	70	2/1	740	750	S16	S16	126	52	1/12+1/15.5+1/25	F01B.70	glijdop/pastille
F020T680ZA75	70	2/1	740	750	S16	S16	153	55	1/12+1/15.5+1/28	F01B.70	glijdop/pastille
F020T878ZA75	70	2/1	740	750	S16	S16		54	1/12+1/15.5+1/27	F01B.70	

BESTELNR N° COMMANDE ORDER NR BESTELNR	BR LRG WID BR	BLADEN LAMES LEAVES BLATT.	B	C	D1	D2	PH FL FA SP	PAK EP TH PAK	DETAIL	MOD	OPMERKINGEN REMARQUES REMARKS BEMERKUNGEN
---	------------------------	-------------------------------------	---	---	----	----	----------------------	------------------------	--------	-----	--

SERIE : SPRINTER 400

410D

voor-avant-front-Vorne

F020T633ZA70	110	1	650	650	--	--	155	15	1/15	F08T1
--------------	-----	---	-----	-----	----	----	-----	----	------	-------

achter-arrière-rear-Hinten

F020T876ZA75	70	1	740	750	S16	S16	47	33	1/33	F01.70	Silentbloc
F020T738ZA75	70	1	740	750	S16	S16	48	33	1/33	F01.70	Silentbloc
F020T818ZA75	70	2	740	750	S16	S16		47	1/19+1/28	F01.70	Silentbloc
F020T918ZA75	70	2/1	740	750	S16	S16	145	54	1/12+1/15.5+1/27	F01B.70	
F020T878ZA75	70	2/1	740	750	S16	S16		54	1/12+1/15.5+1/27	F01B.70	
F020T856ZA75	70	2/1	740	750	S16	S16	153	55	1/12+1/15.5+1/28	F01B.70	verschillende SB's
F020T680ZA75	70	2/1	740	750	S16	S16	153	55	1/12+1/15.5+1/28	F01B.70	glijdop/pastille
F020T718ZA75	70	2/1	740	750	S16	S16	126	52	1/12+1/15.5+1/25	F01B.70	glijdop/pastille

411CDI

voor-avant-front-Vorne

F020T631ZA70	100	2	650	650	--	--	150	27	2/13.5	F08T2
--------------	-----	---	-----	-----	----	----	-----	----	--------	-------

achter-arrière-rear-Hinten

F020T738ZA75	70	1	740	750	S16	S16	48	33	1/33	F01.70	Silentbloc
F020T876ZA75	70	1	740	750	S16	S16	47	33	1/33	F01.70	Silentbloc
F020T818ZA75	70	2	740	750	S16	S16		47	1/19+1/28	F01.70	Silentbloc
F020T856ZA75	70	2/1	740	750	S16	S16	153	55	1/12+1/15.5+1/28	F01B.70	verschillende SB's
F020T680ZA75	70	2/1	740	750	S16	S16	153	55	1/12+1/15.5+1/28	F01B.70	glijdop/pastille
F020T878ZA75	70	2/1	740	750	S16	S16		54	1/12+1/15.5+1/27	F01B.70	
F020T918ZA75	70	2/1	740	750	S16	S16	145	54	1/12+1/15.5+1/27	F01B.70	
F020T718ZA75	70	2/1	740	750	S16	S16	126	52	1/12+1/15.5+1/25	F01B.70	glijdop/pastille

BESTELNR N° COMMANDE ORDER NR BESTELNR	BR LRG WID BR	BLADEN LAMES LEAVES BLATT.	B	C	D1	D2	PH FL FA SP	PAK EP TH PAK	DETAIL	MOD	OPMERKINGEN REMARQUES REMARKS BEMERKUNGEN
---	------------------------	-------------------------------------	---	---	----	----	----------------------	------------------------	--------	-----	--

SERIE : SPRINTER 400**412D****voor-avant-front-Vorne**

F020T633ZA70	110	1	650	650	--	--	155	15	1/15	F08T1
--------------	-----	---	-----	-----	----	----	-----	----	------	-------

achter-arrière-rear-Hinten

F020T876ZA75	70	1	740	750	S16	S16	47	33	1/33	F01.70	Silentbloc
F020T738ZA75	70	1	740	750	S16	S16	48	33	1/33	F01.70	Silentbloc
F020T818ZA75	70	2	740	750	S16	S16		47	1/19+1/28	F01.70	Silentbloc
F020T878ZA75	70	2/1	740	750	S16	S16		54	1/12+1/15.5+1/27	F01B.70	
F020T918ZA75	70	2/1	740	750	S16	S16	145	54	1/12+1/15.5+1/27	F01B.70	
F020T718ZA75	70	2/1	740	750	S16	S16	126	52	1/12+1/15.5+1/25	F01B.70	glijdop/pastille
F020T680ZA75	70	2/1	740	750	S16	S16	153	55	1/12+1/15.5+1/28	F01B.70	glijdop/pastille
F020T856ZA75	70	2/1	740	750	S16	S16	153	55	1/12+1/15.5+1/28	F01B.70	verschillende SB's

413CDI**voor-avant-front-Vorne**

F020T631ZA70	100	2	650	650	--	--	150	27	2/13.5	F08T2
--------------	-----	---	-----	-----	----	----	-----	----	--------	-------

achter-arrière-rear-Hinten

F020T876ZA75	70	1	740	750	S16	S16	47	33	1/33	F01.70	Silentbloc
F020T738ZA75	70	1	740	750	S16	S16	48	33	1/33	F01.70	Silentbloc
F020T818ZA75	70	2	740	750	S16	S16		47	1/19+1/28	F01.70	Silentbloc
F020T878ZA75	70	2/1	740	750	S16	S16		54	1/12+1/15.5+1/27	F01B.70	
F020T718ZA75	70	2/1	740	750	S16	S16	126	52	1/12+1/15.5+1/25	F01B.70	glijdop/pastille
F020T680ZA75	70	2/1	740	750	S16	S16	153	55	1/12+1/15.5+1/28	F01B.70	glijdop/pastille
F020T918ZA75	70	2/1	740	750	S16	S16	145	54	1/12+1/15.5+1/27	F01B.70	
F020T856ZA75	70	2/1	740	750	S16	S16	153	55	1/12+1/15.5+1/28	F01B.70	verschillende SB's

BESTELNR N° COMMANDE ORDER NR BESTELNR	BR LRG WID BR	BLADEN LAMES LEAVES BLATT.	B	C	D1	D2	PH FL FA SP	PAK EP TH PAK	DETAIL	MOD	OPMERKINGEN REMARQUES REMARKS BEMERKUNGEN
---	------------------------	-------------------------------------	---	---	----	----	----------------------	------------------------	--------	-----	--

SERIE : SPRINTER 400**414****voor-avant-front-Vorne**

F020T633ZA70	110	1	650	650	--	--	155	15	1/15	F08T1
F020T631ZA70	100	2	650	650	--	--	150	27	2/13.5	F08T2

achter-arrière-rear-Hinten

F020T876ZA75	70	1	740	750	S16	S16	47	33	1/33	F01.70	Silentbloc
F020T738ZA75	70	1	740	750	S16	S16	48	33	1/33	F01.70	Silentbloc
F020T818ZA75	70	2	740	750	S16	S16		47	1/19+1/28	F01.70	Silentbloc
F020T856ZA75	70	2/1	740	750	S16	S16	153	55	1/12+1/15.5+1/28	F01B.70	verschillende SB's
F020T878ZA75	70	2/1	740	750	S16	S16		54	1/12+1/15.5+1/27	F01B.70	
F020T718ZA75	70	2/1	740	750	S16	S16	126	52	1/12+1/15.5+1/25	F01B.70	glijdop/pastille
F020T680ZA75	70	2/1	740	750	S16	S16	153	55	1/12+1/15.5+1/28	F01B.70	glijdop/pastille
F020T918ZA75	70	2/1	740	750	S16	S16	145	54	1/12+1/15.5+1/27	F01B.70	

416CDI**voor-avant-front-Vorne**

F020T631ZA70	100	2	650	650	--	--	150	27	2/13.5	F08T2
--------------	-----	---	-----	-----	----	----	-----	----	--------	-------

achter-arrière-rear-Hinten

F020T738ZA75	70	1	740	750	S16	S16	48	33	1/33	F01.70	Silentbloc
F020T876ZA75	70	1	740	750	S16	S16	47	33	1/33	F01.70	Silentbloc
F020T818ZA75	70	2	740	750	S16	S16		47	1/19+1/28	F01.70	Silentbloc
F020T918ZA75	70	2/1	740	750	S16	S16	145	54	1/12+1/15.5+1/27	F01B.70	
F020T878ZA75	70	2/1	740	750	S16	S16		54	1/12+1/15.5+1/27	F01B.70	
F020T856ZA75	70	2/1	740	750	S16	S16	153	55	1/12+1/15.5+1/28	F01B.70	verschillende SB's
F020T680ZA75	70	2/1	740	750	S16	S16	153	55	1/12+1/15.5+1/28	F01B.70	glijdop/pastille
F020T718ZA75	70	2/1	740	750	S16	S16	126	52	1/12+1/15.5+1/25	F01B.70	glijdop/pastille

BESTELNR N° COMMANDE ORDER NR BESTELLNR	BR LRG WID BR	BLADEN LAMES LEAVES BLATT.	B	C	D1	D2	PH FL FA SP	PAK EP TH PAK	DETAIL	MOD	OPMERKINGEN REMARQUES REMARKS BEMERKUNGEN
--	------------------------	-------------------------------------	---	---	----	----	----------------------	------------------------	--------	-----	--

SERIE : *SPRINTER 600*

616CDI

achter-arrière-rear-Hinten

F020T920ZA75	70	2/1	740	750	S18	S16	110	66	1/14+1/18+1/34	F01B.70
F020T896ZA75	70	2/1	740	750	S18	S16	130	65	1/13+1/17+1/34	F01B.70



DIAM	DR	BESTELNUMMER N° DE CDE ORDER NUMBER BESTELLNR	B(1)	B(2)	L(1)	L(2)	HD(1)	HD(2)	PL	OPMERKINGEN REMARQUES REMARKS BEMERKUNGEN
------	----	--	------	------	------	------	-------	-------	----	--

Vorm* : B05

(*) Vorm : Forme/Shape/Form

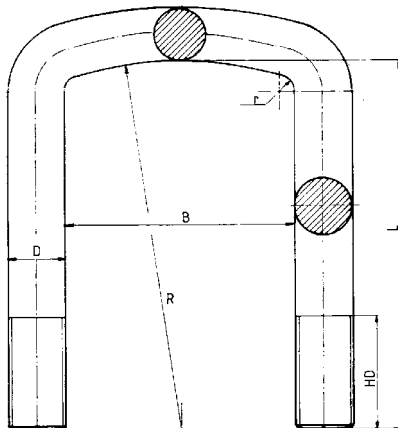

20.0	M20*1.5	B020M20A022	91		265		120			MERCEDES
	M20*1.5	B020M20A023	91		295		120			MERCEDES



DIAM	DR	BESTELNUMMER N° DE CDE ORDER NUMBER BESTELLNR	B(1)	B(2)	L(1)	L(2)	HD(1)	HD(2)	PL	OPMERKINGEN REMARQUES REMARKS BEMERKUNGEN
------	----	--	------	------	------	------	-------	-------	----	--

Vorm* : B0501

(*) *Vorm : Forme/Shape/Form*

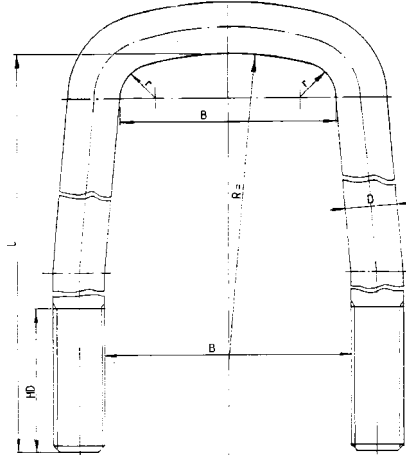

20.0	M20*1.5	B020M20A009	91	106	450		180			MERCEDES
------	---------	-------------	----	-----	-----	--	-----	--	--	----------



DIAM	DR	BESTELNUMMER N° DE CDE ORDER NUMBER BESTELLNR	B(1)	B(2)	L(1)	L(2)	HD(1)	HD(2)	PL	OPMERKINGEN REMARQUES REMARKS BEMERKUNGEN
------	----	--	------	------	------	------	-------	-------	----	--

Vorm* : B0701

(*) Vorm : Forme/Shape/Form

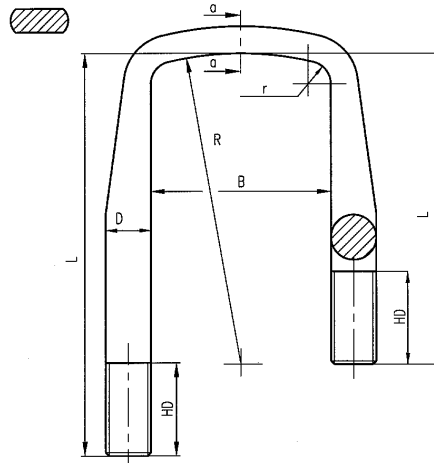

20.0	M20*1.5	B020M20B090	91		255	375	85			MERCEDES
	M20*1.5	B020M20B061	91		285	350	80	100		MERCEDES
	M20*1.5	B020M20B092	91		300	380	90			MERCEDES
	M20*1.5	B020M20B084	91		320	380	80	100		MERCEDES
24.0	M24*1.5	B020M24B017	102		385	470	70	150	100	MERCEDES



DIAM	DR	BESTELNUMMER N° DE CDE ORDER NUMBER BESTELLNR	B(1)	B(2)	L(1)	L(2)	HD(1)	HD(2)	PL	OPMERKINGEN REMARQUES REMARKS BEMERKUNGEN
------	----	--	------	------	------	------	-------	-------	----	--

Vorm* : B08

(*) *Vorm : Forme/Shape/Form*

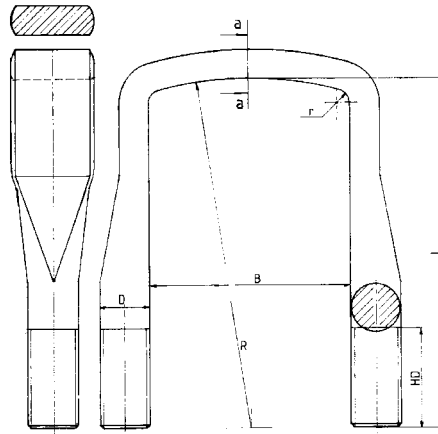

12.0	M12*1.5	B020M12B008	62		160	90	30			MERCEDES
12.0	M12*1.5	B020M12B009	72		145	40	40			MERCEDES
	M12*1.5	B020M12B012	72		170	80	40			MERCEDES
	M12*1.5	B020M12B007	72		195	45	40	B020M12B011		MERCEDES
	M12*1.5	B020M12B011	72		220	80	40			MERCEDES
14.0	M14*1.5	B020M14B002	72		95	50	30			MERCEDES
18.0	M18*1.5	B020M18B050	82		225	85	90			MERCEDES
	M18*1.5	B020M18B053	82		240	85	90			MERCEDES
	M18*1.5	B020M18B055	82		260	85	90			MERCEDES
	M18*1.5	B020M18B063	82		330	85	90	B020M18B006		MERCEDES
	M18*1.5	B020M18B006	82		360	120	90			MERCEDES
	M18*1.5	B020M18B002	82		400	120	90			MERCEDES
	M18*1.5	B020M18B072	82		400	85	90	B020M18B003		MERCEDES
	M18*1.5	B020M18B003	82		420	120	90			MERCEDES
	M18*1.5	B020M18B007	82		460	130	90			MERCEDES
20.0	M20*1.5	B020M20B037	81		330	70	30			MERCEDES
	M20*1.5	B020M20B038	81		350	70	30			MERCEDES
	M20*1.5	B020M20B062	81		360	70	30			MERCEDES
	M20*1.5	B020M20B063	81		380	70	30			MERCEDES
	M20*1.5	B020M20B012	81		450	120	30			MERCEDES
	M20*1.5	B020M20B069	81		530	120	30			MERCEDES



DIAM	DR	BESTELNUMMER N° DE CDE ORDER NUMBER BESTELLNR	B(1)	B(2)	L(1)	L(2)	HD(1)	HD(2)	PL	OPMERKINGEN REMARQUES REMARKS BEMERKUNGEN
------	----	--	------	------	------	------	-------	-------	----	--

Vorm* : B08

(*) Vorm : Forme/Shape/Form

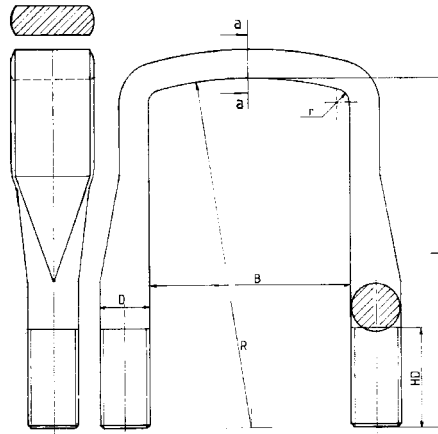

20.0	M20*1.5	B020M20B047	92		210	80	30			MERCEDES
	M20*1.5	B020M20B029	92		230	80	30			MERCEDES
	M20*1.5	B020M20B050	92		245	80	30	B020M20B072		MERCEDES
	M20*1.5	B020M20B051	92		260	80	30	B020M20B072		MERCEDES
	M20*1.5	B020M20B027	92		280	80	30	B020M20B072		MERCEDES
	M20*1.5	B020M20B009	92		290	80	30	B020M20B072		MERCEDES
	M20*1.5	B020M20B002	92		310	80	30	B020M20B072		MERCEDES
	M20*1.5	B020M20B072	92		310	140	30			MERCEDES
	M20*1.5	B020M20B028	92		330	80	30			MERCEDES
	M20*1.5	B020M20B013	92		350	100	30			MERCEDES
	M20*1.5	B020M20B033	92		385	80	30	B020M20B026		MERCEDES
	M20*1.5	B020M20B081	92		400	140	30			MERCEDES
	M20*1.5	B020M20B053	92		420	80	30	B020M20B026		MERCEDES
	M20*1.5	B020M20B026	92		430	120	30			MERCEDES
	M20*1.5	B020M20B080	92		460	120	30			MERCEDES
	M20*1.5	B020M20B083	92		535	120	30			MERCEDES

24.0	M24*1.5	B020M24B057	102		450	80	30	B152M24B020		MERCEDES
	M24*1.5	B152M24B020	102		475	120	30			MERCEDES
	M24*1.5	B020M24B046	102		520	120	30			MERCEDES
	M24*1.5	B020M24B055	102		550	120	30			MERCEDES
	M24*1.5	B020M24B086	102		575	90	30	B020M24B033		MERCEDES
	M24*1.5	B020M24B136	102		575	185	30			MERCEDES
	M24*1.5	B020M24B033	102		610	120	30			MERCEDES
	M24*1.5	B020M24B089	102		625	90	30	B020M24B048		MERCEDES
	M24*1.5	B020M24B048	102		660	120	30			MERCEDES



DIAM	DR	BESTELNUMMER N° DE CDE ORDER NUMBER BESTELLNr	B(1)	B(2)	L(1)	L(2)	HD(1)	HD(2)	PL	OPMERKINGEN REMARQUES REMARKS BEMERKUNGEN
------	----	--	------	------	------	------	-------	-------	----	--

Vorm* : B08

(*) *Vorm : Forme/Shape/Form*

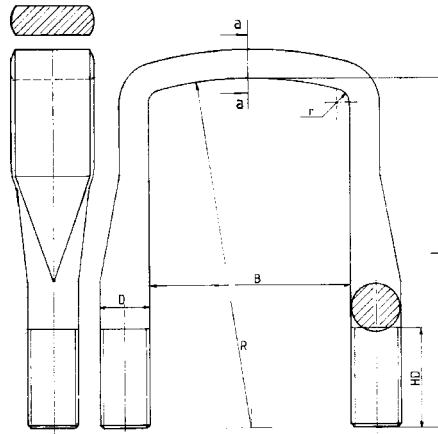



DIAM	DR	BESTELNUMMER N° DE CDE ORDER NUMBER BESTELLNR	B(1)	B(2)	L(1)	L(2)	HD(1)	HD(2)	PL	OPMERKINGEN REMARQUES REMARKS BEMERKUNGEN
------	----	--	------	------	------	------	-------	-------	----	--

Vorm* : B10

(*) Vorm : Forme/Shape/Form

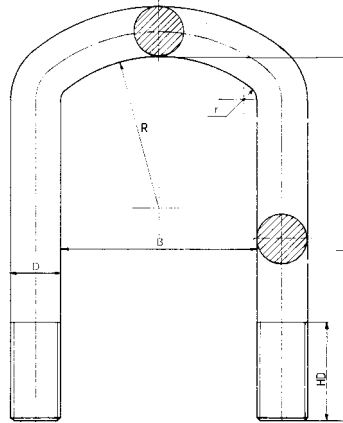

12.0	M12*1.5	B020M12A029	62		70		40			MERCEDES
	M12*1.5	B020M12A021	62		90		40			MERCEDES
	M12*1.5	B020M12A020	62		115		50			MERCEDES
	M12*1.5	B020M12A030	62		125		50		B020M12A014	MERCEDES
	M12*1.5	B020M12A014	62		130		50			MERCEDES
	M12*1.5	B020M12A023	62		160		50			MERCEDES
	M12*1.5	B020M12A005	62		200		80			MERCEDES
	M12*1.5	B020M12A006	62		220		80			MERCEDES
	M12*1.5	B020M12A012	62		230		80		B020M12A025	MERCEDES
	M12*1.5	B020M12A025	62		240		80			MERCEDES
	M12*1.5	B020M12A008	62		250		80			MERCEDES
14.0	M14*1.5	B020M14A009	72		140		80			MERCEDES
	M14*1.5	B020M14A001	72		175		55			MERCEDES
	M14*1.5	B020M14A002	72		205		55			MERCEDES
	M14*1.5	B020M14A003	72		260		60			MERCEDES
14.0	M14*1.5	B020M14A015	73		225		100			MERCEDES
16.0	M16*1.5	B020M16A081	62		270		70			MERCEDES
16.0	M16*1.5	B020M16A093	72		155		55			MERCEDES
	M16*1.5	B020M16A095	72		180		55			MERCEDES
	M16*1.5	B020M16A097	72		200		55			MERCEDES
	M16*1.5	B020M16A101	72		235		55			MERCEDES
	M16*1.5	B020M16A107	72		300		70			MERCEDES



DIAM	DR	BESTELNUMMER N° DE CDE ORDER NUMBER BESTELLNR	B(1)	B(2)	L(1)	L(2)	HD(1)	HD(2)	PL	OPMERKINGEN REMARQUES REMARKS BEMERKUNGEN
------	----	--	------	------	------	------	-------	-------	----	--

Vorm* : B10

(*) Vorm : Forme/Shape/Form

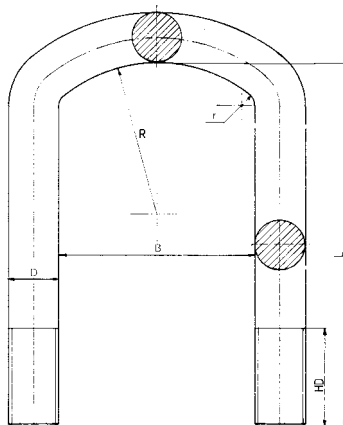

16.0	M16*1.5	B020M16A119	82		180		55			MERCEDES
	M16*1.5	B020M16A121	82		200		55			MERCEDES
	M16*1.5	B020M16A123	82		220		55			MERCEDES
	M16*1.5	B020M16A125	82		240		55			MERCEDES
	M16*1.5	B020M16A127	82		275		65			MERCEDES
	M16*1.5	B020M16A128	82		300		75			MERCEDES
	M16*1.5	B020M16A141	82		400		150			MERCEDES
18.0	M18*1.5	B020M18A063	72		190		55			MERCEDES
	M18*1.5	B020M18A065	72		210		55			MERCEDES
	M18*1.5	B020M18A069	72		240		55			MERCEDES
18.0	M18*1.5	B020M18A042	82		350		100			MERCEDES
	M18*1.5	B020M18A097	82		365		60			MERCEDES
	M18*1.5	B020M18A120	82		380		150			MERCEDES
	M18*1.5	B020M18A047	82		470		120			MERCEDES
20.0	M20*1.5	B020M20A004	92		260		60			MERCEDES



DIAM	DR	BESTELNUMMER N° DE CDE ORDER NUMBER BESTELLNR	B(1)	B(2)	L(1)	L(2)	HD(1)	HD(2)	PL	OPMERKINGEN REMARQUES REMARKS BEMERKUNGEN
------	----	--	------	------	------	------	-------	-------	----	--

Vorm* : B16

(*) *Vorm : Forme/Shape/Form*

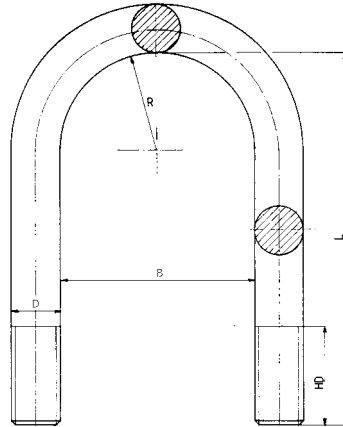

14.0	M14*1.5	B020M14A011	75		135		55			MERCEDES
	M14*1.5	B020M14A008	75		170		70			MERCEDES
	M14*1.5	B020M14A005	75		180		80			MERCEDES
	M14*1.5	B020M14A016	75		215		60			MERCEDES
	M14*1.5	B020M14A006	75		240		80			MERCEDES
24.0	M24*1.5	B020M24A008	91		380		90			MERCEDES
	M24*1.5	B020M24A010	91		470		120			MERCEDES
24.0	M24*1.5	B020M24A013	92		300		105			MERCEDES
	M24*1.5	B020M24A014	92		340		90			MERCEDES
24.0	M24*1.5	B020M24A007	156		390		30			MERCEDES



DIAM	DR	BESTELNUMMER N° DE CDE ORDER NUMBER BESTELLNR	B(1)	B(2)	L(1)	L(2)	HD(1)	HD(2)	PL	OPMERKINGEN REMARQUES REMARKS BEMERKUNGEN
------	----	--	------	------	------	------	-------	-------	----	--

Vorm* : B17

(*) *Vorm : Forme/Shape/Form*

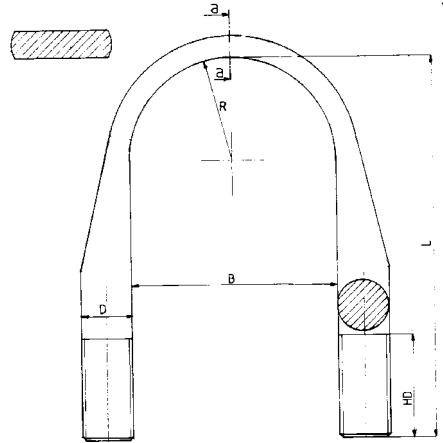

20.0	M20*1.5	B020M20B079	82		490		150		110	MERCEDES
	M20*1.5	B020M20B088	82		540		150		110	MERCEDES



DIAM	DR	BESTELNUMMER N° DE CDE ORDER NUMBER BESTELLNR	B(1)	B(2)	L(1)	L(2)	HD(1)	HD(2)	PL	OPMERKINGEN REMARQUES REMARKS BEMERKUNGEN
------	----	--	------	------	------	------	-------	-------	----	--

Vorm* : B18

(*) *Vorm : Forme/Shape/Form*

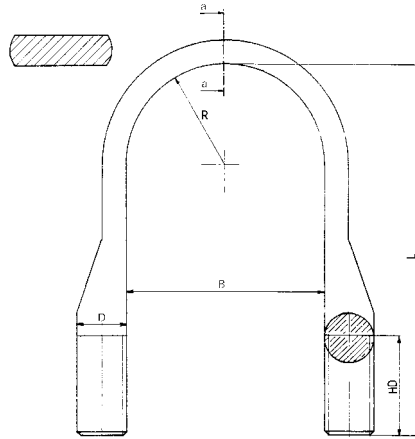

24.0	M24*1.5	B020M24B138	91		305		65		180	MERCEDES
	M24*1.5	B020M24B140	91		350		85		180	MERCEDES
	M24*1.5	B020M24B141	91		370		85		180	MERCEDES
24.0	M24*1.5	B020M24B117	101		335		80		175	MERCEDES
	M24*1.5	B020M24B049	101		365		80		175	B020M24B065 MERCEDES
	M24*1.5	B020M24B065	101		380		100		175	MERCEDES
	M24*1.5	B020M24B121	101		410		80		175	B020M24B059 MERCEDES
	M24*1.5	B020M24B062	101		425		100		175	B020M24B059 MERCEDES
	M24*1.5	B020M24B059	101		435		105		230	MERCEDES
	M24*1.5	B020M24B040	101		445		80		230	B020M24B135 MERCEDES
	M24*1.5	B020M24B060	101		465		105		230	B020M24B135 MERCEDES
	M24*1.5	B020M24B061	101		485		100		230	B020M24B135 MERCEDES
	M24*1.5	B020M24B135	101		510		150		230	MERCEDES
27.0	M27*2	B020M27B001	102		383		75		250	MERCEDES
	M27*2	B020M27B002	102		415		75		250	MERCEDES
	M27*2	B020M27B004	102		430		75		250	MERCEDES
	M27*2	B020M27B003	102		450		75		250	MERCEDES



DIAM	DR	BESTELNUMMER N° DE CDE ORDER NUMBER BESTELLNR	B(1)	B(2)	L(1)	L(2)	HD(1)	HD(2)	PL	OPMERKINGEN REMARQUES REMARKS BEMERKUNGEN
------	----	--	------	------	------	------	-------	-------	----	--

Vorm* : CZF012

(*) Vorm : Forme/Shape/Form

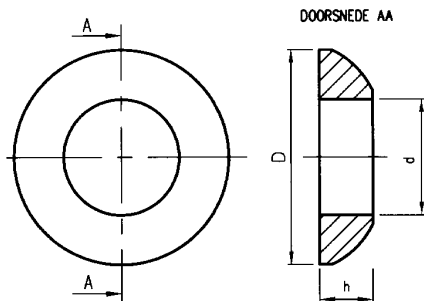

27.0		C301439-16	16		8					MERCEDES
29.0		C301439-18	18		8					MERCEDES
35.0		C301439-24.1	24		10					MERCEDES
38.0		C301439-24.2	24		12					MERCEDES



	Vorm	Dia	B(1)	B(2)	L(1)	L(2)	HD1	HD2
A020B024ZA75	Veerstrop ; Bride ; U Bolt ; Federbride :							
	B020M12A024	B10	12.0	62		180	60	
A020T103ZA75	Veerstrop ; Bride ; U Bolt ; Federbride :							
	B020M20B027	B08	20.0	92		280	80	
	Pen ; Axe ; Pin ; Bolzen :							
	YC020FB5453	in B, C en D						
A020T104AA70	Veerstrop ; Bride ; U Bolt ; Federbride :							
	B020M24B117	B18	24.0	101		335	80	
A020T104ZA70	Veerstrop ; Bride ; U Bolt ; Federbride :							
	B020M24B117	B18	24.0	101		335	80	
	B020M24B049	B18	24.0	101		365	80	
	B020M24B065	B18	24.0	101		380	100	
A020T162ZA76	Pen ; Axe ; Pin ; Bolzen :							
	YC020FB4806	boutset						
	YC020FB5487	boutset+bus						
A020T167ZA75	Veerstrop ; Bride ; U Bolt ; Federbride :							
	B020M12A002	B10	12.0	62		150	50	
A020T174AA75	Veerstrop ; Bride ; U Bolt ; Federbride :							
	B020M12A024	B10	12.0	62		180	60	
A020T186ZA76	Veerstrop ; Bride ; U Bolt ; Federbride :							
	B020M16A125	B10	16.0	82		240	55	
	Pen ; Axe ; Pin ; Bolzen :							
	YC020FB5483	in B, C en D						
A020T204ZA76	Pen ; Axe ; Pin ; Bolzen :							
	YC020FB4806	boutset						
	YC020FB5487	boutset+bus						
A020T212ZA76	Veerstrop ; Bride ; U Bolt ; Federbride :							
	B020M16A130	B10	16.0	82		340	75	
	Pen ; Axe ; Pin ; Bolzen :							
	YC020FB5483	in B, C en D						
A020T220ZA76	Pen ; Axe ; Pin ; Bolzen :							
	YC020FB5489	in B en C						



Vorm Dia B(1) B(2) L(1) L(2) HD1 HD2

A020T230ZA75

Pen ; Axe ; Pin ; Bolzen :

YC020C401256	in D
YC020C401257	in C
YC020C401258	in B

A020T232ZA70

Veerstrop ; Bride ; U Bolt ; Federbride :

B020M24B121	B18	24.0	101		410		80	
B020M24B059	B18	24.0	101		435		105	

A020T233ZA75

Pen ; Axe ; Pin ; Bolzen :

YC020FB5482	in B, C en D
-------------	--------------

A020T235ZB75

Veerstrop ; Bride ; U Bolt ; Federbride :

B020M20B029	B08	20.0	92		230		80	
B020M20B050	B08	20.0	92		245		80	
B020M20B027	B08	20.0	92		280		80	
B020M20B072	B08	20.0	92		310		140	
B020M20B015	B08	20.0	92		370		80	
B020M20B026	B08	20.0	92		430		120	
B020M20B074	B08	20.0	92		450		95	

Pen ; Axe ; Pin ; Bolzen :

YC020FB5490	in C en D
YC020FB5491	in B

A020T239ZB75

Veerstrop ; Bride ; U Bolt ; Federbride :

B020M20B050	B08	20.0	92		245		80	
B020M20B027	B08	20.0	92		280		80	
B020M20B009	B08	20.0	92		290		80	
B020M20B072	B08	20.0	92		310		140	
B020M20B052	B08	20.0	92		410		80	

Pen ; Axe ; Pin ; Bolzen :

YC020FB5490	in C en D
YC020FB5491	in B

A020T240ZA70

Veerstrop ; Bride ; U Bolt ; Federbride :

B020M24A011	B16	24.0	91		365		70	
-------------	-----	------	----	--	-----	--	----	--

A020T242ZC76

Veerstrop ; Bride ; U Bolt ; Federbride :

B020M24B087	B08	24.0	102		600		90	
B020M24B089	B08	24.0	102		625		90	

Pen ; Axe ; Pin ; Bolzen :

YC020FB5489	in B en C
-------------	-----------

A020T244ZC76

Pen ; Axe ; Pin ; Bolzen :

YC020FB5487	in B, C en D
-------------	--------------



Vorm Dia B(1) B(2) L(1) L(2) HD1 HD2

A020T250ZB76

Pen ; Axe ; Pin ; Bolzen :

YC020FB5489	in B en C
-------------	-----------

A020T258ZA76

Pen ; Axe ; Pin ; Bolzen :

YC020FB5487	in B, C en D
-------------	--------------

A020T259ZB75

Veerstrop ; Bride ; U Bolt ; Federbride :

B020M18A064	B10	18.0	72		200		55	
B020M18A066	B10	18.0	72		220		55	

Pen ; Axe ; Pin ; Bolzen :

YC020FB5488	in B, C en D
-------------	--------------

A020T260ZB76

Veerstrop ; Bride ; U Bolt ; Federbride :

B020M18B067	B08	18.0	82		370		85	
B020M18B071	B08	18.0	82		390		85	
B020M18B002	B08	18.0	82		400		120	

Pen ; Axe ; Pin ; Bolzen :

YC020FB4806	in B, C en D
YC020FB5487	in B, C en D (+ bus)

A020T260ZC76

Veerstrop ; Bride ; U Bolt ; Federbride :

B020M18B076	B08	18.0	82		430		85	
B020M18B007	B08	18.0	82		460		130	

A020T261ZB75

Veerstrop ; Bride ; U Bolt ; Federbride :

B020M12A002	B10	12.0	62		150		50	
-------------	-----	------	----	--	-----	--	----	--

A020T264ZB75

Veerstrop ; Bride ; U Bolt ; Federbride :

B020M12A024	B10	12.0	62		180		60	
-------------	-----	------	----	--	-----	--	----	--

A020T267ZB75

Pen ; Axe ; Pin ; Bolzen :

YC020FB5488	
-------------	--

A020T267ZC75

Veerstrop ; Bride ; U Bolt ; Federbride :

B020M18A064	B10	18.0	72		200		55	
B020M18A065	B10	18.0	72		210		55	
B020M18A066	B10	18.0	72		220		55	

Pen ; Axe ; Pin ; Bolzen :

YC020FB5488	in B, C en D
-------------	--------------



Vorm Dia B(1) B(2) L(1) L(2) HD1 HD2

A020T270ZC76 *Veerstrop ; Bride ; U Bolt ; Federbride :*

B020M24B067	B08	24.0	102		500		90	
B020M24B083	B08	24.0	102		520		90	
B020M24B046	B08	24.0	102		520		120	
B020M24B055	B08	24.0	102		550		120	
B020M24B086	B08	24.0	102		575		90	
B020M24B033	B08	24.0	102		610		120	

Pen ; Axe ; Pin ; Bolzen :

YC020FB5489	in C
YC020T14151S	in B

A020T276ZA75 *Veerstrop ; Bride ; U Bolt ; Federbride :*

B020M20B038	B08	20.0	81		350		70	
B020M20B063	B08	20.0	81		380		70	

Pen ; Axe ; Pin ; Bolzen :

YC020FB5487	in B, C en D
-------------	--------------

A020T277ZA75 *Veerstrop ; Bride ; U Bolt ; Federbride :*

B020M18B050	B08	18.0	82		225		85	
B020M18B059	B08	18.0	82		300		85	
B020M18B006	B08	18.0	82		360		120	

Pen ; Axe ; Pin ; Bolzen :

YC020FB5488	in B, C en D
-------------	--------------

A020T277ZB75 *Veerstrop ; Bride ; U Bolt ; Federbride :*

B020M18B050	B08	18.0	82		225		85	
B020M18B059	B08	18.0	82		300		85	
B020M18B006	B08	18.0	82		360		120	

Pen ; Axe ; Pin ; Bolzen :

YC020FB5488	in B, C en D
-------------	--------------

A020T280ZA75

Pen ; Axe ; Pin ; Bolzen :

YC020C401256	in D
YC020C401257	in C
YC020C401258	in B

A020T284ZA75

Pen ; Axe ; Pin ; Bolzen :

YC020FB5487	in B, C en D
-------------	--------------

A020T285ZA75 *Veerstrop ; Bride ; U Bolt ; Federbride :*

B020M16A091	B10	16.0	72		130		55	
B020M16A094	B10	16.0	72		170		55	

Pen ; Axe ; Pin ; Bolzen :

YC020FB5482	in B, C en D
-------------	--------------



Vorm Dia B(1) B(2) L(1) L(2) HD1 HD2

A020T305ZA75 *Veerstrop ; Bride ; U Bolt ; Federbride :*

B020M20B027	B08	20.0	92		280		80	
B020M20B072	B08	20.0	92		310		140	

A020T306ZA70 *Veerstrop ; Bride ; U Bolt ; Federbride :*

B020M20B060	B0701	20.0	91		275	330	80	
-------------	-------	------	----	--	-----	-----	----	--

A020T310ZC76 *Veerstrop ; Bride ; U Bolt ; Federbride :*

B020M24B083	B08	24.0	102		520		90	
B020M24B085	B08	24.0	102		550		90	
B020M24B087	B08	24.0	102		600		90	
B020M24B033	B08	24.0	102		610		120	

Pen ; Axe ; Pin ; Bolzen :

YC020FB5489	in C
YC020T14151S	in B

A020T311ZB75 *Veerstrop ; Bride ; U Bolt ; Federbride :*

B020M20B049	B08	20.0	92		219		80	
B020M20B029	B08	20.0	92		230		80	
B020M20B050	B08	20.0	92		245		80	
B020M20B027	B08	20.0	92		280		80	
B020M20B072	B08	20.0	92		310		140	
B020M20B026	B08	20.0	92		430		120	

Pen ; Axe ; Pin ; Bolzen :

YC020FB4838	in B
YC020FB4889	in C
YC020FB5490	in C (+bus)
YC020FB5491	in B (+bus)

A020T312ZA75

Pen ; Axe ; Pin ; Bolzen :

YC020FB5487	in B en C
-------------	-----------

A020T314ZA70 *Veerstrop ; Bride ; U Bolt ; Federbride :*

B020M18A094	B10	18.0	82		330		60	
B020M18A042	B10	18.0	82		350		100	
B020M18A120	B10	18.0	82		380		150	

A020T315ZA75 *Veerstrop ; Bride ; U Bolt ; Federbride :*

B020M12A002	B10	12.0	62		150		50	
-------------	-----	------	----	--	-----	--	----	--

A020T316ZA76 *Veerstrop ; Bride ; U Bolt ; Federbride :*

B020M20B063	B08	20.0	81		380		70	
-------------	-----	------	----	--	-----	--	----	--

Pen ; Axe ; Pin ; Bolzen :

YC020FB4806	ZONDER BUS
YC020FB5487	MET BUS



Vorm Dia B(1) B(2) L(1) L(2) HD1 HD2

A020T316ZB76 *Veerstrop ; Bride ; U Bolt ; Federbride :*

B020M20B063	B08	20.0	81		380		70	
B020M20B011	B08	20.0	81		420		70	
B020M20B012	B08	20.0	81		450		120	

Pen ; Axe ; Pin ; Bolzen :

YC020FB4806	in B, C en D
YC020FB5487	in B, C en D (+ bus)

A020T318ZA70 *Veerstrop ; Bride ; U Bolt ; Federbride :*

B020M24B062	B18	24.0	101		425		100	
B020M24B059	B18	24.0	101		435		105	

A020T320ZB76 *Veerstrop ; Bride ; U Bolt ; Federbride :*

B020M20B011	B08	20.0	81		420		70	
B020M20B069	B08	20.0	81		530		120	
B020M20B078	B17	20.0	82		480		80	

Pen ; Axe ; Pin ; Bolzen :

YC020FB5487	in B, C en D
-------------	--------------

A020T321ZA75 *Veerstrop ; Bride ; U Bolt ; Federbride :*

B020M18B049	B08	18.0	82		220		85	
B020M18B050	B08	18.0	82		225		85	
B020M18B054	B08	18.0	82		250		85	
B020M18B055	B08	18.0	82		260		85	
B020M18B056	B08	18.0	82		270		85	

Pen ; Axe ; Pin ; Bolzen :

YC020FB5488	in B, C en D
-------------	--------------

A020T323ZA75 *Veerstrop ; Bride ; U Bolt ; Federbride :*

B020M20B027	B08	20.0	92		280		80	
B020M20B009	B08	20.0	92		290		80	
B020M20B072	B08	20.0	92		310		140	
B020M20B054	B08	20.0	92		430		80	

Pen ; Axe ; Pin ; Bolzen :

YC020FB4838	in B
YC020FB4889	in C en D
YC020FB5490	in C en D (+bus)
YC020FB5491	in B (+bus)

A020T328ZA70 *Veerstrop ; Bride ; U Bolt ; Federbride :*

B020M24B121	B18	24.0	101		410		80	
B020M24B062	B18	24.0	101		425		100	
B020M24B059	B18	24.0	101		435		105	



Vorm Dia B(1) B(2) L(1) L(2) HD1 HD2

A020T330ZA75 *Veerstrop ; Bride ; U Bolt ; Federbride :*

B020M12B006	B08	12.0	62		110		40	
B020M12B008	B08	12.0	62		160		90	

Pen ; Axe ; Pin ; Bolzen :

YC020C401256	in D
YC020C401257	in C
YC020C401258	in B

A020T333ZA75 *Veerstrop ; Bride ; U Bolt ; Federbride :*

B020M20B050	B08	20.0	92		245		80	
B020M20B027	B08	20.0	92		280		80	
B020M20B072	B08	20.0	92		310		140	
B020M20B033	B08	20.0	92		385		80	
B020M20B052	B08	20.0	92		410		80	

Pen ; Axe ; Pin ; Bolzen :

YC020FB4838	in B
YC020FB4889	in C en D
YC020FB5490	in C en D (+bus)
YC020FB5491	in B (+bus)

A020T334ZA75

Pen ; Axe ; Pin ; Bolzen :

YC020C401256	in D
YC020C401257	in C
YC020C401258	in B

A020T337ZA75 *Veerstrop ; Bride ; U Bolt ; Federbride :*

B020M20B037	B08	20.0	81		330		70	
-------------	-----	------	----	--	-----	--	----	--

Pen ; Axe ; Pin ; Bolzen :

YC020FB5490	in C en D
YC020FB5491	in B

A020T339ZA75

Pen ; Axe ; Pin ; Bolzen :

YC020FB5488	in B, C en D
-------------	--------------

A020T341ZB75

Pen ; Axe ; Pin ; Bolzen :

YC020FB5488	in B, C en D
-------------	--------------

A020T342ZA75

Pen ; Axe ; Pin ; Bolzen :

YC020C401256	in D
YC020C401257	in C
YC020C401258	in B



Vorm Dia B(1) B(2) L(1) L(2) HD1 HD2

A020T344ZA75 *Veerstrop ; Bride ; U Bolt ; Federbride :*

B020M12B006	B08	12.0	62		110		40	
-------------	-----	------	----	--	-----	--	----	--

Pen ; Axe ; Pin ; Bolzen :

YC020C401256	in D
YC020C401257	in C
YC020C401258	in B

A020T345ZA75 *Veerstrop ; Bride ; U Bolt ; Federbride :*

B020M18B049	B08	18.0	82		220		85	
B020M18B054	B08	18.0	82		250		85	
B020M18B055	B08	18.0	82		260		85	
B020M18B059	B08	18.0	82		300		85	
B020M18B006	B08	18.0	82		360		120	

Pen ; Axe ; Pin ; Bolzen :

YC020FB5488	over B, C en D
-------------	----------------

A020T351ZA75 *Veerstrop ; Bride ; U Bolt ; Federbride :*

B020M18B058	B08	18.0	82		290		85	
B020M18B060	B08	18.0	82		310		85	

Pen ; Axe ; Pin ; Bolzen :

YC020FB5488	in B, C en D
-------------	--------------

A020T354ZA70 *Veerstrop ; Bride ; U Bolt ; Federbride :*

B020M24A012	B16	24.0	91		415		90	
B020M24A010	B16	24.0	91		470		120	

A020T356ZA75

Pen ; Axe ; Pin ; Bolzen :

YC020FB5489	in C
YC020T14151S	in B

A020T357ZA75 *Veerstrop ; Bride ; U Bolt ; Federbride :*

B020M18A064	B10	18.0	72		200		55	
B020M18A066	B10	18.0	72		220		55	

A020T358ZA75 *Veerstrop ; Bride ; U Bolt ; Federbride :*

B020M20B063	B08	20.0	81		380		70	
B020M20B012	B08	20.0	81		450		120	
B020M20B076	B17	20.0	82		420		80	

Pen ; Axe ; Pin ; Bolzen :

YC020FB5487	in B, C en D
-------------	--------------

A020T364ZA75 *Veerstrop ; Bride ; U Bolt ; Federbride :*

B020M12A005	B10	12.0	62		200		80	
-------------	-----	------	----	--	-----	--	----	--



Vorm Dia B(1) B(2) L(1) L(2) HD1 HD2

A020T367ZA75 *Veerstrop ; Bride ; U Bolt ; Federbride :*

B020M12A002	B10	12.0	62		150		50	
-------------	-----	------	----	--	-----	--	----	--

A020T375ZA75 *Veerstrop ; Bride ; U Bolt ; Federbride :*

B020M18A064	B10	18.0	72		200		55	
B020M18A066	B10	18.0	72		220		55	

Pen ; Axe ; Pin ; Bolzen :

YC020FB5488	in B, C en D
-------------	--------------

A020T377ZA75 *Pen ; Axe ; Pin ; Bolzen :*

YC020FB5488	in B, C en D
-------------	--------------

A020T379ZA75 *Pen ; Axe ; Pin ; Bolzen :*

YC020FB5488	in B, C en D
-------------	--------------

A020T380ZA70 *Veerstrop ; Bride ; U Bolt ; Federbride :*

B020M24A014	B16	24.0	92		340		90	
-------------	-----	------	----	--	-----	--	----	--

A020T382ZA75 *Veerstrop ; Bride ; U Bolt ; Federbride :*

B020M12A024	B10	12.0	62		180		60	
-------------	-----	------	----	--	-----	--	----	--

A020T386ZA76 *Veerstrop ; Bride ; U Bolt ; Federbride :*

B020M16A125	B10	16.0	82		240		55	
-------------	-----	------	----	--	-----	--	----	--

A020T390ZA70 *Veerstrop ; Bride ; U Bolt ; Federbride :*

B020M24A008	B16	24.0	91		380		90	
-------------	-----	------	----	--	-----	--	----	--

A020T398ZA75 *Pen ; Axe ; Pin ; Bolzen :*

YC020C401256	in D
YC020C401257	in C
YC020C401258	in B

A020T399ZA75 *Veerstrop ; Bride ; U Bolt ; Federbride :*

B020M18A064	B10	18.0	72		200		55	
B020M18A066	B10	18.0	72		220		55	
B020M18A071	B10	18.0	72		265		60	

Pen ; Axe ; Pin ; Bolzen :

YC020FB5488	in B, C en D
-------------	--------------

A020T400ZA76 *Pen ; Axe ; Pin ; Bolzen :*

YC020FB5487	in B, C en D
-------------	--------------



Vorm Dia B(1) B(2) L(1) L(2) HD1 HD2

A020T402ZA75

Pen ; Axe ; Pin ; Bolzen :

YC020FB5489	in C
YC020T14151S	in B

A020T404ZA75

Pen ; Axe ; Pin ; Bolzen :

YC020C401256	in D
YC020C401257	in C
YC020C401258	in B

A020T408ZA75

Veerstrop ; Bride ; U Bolt ; Federbride :

B020M12A024	B10	12.0	62		180		60	
-------------	-----	------	----	--	-----	--	----	--

A020T412ZA76

Veerstrop ; Bride ; U Bolt ; Federbride :

B020M18B071	B08	18.0	82		390		85	
B020M18B002	B08	18.0	82		400		120	
B020M18B007	B08	18.0	82		460		130	

Pen ; Axe ; Pin ; Bolzen :

YC020FB4806	in B, C en D
YC020FB5487	in B, C en D (+bus)

A020T414ZA75

Veerstrop ; Bride ; U Bolt ; Federbride :

B020M16A128	B10	16.0	82		300		75	
-------------	-----	------	----	--	-----	--	----	--

Pen ; Axe ; Pin ; Bolzen :

YC020FB5483	in B, C en D
-------------	--------------

A020T416ZA75

Pen ; Axe ; Pin ; Bolzen :

YC020FB5487	in B, C en D
-------------	--------------

A020T417ZA75

Pen ; Axe ; Pin ; Bolzen :

YC020FB5488	in B, C en D
-------------	--------------

A020T419ZA75

Veerstrop ; Bride ; U Bolt ; Federbride :

B020M20B050	B08	20.0	92		245		80	
B020M20B051	B08	20.0	92		260		80	
B020M20B027	B08	20.0	92		280		80	
B020M20B072	B08	20.0	92		310		140	
B020M20B028	B08	20.0	92		330		80	
B020M20B033	B08	20.0	92		385		80	
B020M20B026	B08	20.0	92		430		120	

Pen ; Axe ; Pin ; Bolzen :

YC020FB5490	in C en D
YC020FB5491	in B



Vorm Dia B(1) B(2) L(1) L(2) HD1 HD2

A020T421ZA75 *Veerstrop ; Bride ; U Bolt ; Federbride :*

B020M20B029	B08	20.0	92		230		80	
B020M20B050	B08	20.0	92		245		80	
B020M20B027	B08	20.0	92		280		80	
B020M20B009	B08	20.0	92		290		80	
B020M20B072	B08	20.0	92		310		140	

Pen ; Axe ; Pin ; Bolzen :

YC020FB5483	in C en D
YC020T14311S	in B

A020T428ZA75 *Veerstrop ; Bride ; U Bolt ; Federbride :*

B020M12A024	B10	12.0	62		180		60	
-------------	-----	------	----	--	-----	--	----	--

A020T430ZA75 *Veerstrop ; Bride ; U Bolt ; Federbride :*

B020M12A024	B10	12.0	62		180		60	
-------------	-----	------	----	--	-----	--	----	--

A020T435ZA75

Pen ; Axe ; Pin ; Bolzen :

YC020C401248	in B, C en D
--------------	--------------

A020T440ZA75 *Veerstrop ; Bride ; U Bolt ; Federbride :*

B020M16A119	B10	16.0	82		180		55	
B020M16A123	B10	16.0	82		220		55	

Pen ; Axe ; Pin ; Bolzen :

YC020FB5483	in B, C en D
-------------	--------------

A020T444ZA75

Pen ; Axe ; Pin ; Bolzen :

YC020C401247	in B en C
YC020C401250	in D

A020T448ZA75 *Veerstrop ; Bride ; U Bolt ; Federbride :*

B020M12A024	B10	12.0	62		180		60	
-------------	-----	------	----	--	-----	--	----	--

A020T450ZA75 *Veerstrop ; Bride ; U Bolt ; Federbride :*

B020M12B003	B08	12.0	62		100		40	
-------------	-----	------	----	--	-----	--	----	--

Pen ; Axe ; Pin ; Bolzen :

YC020C401256	in D
YC020C401257	in C
YC020C401258	in B

A020T452ZA75 *Veerstrop ; Bride ; U Bolt ; Federbride :*

B020M24B023	B08	24.0	102		460		80	
-------------	-----	------	-----	--	-----	--	----	--

Pen ; Axe ; Pin ; Bolzen :

YC020FB5489	in C
YC020T14151S	in B



Vorm Dia B(1) B(2) L(1) L(2) HD1 HD2

A020T455ZA75

Pen ; Axe ; Pin ; Bolzen :

YC020FB5488	in B, C en D
-------------	--------------

A020T457ZA75

Veerstrop ; Bride ; U Bolt ; Federbride :

B020M18B049	B08	18.0	82		220		85	
B020M18B050	B08	18.0	82		225		85	

Pen ; Axe ; Pin ; Bolzen :

YC020FB5488	in B, C en D
-------------	--------------

A020T462ZA75

Veerstrop ; Bride ; U Bolt ; Federbride :

B020M12A024	B10	12.0	62		180		60	
-------------	-----	------	----	--	-----	--	----	--

A020T463ZA75

Pen ; Axe ; Pin ; Bolzen :

YC020FB5488	in B, C en D
-------------	--------------

A020T464ZA76

Pen ; Axe ; Pin ; Bolzen :

YC020FB4806	boutset
YC020FB5487	boutset+bus

A020T466ZA76

Pen ; Axe ; Pin ; Bolzen :

YC020FB4806	boutset
YC020FB5487	boutset+bus

A020T472ZA75

Veerstrop ; Bride ; U Bolt ; Federbride :

B020M12B013	B08	12.0	72		170		45	
B020M12B012	B08	12.0	72		170		80	

Pen ; Axe ; Pin ; Bolzen :

YC020C401247	in B en C
YC020C401250	in D

A020T472ZB75

Veerstrop ; Bride ; U Bolt ; Federbride :

B020M12B011	B08	12.0	72		220		80	
-------------	-----	------	----	--	-----	--	----	--

A020T474ZA75

Veerstrop ; Bride ; U Bolt ; Federbride :

B020M12B006	B08	12.0	62		110		40	
-------------	-----	------	----	--	-----	--	----	--

Pen ; Axe ; Pin ; Bolzen :

YC020C401256	in D
YC020C401257	in C
YC020C401258	in B

A020T475ZA75

Veerstrop ; Bride ; U Bolt ; Federbride :

B020M20B052	B08	20.0	92		410		80	
B020M20B026	B08	20.0	92		430		120	



Vorm Dia B(1) B(2) L(1) L(2) HD1 HD2

A020T476ZA75 *Veerstrop ; Bride ; U Bolt ; Federbride :*

B020M12B006	B08	12.0	62		110		40	
B020M12B008	B08	12.0	62		160		90	

Pen ; Axe ; Pin ; Bolzen :

YC020C401256	in D
YC020C401257	in C
YC020C401258	in B

A020T478ZA76

Pen ; Axe ; Pin ; Bolzen :

YC020FB5487	in B, C en D
-------------	--------------

A020T485ZA75 *Veerstrop ; Bride ; U Bolt ; Federbride :*

B020M20B009	B08	20.0	92		290		80	
B020M20B002	B08	20.0	92		310		80	
B020M20B072	B08	20.0	92		310		140	
B020M20B028	B08	20.0	92		330		80	
B020M20B074	B08	20.0	92		450		95	

Pen ; Axe ; Pin ; Bolzen :

YC020FB5490	in C en D
YC020FB5491	in B

A020T486ZA70 *Veerstrop ; Bride ; U Bolt ; Federbride :*

B020M24B040	B18	24.0	101		445		80	
B020M24B061	B18	24.0	101		485		100	
B020M24B135	B18	24.0	101		510		150	

A020T490ZA75 *Veerstrop ; Bride ; U Bolt ; Federbride :*

B020M12B003	B08	12.0	62		100		40	
-------------	-----	------	----	--	-----	--	----	--

Pen ; Axe ; Pin ; Bolzen :

YC020C401256	in D
YC020C401257	in C
YC020C401258	in B

A020T492ZA75 *Veerstrop ; Bride ; U Bolt ; Federbride :*

B020M12B003	B08	12.0	62		100		40	
-------------	-----	------	----	--	-----	--	----	--

Pen ; Axe ; Pin ; Bolzen :

YC020C401256	in D
YC020C401257	in C
YC020C401258	in B

A020T494ZA75 *Veerstrop ; Bride ; U Bolt ; Federbride :*

B020M12A006	B10	12.0	62		220		80	
-------------	-----	------	----	--	-----	--	----	--



Vorm Dia B(1) B(2) L(1) L(2) HD1 HD2

A020T500ZA75 *Veerstrop ; Bride ; U Bolt ; Federbride :*

B020M12B006	B08	12.0	62		110		40	
-------------	-----	------	----	--	-----	--	----	--

Pen ; Axe ; Pin ; Bolzen :

YC020C401256	in D
YC020C401257	in C
YC020C401258	in B

A020T505ZA75 *Veerstrop ; Bride ; U Bolt ; Federbride :*

B020M12A002	B10	12.0	62		150		50	
-------------	-----	------	----	--	-----	--	----	--

A020T507ZA75 *Veerstrop ; Bride ; U Bolt ; Federbride :*

B020M20B083	B08	20.0	92		535		120	
-------------	-----	------	----	--	-----	--	-----	--

Pen ; Axe ; Pin ; Bolzen :

YC020FB5490	in C en D
YC020FB5491	in B

A020T509ZA75 *Veerstrop ; Bride ; U Bolt ; Federbride :*

B020M20B054	B08	20.0	92		430		80	
-------------	-----	------	----	--	-----	--	----	--

Pen ; Axe ; Pin ; Bolzen :

YC020FB5483	in C en D
YC020T14311S	in B

A020T511ZA75 *Veerstrop ; Bride ; U Bolt ; Federbride :*

B020M18B049	B08	18.0	82		220		85	
B020M18B050	B08	18.0	82		225		85	

Pen ; Axe ; Pin ; Bolzen :

YC020C401240	in B
YC020C401244	in C en D

A020T512ZA75 *Veerstrop ; Bride ; U Bolt ; Federbride :*

B020M12B003	B08	12.0	62		100		40	
B020M12B008	B08	12.0	62		160		90	

Pen ; Axe ; Pin ; Bolzen :

YC020C401256	in D
YC020C401257	in C
YC020C401258	in B

A020T520ZA76

Pen ; Axe ; Pin ; Bolzen :

YC020FB4806	boutset
YC020FB5487	boutset+bus

A020T540ZA76 *Veerstrop ; Bride ; U Bolt ; Federbride :*

B020M20B085	B08	20.0	81		530		80	
B020M20B069	B08	20.0	81		530		120	

Pen ; Axe ; Pin ; Bolzen :

YC020FB5487	in B, C en D
-------------	--------------



Vorm Dia B(1) B(2) L(1) L(2) HD1 HD2

A020T546ZA70 *Veerstrop ; Bride ; U Bolt ; Federbride :*

B020M24B062	B18	24.0	101		425		100	
-------------	-----	------	-----	--	-----	--	-----	--

A020T547ZA75

Pen ; Axe ; Pin ; Bolzen :

YC020FB5488	in B, C en D
-------------	--------------

A020T548ZA76 *Veerstrop ; Bride ; U Bolt ; Federbride :*

B020M24B085	B08	24.0	102		550		90	
-------------	-----	------	-----	--	-----	--	----	--

Pen ; Axe ; Pin ; Bolzen :

YC020FB5489	in C
YC020T14151S	in B

A020T562ZA76

Pen ; Axe ; Pin ; Bolzen :

YC020FB5489	in C
YC020T14151S	in B

A020T563ZA75 *Veerstrop ; Bride ; U Bolt ; Federbride :*

B020M16A119	B10	16.0	82		180		55	
B020M16A121	B10	16.0	82		200		55	
B020M16A123	B10	16.0	82		220		55	

Pen ; Axe ; Pin ; Bolzen :

YC020C401248	in B, C en D
--------------	--------------

A020T573ZA75 *Veerstrop ; Bride ; U Bolt ; Federbride :*

B020M16A119	B10	16.0	82		180		55	
B020M16A123	B10	16.0	82		220		55	

Pen ; Axe ; Pin ; Bolzen :

YC020C401248	in B, C en D
--------------	--------------

A020T575ZA75 *Veerstrop ; Bride ; U Bolt ; Federbride :*

B020M16A123	B10	16.0	82		220		55	
-------------	-----	------	----	--	-----	--	----	--

Pen ; Axe ; Pin ; Bolzen :

YC020C401253	in C en D
YC020C401254	in B

A020T581ZA75 *Veerstrop ; Bride ; U Bolt ; Federbride :*

B020M18A068	B10	18.0	72		230		55	
-------------	-----	------	----	--	-----	--	----	--

Pen ; Axe ; Pin ; Bolzen :

YC020C401243	in C en D
YC020C401244	in B

A020T587ZA75

Pen ; Axe ; Pin ; Bolzen :

YC020FB5488	in B, C en D
-------------	--------------



Vorm Dia B(1) B(2) L(1) L(2) HD1 HD2

A020T589ZA75

Pen ; Axe ; Pin ; Bolzen :

YC020FB5490	in C en D
YC020FB5491	in B

A020T594ZA76

Pen ; Axe ; Pin ; Bolzen :

YC020C401252	in C en D
--------------	-----------

A020T607ZA75

Veerstrop ; Bride ; U Bolt ; Federbride :

B020M20B027	B08	20.0	92		280		80	
B020M20B009	B08	20.0	92		290		80	
B020M20B052	B08	20.0	92		410		80	

Pen ; Axe ; Pin ; Bolzen :

YC020C401228	in B, C en D
YC020C466020	VEERSCHOMMEL

A020T609ZA75

Pen ; Axe ; Pin ; Bolzen :

YC020C401243	in C en D
YC020C401244	in B

A020T615ZA75

Veerstrop ; Bride ; U Bolt ; Federbride :

B020M20B050	B08	20.0	92		245		80	
B020M20B027	B08	20.0	92		280		80	
B020M20B009	B08	20.0	92		290		80	

Pen ; Axe ; Pin ; Bolzen :

YC020C401228	in B, C en D
YC020C466020	VEERSCHOMMEL

A020T623ZA75

Veerstrop ; Bride ; U Bolt ; Federbride :

B020M20B009	B08	20.0	92		290		80	
B020M20B072	B08	20.0	92		310		140	

Pen ; Axe ; Pin ; Bolzen :

YC020C401228	in B, C en D
YC020C466020	VEERSCHOMMEL

A020T639ZA75

Pen ; Axe ; Pin ; Bolzen :

YC020C401253	in C en D
YC020C401255	in B

A020T641ZA75

Pen ; Axe ; Pin ; Bolzen :

YC020C401253	in C en D
YC020C401255	in B

A020T643ZA75

Pen ; Axe ; Pin ; Bolzen :

YC020C401254	in B
YC020C401255	in C en D



Vorm Dia B(1) B(2) L(1) L(2) HD1 HD2

A020T646ZA75 *Veerstrop ; Bride ; U Bolt ; Federbride :*

B020M12B013	B08	12.0	72		170		45	
-------------	-----	------	----	--	-----	--	----	--

A020T651ZA75

Pen ; Axe ; Pin ; Bolzen :

YC020C401240	in B
YC020C401244	in C en D

A020T652ZA76 *Veerstrop ; Bride ; U Bolt ; Federbride :*

B020M20B078	B17	20.0	82		480		80	
B020M20B079	B17	20.0	82		490		150	

Pen ; Axe ; Pin ; Bolzen :

YC020C401240	in B
YC020C401243	in C en D

A020T653ZA75 *Veerstrop ; Bride ; U Bolt ; Federbride :*

B020M20B050	B08	20.0	92		245		80	
B020M20B051	B08	20.0	92		260		80	
B020M20B072	B08	20.0	92		310		140	

Pen ; Axe ; Pin ; Bolzen :

YC020C401228	in B, C en D
YC020C466020	VEERSCHOMMEL

A020T654ZA76 *Veerstrop ; Bride ; U Bolt ; Federbride :*

B020M20B078	B17	20.0	82		480		80	
B020M20B079	B17	20.0	82		490		150	
B020M20B087	B17	20.0	82		520		80	

Pen ; Axe ; Pin ; Bolzen :

YC020C401240	in B
YC020C401243	in C en D

A020T657ZA75

Pen ; Axe ; Pin ; Bolzen :

YC020C401248	in B, C en D
--------------	--------------

A020T677ZA75

Pen ; Axe ; Pin ; Bolzen :

YC020C401240	in B
YC020C401244	in C en D

A020T679ZA75

Pen ; Axe ; Pin ; Bolzen :

YC020FB5491	in B
-------------	------

A020T681ZA75

Pen ; Axe ; Pin ; Bolzen :

YC020FB5491	in B, C en D
-------------	--------------



Vorm Dia B(1) B(2) L(1) L(2) HD1 HD2

A020T683ZA75

Pen ; Axe ; Pin ; Bolzen :

YC020FB5491	in B
-------------	------

A020T684ZA76

Veerstrop ; Bride ; U Bolt ; Federbride :

B020M24B083	B08	24.0
B020M24B087	B08	24.0

102		520		90	
102		600		90	

Pen ; Axe ; Pin ; Bolzen :

YC020C401241	in B
YC020C401245	in C en D

A020T685ZA75

Pen ; Axe ; Pin ; Bolzen :

YC020FB5491	in B, C en D
-------------	--------------

A020T686ZA76

Pen ; Axe ; Pin ; Bolzen :

YC020C401252	in C en D
--------------	-----------

A020T695ZA75

Pen ; Axe ; Pin ; Bolzen :

YC020C401243	in C en D
YC020C401244	in B

A020T702ZA75

Pen ; Axe ; Pin ; Bolzen :

YC020C401252	in C en D
--------------	-----------

A020T706ZA70

Veerstrop ; Bride ; U Bolt ; Federbride :

B020M24B060	B18	24.0
B020M24B135	B18	24.0

101		465		105	
101		510		150	

A020T716ZA75

Pen ; Axe ; Pin ; Bolzen :

YC020C401241	in B
YC020FB5489	in C

A020T720ZA75

Pen ; Axe ; Pin ; Bolzen :

YC020FB5489	in C, links
YC020T14151S	in B
YC020T14181S	in C, rechts

A020T726ZA76

Pen ; Axe ; Pin ; Bolzen :

YC020C401252	in C en D
--------------	-----------



Vorm Dia B(1) B(2) L(1) L(2) HD1 HD2

A020T728ZA76 *Veerstrop ; Bride ; U Bolt ; Federbride :*

B020M24B085	B08	24.0	102		550		90	
-------------	-----	------	-----	--	-----	--	----	--

Pen ; Axe ; Pin ; Bolzen :

YC020C401241	in B
YC020C401245	in C en D

A020T740ZA76 *Veerstrop ; Bride ; U Bolt ; Federbride :*

B020M24B067	B08	24.0	102		500		90	
-------------	-----	------	-----	--	-----	--	----	--

Pen ; Axe ; Pin ; Bolzen :

YC020C401241	in B
YC020C401245	in C en D

A020T742ZA76

Pen ; Axe ; Pin ; Bolzen :

YC020C401241	in B
YC020C401245	in C en D

A020T744ZA76

Pen ; Axe ; Pin ; Bolzen :

YC020C401241	in B
YC020C401245	in C en D

A020T754ZA76

Pen ; Axe ; Pin ; Bolzen :

YC020C401252	in C en D
--------------	-----------

A020T778ZA76

Pen ; Axe ; Pin ; Bolzen :

YC020C401252	in C en D
--------------	-----------

F020T296ZA76 *Veerstrop ; Bride ; U Bolt ; Federbride :*

B020M24B086	B08	24.0	102		575		90	
B020M24B033	B08	24.0	102		610		120	

Pen ; Axe ; Pin ; Bolzen :

YC020FB5489	in C
YC020T14151S	in B

F020T297ZA75 *Veerstrop ; Bride ; U Bolt ; Federbride :*

B020M20B027	B08	20.0	92		280		80	
B020M20B074	B08	20.0	92		450		95	

Pen ; Axe ; Pin ; Bolzen :

YC020FB5490	in C en D
YC020FB5491	in B



Vorm Dia B(1) B(2) L(1) L(2) HD1 HD2

F020T298ZA76 *Veerstrop ; Bride ; U Bolt ; Federbride :*

B020M24B023	B08	24.0	102		460		80	
B020M24B081	B08	24.0	102		475		80	
B020M24B144	B08	24.0	102		485		75	
B020M24B046	B08	24.0	102		520		120	

Pen ; Axe ; Pin ; Bolzen :

YC020FB5489	in C
YC020T14151S	in B

F020T299ZA75 *Veerstrop ; Bride ; U Bolt ; Federbride :*

B020M20B049	B08	20.0	92		219		80	
B020M20B029	B08	20.0	92		230		80	
B020M20B050	B08	20.0	92		245		80	
B020M20B027	B08	20.0	92		280		80	
B020M20B072	B08	20.0	92		310		140	

Pen ; Axe ; Pin ; Bolzen :

YC020FB5490	in C en D
YC020FB5491	in B

F020T301ZA75 *Veerstrop ; Bride ; U Bolt ; Federbride :*

B020M12B008	B08	12.0	62		160		90	
--------------------	-----	------	----	--	-----	--	----	--

Pen ; Axe ; Pin ; Bolzen :

YC020C401256	in C
YC020C401258	in B en D

F020T302ZA76

Pen ; Axe ; Pin ; Bolzen :

YC020FB4806	in B, C en D
YC020FB5487	in B, C en D (+ bus)

F020T303ZA75 *Veerstrop ; Bride ; U Bolt ; Federbride :*

B020M20B049	B08	20.0	92		219		80	
B020M20B029	B08	20.0	92		230		80	
B020M20B050	B08	20.0	92		245		80	
B020M20B027	B08	20.0	92		280		80	
B020M20B072	B08	20.0	92		310		140	

Pen ; Axe ; Pin ; Bolzen :

YC020FB5490	in C en D
YC020FB5491	in B

F020T304ZA70 *Veerstrop ; Bride ; U Bolt ; Federbride :*

B020M24B138	B18	24.0	91		305		65	
-------------	-----	------	----	--	-----	--	----	--

F020T308ZA76

Pen ; Axe ; Pin ; Bolzen :

YC020FB5489	in C
YC020T14151S	in B



Vorm Dia B(1) B(2) L(1) L(2) HD1 HD2

F020T346ZA76 *Veerstrop ; Bride ; U Bolt ; Federbride :*

B020M24B067	B08	24.0	102		500		90	
-------------	-----	------	-----	--	-----	--	----	--

Pen ; Axe ; Pin ; Bolzen :

YC020FB5489	in C
YC020T14151S	in B

F020T363ZA75 *Veerstrop ; Bride ; U Bolt ; Federbride :*

B020M18B050	B08	18.0	82		225		85	
B020M18B052	B08	18.0	82		235		85	
B020M18B053	B08	18.0	82		240		85	
B020M18B059	B08	18.0	82		300		85	
B020M18B006	B08	18.0	82		360		120	

Pen ; Axe ; Pin ; Bolzen :

YC020FB5488	in B, C en D
-------------	--------------

F020T369ZA75 *Veerstrop ; Bride ; U Bolt ; Federbride :*

B020M20B049	B08	20.0	92		219		80	
B020M20B029	B08	20.0	92		230		80	
B020M20B050	B08	20.0	92		245		80	
B020M20B027	B08	20.0	92		280		80	
B020M20B009	B08	20.0	92		290		80	
B020M20B072	B08	20.0	92		310		140	

Pen ; Axe ; Pin ; Bolzen :

YC020FB5490	in C en D
YC020FB5491	in B

F020T370ZA76 *Veerstrop ; Bride ; U Bolt ; Federbride :*

B020M20B038	B08	20.0	81		350		70	
B020M20B063	B08	20.0	81		380		70	

Pen ; Axe ; Pin ; Bolzen :

YC020FB5487	in B, C en D
-------------	--------------

F020T395ZA75

Pen ; Axe ; Pin ; Bolzen :

YC020C401256	in C
YC020C401258	in B en D

F020T403ZA75

Pen ; Axe ; Pin ; Bolzen :

YC020C401247	in C en D
YC020C401249	in B

F020T405ZA75

Pen ; Axe ; Pin ; Bolzen :

YC020FB5488	in B, C en D
-------------	--------------



Vorm Dia B(1) B(2) L(1) L(2) HD1 HD2

F020T415ZA75 *Veerstrop ; Bride ; U Bolt ; Federbride :*

B020M18B054	B08	18.0	82		250		85	
-------------	-----	------	----	--	-----	--	----	--

Pen ; Axe ; Pin ; Bolzen :

YC020FB5488	in B, C en D
-------------	--------------

F020T423ZA75

Pen ; Axe ; Pin ; Bolzen :

YC020FB5488	in B, C en D
-------------	--------------

F020T429ZA75

Pen ; Axe ; Pin ; Bolzen :

YC020C401248	in B, C en D
--------------	--------------

F020T431ZA75

Pen ; Axe ; Pin ; Bolzen :

YC020FB5488	in B, C en D
-------------	--------------

F020T432ZA76 *Veerstrop ; Bride ; U Bolt ; Federbride :*

B020M20B038	B08	20.0	81		350		70	
B020M20B063	B08	20.0	81		380		70	

Pen ; Axe ; Pin ; Bolzen :

YC020FB5487	in B, C en D
-------------	--------------

F020T433ZA75 *Veerstrop ; Bride ; U Bolt ; Federbride :*

B020M18A064	B10	18.0	72		200		55	
B020M18A066	B10	18.0	72		220		55	

Pen ; Axe ; Pin ; Bolzen :

YC020FB5488	in B, C en D
-------------	--------------

F020T439ZA75 *Veerstrop ; Bride ; U Bolt ; Federbride :*

B020M12B008	B08	12.0	62		160		90	
--------------------	-----	------	----	--	-----	--	----	--

Pen ; Axe ; Pin ; Bolzen :

YC020C401256	in C
YC020C401258	in B en D

F020T441ZA75

Pen ; Axe ; Pin ; Bolzen :

YC020FB5488	in B, C en D
-------------	--------------

F020T443AA75

Pen ; Axe ; Pin ; Bolzen :

YC020C401262	in C
--------------	------

F020T443ZA75

Pen ; Axe ; Pin ; Bolzen :

YC020C401262	in C
--------------	------



Vorm Dia B(1) B(2) L(1) L(2) HD1 HD2

F020T445ZA75

Pen ; Axe ; Pin ; Bolzen :

YC020C401248	in B, C en D
--------------	--------------

F020T446ZA75

Pen ; Axe ; Pin ; Bolzen :

YC020C401251	in C en D
--------------	-----------

F020T456ZA76

Veerstrop ; Bride ; U Bolt ; Federbride :

B020M24B084	B08	24.0	102		530		90	
B020M24B085	B08	24.0	102		550		90	
B020M24B055	B08	24.0	102		550		120	
B020M24B033	B08	24.0	102		610		120	

Pen ; Axe ; Pin ; Bolzen :

YC020FB5489	in C
YC020T14151S	in B

F020T458ZA76

Veerstrop ; Bride ; U Bolt ; Federbride :

B020M20B076	B17	20.0	82		420		80	
B020M20B079	B17	20.0	82		490		150	

Pen ; Axe ; Pin ; Bolzen :

YC020FB4806	in B, C en D
YC020FB5487	in B, C en D (+ bus)

F020T459ZA75

Pen ; Axe ; Pin ; Bolzen :

YC020C401253	in C en D
YC020C401255	in B

F020T461ZA75

Pen ; Axe ; Pin ; Bolzen :

YC020C401253	in C en D
YC020C401255	in B

F020T465ZA75

Pen ; Axe ; Pin ; Bolzen :

YC020C401248	in C en D
YC020C401249	in B

F020T467ZA75

Pen ; Axe ; Pin ; Bolzen :

YC020C401248	in C en D
YC020C401249	in B

F020T469ZA75

Pen ; Axe ; Pin ; Bolzen :

YC020C401248	in C en D
YC020C401249	in B



Vorm Dia B(1) B(2) L(1) L(2) HD1 HD2

F020T471ZA75

Pen ; Axe ; Pin ; Bolzen :

YC020C401248	in B, C en D
--------------	--------------

F020T473ZA75

Veerstrop ; Bride ; U Bolt ; Federbride :

B020M16A119	B10	16.0	82		180		55	
B020M16A121	B10	16.0	82		200		55	

Pen ; Axe ; Pin ; Bolzen :

YC020C401248	in B, C en D
--------------	--------------

F020T477ZA75

Veerstrop ; Bride ; U Bolt ; Federbride :

B020M18B055	B08	18.0	82		260		85	
B020M20B049	B08	20.0	92		219		80	
B020M20B050	B08	20.0	92		245		80	
B020M20B027	B08	20.0	92		280		80	
B020M20B072	B08	20.0	92		310		140	

Pen ; Axe ; Pin ; Bolzen :

YC020FB5488	in B, C en D
-------------	--------------

F020T479ZA75

Veerstrop ; Bride ; U Bolt ; Federbride :

B020M20B043	B08	20.0	92		170		55	
B020M20B049	B08	20.0	92		219		80	

Pen ; Axe ; Pin ; Bolzen :

YC020FB5488	in C en D
-------------	-----------

F020T481AA75

Pen ; Axe ; Pin ; Bolzen :

YC020C401262	in C
--------------	------

F020T483ZA75

Pen ; Axe ; Pin ; Bolzen :

YC020C401256	in C
YC020C401258	in B en D

F020T487AA75

Pen ; Axe ; Pin ; Bolzen :

YC020C401262	in C
--------------	------

F020T487ZA75

Pen ; Axe ; Pin ; Bolzen :

YC020C401262	in C
--------------	------

F020T489ZA75

Pen ; Axe ; Pin ; Bolzen :

YC020C401247	in C en D
YC020C401249	in B

F020T491ZA75

Pen ; Axe ; Pin ; Bolzen :

YC020FB5488	in B, C en D
-------------	--------------



Vorm Dia B(1) B(2) L(1) L(2) HD1 HD2

F020T493ZA75

Pen ; Axe ; Pin ; Bolzen :

YC020FB5488	in B, C en D
-------------	--------------

F020T495ZA75

Pen ; Axe ; Pin ; Bolzen :

YC020C401247	in C en D
YC020C401249	in B

F020T496ZA75

Veerstrop ; Bride ; U Bolt ; Federbride :

B020M18A042	B10	18.0	82		350		100	
--------------------	-----	------	----	--	-----	--	-----	--

Pen ; Axe ; Pin ; Bolzen :

YC020C401253	in C en D
--------------	-----------

F020T497ZA75

Veerstrop ; Bride ; U Bolt ; Federbride :

B020M20B059	B0701	20.0	91		240	350	80	
B020M20B050	B08	20.0	92		245		80	
B020M20B072	B08	20.0	92		310		140	

Pen ; Axe ; Pin ; Bolzen :

YC020C401240	in B
YC020C401244	in C en D

F020T498ZA75

Veerstrop ; Bride ; U Bolt ; Federbride :

B020M16A128	B10	16.0	82		300		75	
-------------	-----	------	----	--	-----	--	----	--

Pen ; Axe ; Pin ; Bolzen :

YC020C401252	in C en D
--------------	-----------

F020T499ZA75

Veerstrop ; Bride ; U Bolt ; Federbride :

B020M18B050	B08	18.0	82		225		85	
-------------	-----	------	----	--	-----	--	----	--

Pen ; Axe ; Pin ; Bolzen :

YC020C401240	in B
YC020C401244	in C en D

F020T499ZB75

Pen ; Axe ; Pin ; Bolzen :

YC020C401240	in B
YC020C401244	in C en D

F020T501ZA75

Pen ; Axe ; Pin ; Bolzen :

YC020C401240	in B
YC020C401244	in C en D

F020T503ZA75

Veerstrop ; Bride ; U Bolt ; Federbride :

B020M20B049	B08	20.0	92		219		80	
B020M20B029	B08	20.0	92		230		80	

Pen ; Axe ; Pin ; Bolzen :

YC020FB5490	in C en D
YC020FB5491	in B



Vorm Dia B(1) B(2) L(1) L(2) HD1 HD2

F020T504ZA75

Pen ; Axe ; Pin ; Bolzen :

YC020C401250	in C
--------------	------

F020T508ZA75

Veerstrop ; Bride ; U Bolt ; Federbride :

B020M24B023	B08	24.0	102		460		80	
B152M24B020	B08	24.0	102		475		120	

Pen ; Axe ; Pin ; Bolzen :

YC020FB5489	in C
YC020T14151S	in B

F020T510ZA75

Veerstrop ; Bride ; U Bolt ; Federbride :

B020M16A095	B10	16.0	72		180		55	
-------------	-----	------	----	--	-----	--	----	--

F020T513ZA75

Veerstrop ; Bride ; U Bolt ; Federbride :

B020M18B055	B08	18.0	82		260		85	
-------------	-----	------	----	--	-----	--	----	--

Pen ; Axe ; Pin ; Bolzen :

YC020C401240	in C en D
YC020C401242	in B

F020T515ZA75

Veerstrop ; Bride ; U Bolt ; Federbride :

B020M18B049	B08	18.0	82		220		85	
B020M18B050	B08	18.0	82		225		85	
B020M18B055	B08	18.0	82		260		85	

Pen ; Axe ; Pin ; Bolzen :

YC020C401240	in B
YC020C401244	in C en D

F020T515ZB75

Pen ; Axe ; Pin ; Bolzen :

YC020C401240	in B
YC020C401244	in C en D

F020T516AA75

Pen ; Axe ; Pin ; Bolzen :

YC020C401250	in C
--------------	------

F020T517ZA75

Veerstrop ; Bride ; U Bolt ; Federbride :

B020M20B047	B08	20.0	92		210		80	
B020M20B049	B08	20.0	92		219		80	

Pen ; Axe ; Pin ; Bolzen :

YC020C401240	in B
YC020C401244	in C en D

F020T517ZB75

Pen ; Axe ; Pin ; Bolzen :

YC020C401240	in B
YC020C401244	in C en D



Vorm Dia B(1) B(2) L(1) L(2) HD1 HD2

F020T517ZS75

Pen ; Axe ; Pin ; Bolzen :

YC020C401240	in B
YC020C401244	in C en D

F020T518ZA75

Pen ; Axe ; Pin ; Bolzen :

YC020C401252	in C en D
--------------	-----------

F020T519ZA75

Pen ; Axe ; Pin ; Bolzen :

YC020C401248	in B, C en D
--------------	--------------

F020T521ZA75

Veerstrop ; Bride ; U Bolt ; Federbride :

B020M16A119	B10	16.0
B020M16A123	B10	16.0
B020M16A125	B10	16.0

82		180		55	
82		220		55	
82		240		55	

Pen ; Axe ; Pin ; Bolzen :

YC020C401248	in C en D
YC020C401249	in B

F020T523ZA75

Pen ; Axe ; Pin ; Bolzen :

YC020C401248	in C en D
YC020C401249	in B

F020T524ZA75

Veerstrop ; Bride ; U Bolt ; Federbride :

B020M18A095	B10	18.0
B020M18A042	B10	18.0

82		340		60	
82		350		100	

Pen ; Axe ; Pin ; Bolzen :

YC020C401252	in C en D
--------------	-----------

F020T525ZA75

Veerstrop ; Bride ; U Bolt ; Federbride :

B020M16A119	B10	16.0
B020M16A121	B10	16.0
B020M16A123	B10	16.0
B020M16A125	B10	16.0

82		180		55	
82		200		55	
82		220		55	
82		240		55	

Pen ; Axe ; Pin ; Bolzen :

YC020C401248	in B, C en D
--------------	--------------

F020T526ZA75

Veerstrop ; Bride ; U Bolt ; Federbride :

B020M16A128	B10	16.0
-------------	-----	------

82		300		75	
----	--	-----	--	----	--

Pen ; Axe ; Pin ; Bolzen :

YC020C401252	in C en D
--------------	-----------



Vorm Dia B(1) B(2) L(1) L(2) HD1 HD2

F020T527ZA75 *Veerstrop ; Bride ; U Bolt ; Federbride :*

B020M16A121	B10	16.0	82		200		55	
B020M16A123	B10	16.0	82		220		55	

Pen ; Axe ; Pin ; Bolzen :

YC020C401248	in B, C en D
--------------	--------------

F020T528ZA76

Pen ; Axe ; Pin ; Bolzen :

YC020FB5487	in B, C en D
-------------	--------------

F020T529ZA75

Pen ; Axe ; Pin ; Bolzen :

YC020C401248	in B, C en D
--------------	--------------

F020T530ZA76

Pen ; Axe ; Pin ; Bolzen :

YC020FB5487	in B, C en D
-------------	--------------

F020T531ZA75

Pen ; Axe ; Pin ; Bolzen :

YC020C401248	in B, C en D
--------------	--------------

F020T533ZA75 *Veerstrop ; Bride ; U Bolt ; Federbride :*

B020M16A119	B10	16.0	82		180		55	
B020M16A123	B10	16.0	82		220		55	
B020M16A125	B10	16.0	82		240		55	

Pen ; Axe ; Pin ; Bolzen :

YC020C401247	in C en D
YC020C401249	in B

F020T535ZA75 *Veerstrop ; Bride ; U Bolt ; Federbride :*

B020M16A119	B10	16.0	82		180		55	
B020M16A123	B10	16.0	82		220		55	
B020M16A125	B10	16.0	82		240		55	

Pen ; Axe ; Pin ; Bolzen :

YC020C401247	in C en D
YC020C401249	in B

F020T536ZA70 *Veerstrop ; Bride ; U Bolt ; Federbride :*

B020M24A013	B16	24.0	92		300		105	
-------------	-----	------	----	--	-----	--	-----	--

F020T537ZA75 *Veerstrop ; Bride ; U Bolt ; Federbride :*

B020M16A121	B10	16.0	82		200		55	
-------------	-----	------	----	--	-----	--	----	--

Pen ; Axe ; Pin ; Bolzen :

YC020C401247	in C en D
YC020C401249	in B



Vorm Dia B(1) B(2) L(1) L(2) HD1 HD2

F020T539ZA75 *Veerstop ; Bride ; U Bolt ; Federbride :*

B020M16A119	B10	16.0	82		180		55	
B020M16A123	B10	16.0	82		220		55	
B020M16A125	B10	16.0	82		240		55	

Pen ; Axe ; Pin ; Bolzen :

YC020C401247	in C en D
YC020C401249	in B

F020T541ZA75 *Veerstop ; Bride ; U Bolt ; Federbride :*

B020M16A119	B10	16.0	82		180		55	
B020M16A125	B10	16.0	82		240		55	

Pen ; Axe ; Pin ; Bolzen :

YC020C401247	in C en D
YC020C401249	in B

F020T542AA75

Pen ; Axe ; Pin ; Bolzen :

YC020C401250	in C
--------------	------

F020T542ZA75 *Veerstop ; Bride ; U Bolt ; Federbride :*

B020M16A098	B10	16.0	72		210		55	
-------------	-----	------	----	--	-----	--	----	--

Pen ; Axe ; Pin ; Bolzen :

YC020C401250	in C
--------------	------

F020T543ZA75 *Veerstop ; Bride ; U Bolt ; Federbride :*

B020M16A119	B10	16.0	82		180		55	
B020M16A121	B10	16.0	82		200		55	
B020M16A123	B10	16.0	82		220		55	
B020M16A125	B10	16.0	82		240		55	

Pen ; Axe ; Pin ; Bolzen :

YC020C401253	in C en D
YC020C401255	in B

F020T544ZA75

Pen ; Axe ; Pin ; Bolzen :

YC020C401252	in C en D
--------------	-----------

F020T545ZA75 *Veerstop ; Bride ; U Bolt ; Federbride :*

B088M18A036	B05	18.0	81		340		80	
B020M16A125	B10	16.0	82		240		55	

Pen ; Axe ; Pin ; Bolzen :

YC020C401253	in C en D
YC020C401255	in B

F020T549ZA75

Pen ; Axe ; Pin ; Bolzen :

YC020FB5490	in B en C, links
YC020FB5491	in C, rechts



Vorm Dia B(1) B(2) L(1) L(2) HD1 HD2

F020T550ZA75 *Veerstrop ; Bride ; U Bolt ; Federbride :*

B020M16A129	B10	16.0	82		320		75	
B020M16A141	B10	16.0	82		400		150	

Pen ; Axe ; Pin ; Bolzen :

YC020C401252	in C en D
--------------	-----------

F020T553ZA75 *Veerstrop ; Bride ; U Bolt ; Federbride :*

B020M18B049	B08	18.0	82		220		85	
B020M18B050	B08	18.0	82		225		85	

Pen ; Axe ; Pin ; Bolzen :

YC020FB5488	in B, C en D
-------------	--------------

F020T555ZA75

Pen ; Axe ; Pin ; Bolzen :

YC020FB5488	in C en D
-------------	-----------

F020T556ZA76

Pen ; Axe ; Pin ; Bolzen :

YC020FB5487	in B, C en D
-------------	--------------

F020T558AA75

Pen ; Axe ; Pin ; Bolzen :

YC020C401250	in C
--------------	------

F020T558ZA75

Pen ; Axe ; Pin ; Bolzen :

YC020C401250	in C
--------------	------

F020T564ZA75

Pen ; Axe ; Pin ; Bolzen :

YC020C401250	in C
--------------	------

F020T565AA75

Pen ; Axe ; Pin ; Bolzen :

YC020C401262	in C
--------------	------

F020T565ZA75

Pen ; Axe ; Pin ; Bolzen :

YC020C401262	in C
--------------	------

F020T568ZA76

Pen ; Axe ; Pin ; Bolzen :

YC020FB5487	in B, C en D
-------------	--------------

F020T569ZA75

Pen ; Axe ; Pin ; Bolzen :

YC020C401253	in C en D
YC020C401255	in B



Vorm Dia B(1) B(2) L(1) L(2) HD1 HD2

F020T570ZA76

Pen ; Axe ; Pin ; Bolzen :

YC020C401240	in B
YC020C401243	in C en D

F020T572ZA76

Pen ; Axe ; Pin ; Bolzen :

YC020C401240	in B
YC020C401243	in C en D

F020T572ZB76

Pen ; Axe ; Pin ; Bolzen :

YC020C401240	in B
YC020C401243	in C en D

F020T576ZA75

Veerstrop ; Bride ; U Bolt ; Federbride :

B020M18A095	B10	18.0	82		340		60	
-------------	-----	------	----	--	-----	--	----	--

Pen ; Axe ; Pin ; Bolzen :

YC020C401253	in C en D
--------------	-----------

F020T577AA75

Pen ; Axe ; Pin ; Bolzen :

YC020C401262	in C
--------------	------

F020T577ZA75

Pen ; Axe ; Pin ; Bolzen :

YC020C401262	in C
--------------	------

F020T578ZA75

Veerstrop ; Bride ; U Bolt ; Federbride :

B020M16A128	B10	16.0	82		300		75	
B020M16A130	B10	16.0	82		340		75	

Pen ; Axe ; Pin ; Bolzen :

YC020C401252	in C en D
--------------	-----------

F020T579AA75

Pen ; Axe ; Pin ; Bolzen :

YC020C401262	in C
--------------	------

F020T580ZA75

Veerstrop ; Bride ; U Bolt ; Federbride :

B020M16A102	B10	16.0	72		255		65	
B020M18A095	B10	18.0	82		340		60	
B020M18A042	B10	18.0	82		350		100	

Pen ; Axe ; Pin ; Bolzen :

YC020C401252	in C en D
--------------	-----------



Vorm Dia B(1) B(2) L(1) L(2) HD1 HD2

F020T582ZA75 *Veerstrop ; Bride ; U Bolt ; Federbride :*

B020M18A093	B10	18.0	82		320		60	
B020M18A095	B10	18.0	82		340		60	
B020M18A042	B10	18.0	82		350		100	

Pen ; Axe ; Pin ; Bolzen :

YC020C401253	in C en D
--------------	-----------

F020T583ZA75 *Veerstrop ; Bride ; U Bolt ; Federbride :*

B020M18B049	B08	18.0	82		220		85	
B020M18B050	B08	18.0	82		225		85	

Pen ; Axe ; Pin ; Bolzen :

YC020C401240	in B
YC020C401244	in C en D

F020T584ZA76 *Veerstrop ; Bride ; U Bolt ; Federbride :*

B020M20B086	B17	20.0	82		350		80	
-------------	-----	------	----	--	-----	--	----	--

Pen ; Axe ; Pin ; Bolzen :

YC020C401240	in B
YC020C401243	in C en D

F020T585ZA75 *Veerstrop ; Bride ; U Bolt ; Federbride :*

B020M20B027	B08	20.0	92		280		80	
B020M20B009	B08	20.0	92		290		80	

Pen ; Axe ; Pin ; Bolzen :

YC020C401228	in B, C en D
YC020C466020	VEERSCHOMMEL

F020T586ZA76 *Veerstrop ; Bride ; U Bolt ; Federbride :*

B020M20B076	B17	20.0	82		420		80	
-------------	-----	------	----	--	-----	--	----	--

Pen ; Axe ; Pin ; Bolzen :

YC020C401240	in B
YC020C401243	in C en D

F020T588ZA75 *Veerstrop ; Bride ; U Bolt ; Federbride :*

B020M18A095	B10	18.0	82		340		60	
B020M18A042	B10	18.0	82		350		100	

Pen ; Axe ; Pin ; Bolzen :

YC020C401251	in C en D
--------------	-----------

F020T590ZA70 *Veerstrop ; Bride ; U Bolt ; Federbride :*

B020M24A011	B16	24.0	91		365		70	
B020M24A008	B16	24.0	91		380		90	



Vorm Dia B(1) B(2) L(1) L(2) HD1 HD2

F020T591ZA75 *Veerstrop ; Bride ; U Bolt ; Federbride :*

B020M20B050	B08	20.0	92		245		80	
B020M20B027	B08	20.0	92		280		80	
B020M20B009	B08	20.0	92		290		80	
B020M20B002	B08	20.0	92		310		80	
B020M20B072	B08	20.0	92		310		140	

Pen ; Axe ; Pin ; Bolzen :

YC020C401228	in B, C en D
YC020C466020	VEERSCHOMMEL

F020T591ZB75

Pen ; Axe ; Pin ; Bolzen :

YC020C401228	in B, C en D
YC020C466020	VEERSCHOMMEL

F020T592ZA75 *Veerstrop ; Bride ; U Bolt ; Federbride :*

B020M16A128	B10	16.0	82		300		75	
-------------	-----	------	----	--	-----	--	----	--

F020T593ZA75

Pen ; Axe ; Pin ; Bolzen :

YC020C401256	in C
YC020C401258	in B en D

F020T595ZA75 *Veerstrop ; Bride ; U Bolt ; Federbride :*

B020M20B050	B08	20.0	92		245		80	
B020M20B027	B08	20.0	92		280		80	

Pen ; Axe ; Pin ; Bolzen :

YC020C401228	in B, C en D
YC020C466020	VEERSCHOMMEL

F020T597ZA75

Pen ; Axe ; Pin ; Bolzen :

YC020C401228	in B, C en D
YC020C466020	VEERSCHOMMEL

F020T598ZA70 *Veerstrop ; Bride ; U Bolt ; Federbride :*

B020M24A014	B16	24.0	92		340		90	
-------------	-----	------	----	--	-----	--	----	--

F020T599ZA75 *Veerstrop ; Bride ; U Bolt ; Federbride :*

B020M18B049	B08	18.0	82		220		85	
B020M18B050	B08	18.0	82		225		85	

F020T600ZA75

Pen ; Axe ; Pin ; Bolzen :

YC020C401251	in C en D
--------------	-----------



Vorm Dia B(1) B(2) L(1) L(2) HD1 HD2

F020T601ZA75 *Veerstrop ; Bride ; U Bolt ; Federbride :*

B020M20B027	B08	20.0	92		280		80	
B020M20B009	B08	20.0	92		290		80	
B020M20B002	B08	20.0	92		310		80	
B020M20B072	B08	20.0	92		310		140	

Pen ; Axe ; Pin ; Bolzen :

YC020FB5490	in B en C, links
YC020FB5491	in C, rechts

F020T602ZA75

Pen ; Axe ; Pin ; Bolzen :

YC020C401251	in C en D
--------------	-----------

F020T604ZA75 *Veerstrop ; Bride ; U Bolt ; Federbride :*

B020M16A128	B10	16.0	82		300		75	
-------------	-----	------	----	--	-----	--	----	--

Pen ; Axe ; Pin ; Bolzen :

YC020C401252	in C en D
--------------	-----------

F020T605ZA75 *Veerstrop ; Bride ; U Bolt ; Federbride :*

B020M20B029	B08	20.0	92		230		80	
B020M20B050	B08	20.0	92		245		80	
B020M20B027	B08	20.0	92		280		80	
B020M20B072	B08	20.0	92		310		140	

Pen ; Axe ; Pin ; Bolzen :

YC020P014222	in B
YC020T14311S	in B

F020T606ZA75 *Veerstrop ; Bride ; U Bolt ; Federbride :*

B020M16A128	B10	16.0	82		300		75	
-------------	-----	------	----	--	-----	--	----	--

Pen ; Axe ; Pin ; Bolzen :

YC020C401252	in C en D
--------------	-----------

F020T608ZA75

Pen ; Axe ; Pin ; Bolzen :

YC020C401252	in C en D
--------------	-----------

F020T611ZA75

Pen ; Axe ; Pin ; Bolzen :

YC020FB5490	in C en D
YC020FB5491	in B

F020T612ZA75 *Veerstrop ; Bride ; U Bolt ; Federbride :*

B020M16A128	B10	16.0	82		300		75	
-------------	-----	------	----	--	-----	--	----	--

F020T617ZA75

Pen ; Axe ; Pin ; Bolzen :

YC020FB5490	in B en C
-------------	-----------



	Vorm	Dia	B(1)	B(2)	L(1)	L(2)	HD1	HD2
F020T620ZA75	<i>Veerstrop ; Bride ; U Bolt ; Federbride :</i>							
	B020M18A095	B10	18.0	82		340		60
F020T626ZA76	<i>Veerstrop ; Bride ; U Bolt ; Federbride :</i>							
	B020M24B023	B08	24.0	102		460		80
	<i>Pen ; Axe ; Pin ; Bolzen :</i>							
	YC020FB5489	in C						
	YC020T14151S	in B						
F020T628ZA76	<i>Veerstrop ; Bride ; U Bolt ; Federbride :</i>							
	B020M24B081	B08	24.0	102		475		80
	<i>Pen ; Axe ; Pin ; Bolzen :</i>							
	YC020FB5489	in C						
	YC020T14151S	in B						
F020T630ZA76	<i>Pen ; Axe ; Pin ; Bolzen :</i>							
	YC020FB5489	in C						
	YC020T14151S	in B						
F020T632AA75	<i>Pen ; Axe ; Pin ; Bolzen :</i>							
	YC020C401250	in C						
F020T632ZA75	<i>Veerstrop ; Bride ; U Bolt ; Federbride :</i>							
	B020M16A098	B10	16.0	72		210		55
	<i>Pen ; Axe ; Pin ; Bolzen :</i>							
	YC020C401250	in C						
F020T634ZA76	<i>Veerstrop ; Bride ; U Bolt ; Federbride :</i>							
	B020M20B077	B17	20.0	82		440		80
	B020M20B079	B17	20.0	82		490		150
	<i>Pen ; Axe ; Pin ; Bolzen :</i>							
	YC020C401240	in B						
	YC020C401243	in C en D						
F020T634ZB76	<i>Pen ; Axe ; Pin ; Bolzen :</i>							
	YC020C401240	in B						
	YC020C401243	in C en D						
F020T635ZA75	<i>Pen ; Axe ; Pin ; Bolzen :</i>							
	YC020C401228	in B, C en D						
	YC020C466020	VEERSCHOMMEL						



Vorm Dia B(1) B(2) L(1) L(2) HD1 HD2

F020T636ZA75 *Veerstrop ; Bride ; U Bolt ; Federbride :*

B020M14B001	B08	14.0	72		74		35	
-------------	-----	------	----	--	----	--	----	--

F020T636ZB75 *Veerstrop ; Bride ; U Bolt ; Federbride :*

B020M14B002	B08	14.0	72		95		50	
-------------	-----	------	----	--	----	--	----	--

F020T637ZA75 *Veerstrop ; Bride ; U Bolt ; Federbride :*

B020M20A014	B05	20.0	91		205		50	
B020M20A015	B05	20.0	91		225		55	
B020M20A016	B05	20.0	91		240		55	
B020M20A017	B05	20.0	91		265		65	
B020M22A003	B05	22.0	91		400		55	

Pen ; Axe ; Pin ; Bolzen :

YC020C401237	in C en D
YC020C401239	in B

F020T637ZB75

Pen ; Axe ; Pin ; Bolzen :

YC020C401237	in C en D
YC020C401239	in B

F020T637ZC75

Pen ; Axe ; Pin ; Bolzen :

YC020C401237	in C en D
YC020C401239	in B

F020T638ZA75 *Veerstrop ; Bride ; U Bolt ; Federbride :*

B020M18B108	Z	18.0			370			
-------------	---	------	--	--	-----	--	--	--

Pen ; Axe ; Pin ; Bolzen :

YC020C401253	in C en D
--------------	-----------

F020T640ZA75

Pen ; Axe ; Pin ; Bolzen :

YC020C401253	in C en D
--------------	-----------

F020T642ZA75

Pen ; Axe ; Pin ; Bolzen :

YC020C401252	in C en D
--------------	-----------

F020T645ZA75 *Veerstrop ; Bride ; U Bolt ; Federbride :*

B020M16A119	B10	16.0	82		180		55	
B020M16A125	B10	16.0	82		240		55	

Pen ; Axe ; Pin ; Bolzen :

YC020C401253	in C en D
YC020C401255	in B



Vorm Dia B(1) B(2) L(1) L(2) HD1 HD2

F020T647ZA75 *Veerstrop ; Bride ; U Bolt ; Federbride :*

B020M20A014	B05	20.0	91		205		50	
B020M20A016	B05	20.0	91		240		55	
B020M20A018	B05	20.0	91		285		55	
B020M20A020	B05	20.0	91		350		55	
B020M22A003	B05	22.0	91		400		55	
B020M22A004	B05	22.0	91		410		70	

Pen ; Axe ; Pin ; Bolzen :

YC020C401237	in C en D
YC020C401239	in B

F020T648ZA75 *Veerstrop ; Bride ; U Bolt ; Federbride :*

B020M18A093	B10	18.0	82		320		60	
B020M18A095	B10	18.0	82		340		60	

Pen ; Axe ; Pin ; Bolzen :

YC020C401253	in C en D
--------------	-----------

F020T649ZA75 *Veerstrop ; Bride ; U Bolt ; Federbride :*

B020M20A015	B05	20.0	91		225		55	
B020M20A016	B05	20.0	91		240		55	
B020M20A017	B05	20.0	91		265		65	
B020M20A021	B05	20.0	91		420		55	
B020M22A002	B05	22.0	91		390		65	
B020M22A003	B05	22.0	91		400		55	
B020M22A004	B05	22.0	91		410		70	

Pen ; Axe ; Pin ; Bolzen :

YC020C401237	in C en D
YC020C401239	in B

F020T655ZA75

Pen ; Axe ; Pin ; Bolzen :

YC020C401228	in B, C en D
YC020C466020	VEERSCHOMMEL

F020T656ZA76

Pen ; Axe ; Pin ; Bolzen :

YC020C401240	in B
YC020C401243	in C en D

F020T658ZA76 *Veerstrop ; Bride ; U Bolt ; Federbride :*

B020M20B076	B17	20.0	82		420		80	
-------------	-----	------	----	--	-----	--	----	--

Pen ; Axe ; Pin ; Bolzen :

YC020C401240	in B
YC020C401243	in C en D



Vorm Dia B(1) B(2) L(1) L(2) HD1 HD2

F020T659ZA75 *Veerstrop ; Bride ; U Bolt ; Federbride :*

B020M20A014	B05	20.0	91		205		50	
B020M20A015	B05	20.0	91		225		55	
B020M20A016	B05	20.0	91		240		55	
B020M20A017	B05	20.0	91		265		65	
B020M22A003	B05	22.0	91		400		55	

Pen ; Axe ; Pin ; Bolzen :

YC020C401237	in C en D
YC020C401239	in B

F020T661ZA75

Pen ; Axe ; Pin ; Bolzen :

YC020C401237	in C en D
YC020C401239	in B

F020T662ZA75 *Veerstrop ; Bride ; U Bolt ; Federbride :*

B020M14A010	B16	14.0	75		115		35	
B020M14A011	B16	14.0	75		135		55	

Pen ; Axe ; Pin ; Bolzen :

YC020C401261	in C
YC020C401263	in B en D

F020T662ZB75 *Veerstrop ; Bride ; U Bolt ; Federbride :*

B020M14A007	B16	14.0	75		150		60	
B020M14A008	B16	14.0	75		170		70	

F020T663ZA75 *Veerstrop ; Bride ; U Bolt ; Federbride :*

B020M20A015	B05	20.0	91		225		55	
-------------	-----	------	----	--	-----	--	----	--

Pen ; Axe ; Pin ; Bolzen :

YC020C401237	in C en D
YC020C401239	in B

F020T665ZA75

Pen ; Axe ; Pin ; Bolzen :

YC020C401237	in C en D
YC020C401239	in B

F020T667ZA75 *Veerstrop ; Bride ; U Bolt ; Federbride :*

B020M20A014	B05	20.0	91		205		50	
-------------	-----	------	----	--	-----	--	----	--

Pen ; Axe ; Pin ; Bolzen :

YC020C401237	in C en D
YC020C401239	in B

F020T668ZA70 *Veerstrop ; Bride ; U Bolt ; Federbride :*

B020M24B140	B18	24.0	91		350		85	
-------------	-----	------	----	--	-----	--	----	--



Vorm Dia B(1) B(2) L(1) L(2) HD1 HD2

F020T669ZA75

Pen ; Axe ; Pin ; Bolzen :

YC020C401237	in C en D
YC020C401239	in B

F020T670AA75

Pen ; Axe ; Pin ; Bolzen :

YC020C401250	in C
--------------	------

F020T670ZA75

Pen ; Axe ; Pin ; Bolzen :

YC020C401250	in C
--------------	------

F020T671ZA75

Pen ; Axe ; Pin ; Bolzen :

YC020C401237	in C en D
YC020C401239	in B

F020T672AA75

Pen ; Axe ; Pin ; Bolzen :

YC020C401250	in C
--------------	------

F020T673ZA75

Veerstrop ; Bride ; U Bolt ; Federbride :

B020M20A015	B05	20.0
B020M20A016	B05	20.0
B020M20A017	B05	20.0
B020M22A003	B05	22.0
B020M22A004	B05	22.0
B020M20A005	B10	20.0

91		225		55	
91		240		55	
91		265		65	
91		400		55	
91		410		70	
92		300		70	

Pen ; Axe ; Pin ; Bolzen :

YC020C401237	in C en D (M24X150)
YC020C401238	in C en D (M24X140)
YC020C401239	in B

F020T673ZB75

Pen ; Axe ; Pin ; Bolzen :

YC020C401237	in C en D (M24X150)
YC020C401238	in C en D (M24X140)
YC020C401239	in B

F020T674ZA75

Pen ; Axe ; Pin ; Bolzen :

YC020C401261	in C
YC020C401262	in B
YC020C401263	in D



Vorm Dia B(1) B(2) L(1) L(2) HD1 HD2

F020T675ZA75 *Veerstrop ; Bride ; U Bolt ; Federbride :*

B020M20A014	B05	20.0	91		205		50	
B020M20A018	B05	20.0	91		285		55	
B020M20A019	B05	20.0	91		315		55	
B020M20A020	B05	20.0	91		350		55	

Pen ; Axe ; Pin ; Bolzen :

YC020C401237	in C en D (M24X150)
YC020C401238	in C en D (M24X140)
YC020C401239	in B

F020T675ZB75

Pen ; Axe ; Pin ; Bolzen :

YC020C401237	in C en D (M24X150)
YC020C401238	in C en D (M24X140)
YC020C401239	in B

F020T676ZA75

Pen ; Axe ; Pin ; Bolzen :

YC020C401240	in B, C en D
--------------	--------------

F020T678ZA76 *Veerstrop ; Bride ; U Bolt ; Federbride :*

B020M24B081	B08	24.0	102		475		80	
B020M24B144	B08	24.0	102		485		75	
B020M24B046	B08	24.0	102		520		120	

Pen ; Axe ; Pin ; Bolzen :

YC020C401241	in B
YC020C401245	in C en D

F020T680ZA75

Pen ; Axe ; Pin ; Bolzen :

YC020C401260	in B, C en D
--------------	--------------

F020T682ZA76

Pen ; Axe ; Pin ; Bolzen :

YC020C401241	in B
YC020C401245	in C en D

F020T687ZA75

Pen ; Axe ; Pin ; Bolzen :

YC020FB5490	in C en D
YC020FB5491	in B

F020T688AA75

Pen ; Axe ; Pin ; Bolzen :

YC020C401250	in C
--------------	------

F020T688ZA75

Pen ; Axe ; Pin ; Bolzen :

YC020C401250	in C
--------------	------



Vorm Dia B(1) B(2) L(1) L(2) HD1 HD2

F020T689ZA75

Pen ; Axe ; Pin ; Bolzen :

YC020FB5483	in C en D
YC020T14311S	in B

F020T690ZA76

Veerstrop ; Bride ; U Bolt ; Federbride :

B020M24B067	B08	24.0	102		500		90	
-------------	-----	------	-----	--	-----	--	----	--

Pen ; Axe ; Pin ; Bolzen :

YC020FB5489	in C
YC020T14151S	in B

F020T691ZA75

Pen ; Axe ; Pin ; Bolzen :

YC020C401237	in C en D (M24X150)
YC020C401238	in C en D (M24X140)
YC020C401239	in B

F020T693ZA75

Pen ; Axe ; Pin ; Bolzen :

YC020C401237	in C en D (M24X150)
YC020C401238	in C en D (M24X140)
YC020C401239	in B

F020T696ZA70

Veerstrop ; Bride ; U Bolt ; Federbride :

B020M24B138	B18	24.0	91		305		65	
-------------	-----	------	----	--	-----	--	----	--

F020T697ZA75

Pen ; Axe ; Pin ; Bolzen :

YC020C401248	in C en D
YC020C401249	in B

F020T698ZA75

Pen ; Axe ; Pin ; Bolzen :

YC020C401261	in C
YC020C401263	in B en D

F020T699ZA75

Pen ; Axe ; Pin ; Bolzen :

YC020C401248	in C en D
YC020C401249	in B

F020T704ZA75

Pen ; Axe ; Pin ; Bolzen :

YC020C401261	in C
YC020C401263	in B en D

F020T709ZA75

Veerstrop ; Bride ; U Bolt ; Federbride :

B020M20A016	B05	20.0	91		240		55	
-------------	-----	------	----	--	-----	--	----	--



Vorm Dia B(1) B(2) L(1) L(2) HD1 HD2

F020T711ZA75 *Veerstrop ; Bride ; U Bolt ; Federbride :*

B020M20A022	B05	20.0	91		265		120	
--------------------	-----	------	----	--	-----	--	-----	--

F020T712ZA75 *Pen ; Axe ; Pin ; Bolzen :*

YC020C401253	in C en D
--------------	-----------

F020T714ZA75 *Pen ; Axe ; Pin ; Bolzen :*

YC020C401253	in C en D
--------------	-----------

F020T718ZA75 *Pen ; Axe ; Pin ; Bolzen :*

YC020C401260	in B, C en D
--------------	--------------

F020T724ZA76 *Veerstrop ; Bride ; U Bolt ; Federbride :*

B020M24B085	B08	24.0	102		550		90	
-------------	-----	------	-----	--	-----	--	----	--

Pen ; Axe ; Pin ; Bolzen :

YC020C401241	in B
YC020C401245	in C en D

F020T730ZA75 *Pen ; Axe ; Pin ; Bolzen :*

YC020C401238	in C en D
YC020C401239	in B

F020T730ZB75 *Pen ; Axe ; Pin ; Bolzen :*

YC020C401238	in C
YC020C401239	in B

F020T732ZA75 *Pen ; Axe ; Pin ; Bolzen :*

YC020C401261	in C
YC020C401263	in B en D

F020T734ZA75 *Pen ; Axe ; Pin ; Bolzen :*

YC020C401261	in C
YC020C401263	in B en D

F020T736ZA75 *Pen ; Axe ; Pin ; Bolzen :*

YC020C401261	in C
YC020C401263	in B en D

F020T738ZA75 *Pen ; Axe ; Pin ; Bolzen :*

YC020C401260	in B, C en D
--------------	--------------



Vorm Dia B(1) B(2) L(1) L(2) HD1 HD2

F020T746ZA76 *Veerstrop ; Bride ; U Bolt ; Federbride :*

B020M24B144	B08	24.0	102		485		75	
-------------	-----	------	-----	--	-----	--	----	--

Pen ; Axe ; Pin ; Bolzen :

YC020C401241	in B
YC020C401245	in C en D

F020T748ZA76

Pen ; Axe ; Pin ; Bolzen :

YC020C401241	in B
YC020C401245	in C en D

F020T750ZA76

Pen ; Axe ; Pin ; Bolzen :

YC020C401241	in B
YC020C401245	in C en D

F020T752ZA76

Pen ; Axe ; Pin ; Bolzen :

YC020C401241	in B
YC020C401245	in C en D

F020T756AA75

Pen ; Axe ; Pin ; Bolzen :

YC020C401250	in C
--------------	------

F020T760ZA75

Pen ; Axe ; Pin ; Bolzen :

YC020C401238	in C en D
YC020C401239	in B

F020T762ZA75 *Veerstrop ; Bride ; U Bolt ; Federbride :*

B152M24B020	B08	24.0	102		475		120	
--------------------	-----	------	-----	--	-----	--	-----	--

Pen ; Axe ; Pin ; Bolzen :

YC020C401238	in C en D
YC020C401239	in B

F020T764ZA75

Pen ; Axe ; Pin ; Bolzen :

YC020C401238	in C en D
YC020C401239	in B

F020T766ZA75

Pen ; Axe ; Pin ; Bolzen :

YC020C401238	in C en D
YC020C401239	in B

F020T768ZA75

Pen ; Axe ; Pin ; Bolzen :

YC020C401238	in C en D
YC020C401239	in B



	Vorm	Dia	B(1)	B(2)	L(1)	L(2)	HD1	HD2
F020T774ZA70	<i>Veerstrop ; Bride ; U Bolt ; Federbride :</i>							
	B020M27B002	B18	27.0	102		415		75
F020T776ZA70	<i>Veerstrop ; Bride ; U Bolt ; Federbride :</i>							
	B020M27B001	B18	27.0	102		383		75
F020T780ZA75	<i>Pen ; Axe ; Pin ; Bolzen :</i>							
	YC020C401253	in C en D						
F020T786AA75	<i>Pen ; Axe ; Pin ; Bolzen :</i>							
	YC020C401250	in C						
F020T786ZA75	<i>Pen ; Axe ; Pin ; Bolzen :</i>							
	YC020C401250	in C						
F020T794ZA70	<i>Veerstrop ; Bride ; U Bolt ; Federbride :</i>							
	B020M27B002	B18	27.0	102		415		75
F020T796ZA70	<i>Veerstrop ; Bride ; U Bolt ; Federbride :</i>							
	B020M27B003	B18	27.0	102		450		75
F020T798ZA75	<i>Veerstrop ; Bride ; U Bolt ; Federbride :</i>							
	B020M16A128	B10	16.0	82		300		75
	<i>Pen ; Axe ; Pin ; Bolzen :</i>							
	YC020C401250	in C en D						
F020T800ZA76	<i>Pen ; Axe ; Pin ; Bolzen :</i>							
	YC020C401240	in B						
	YC020C401243	in C en D						
F020T804ZA70	<i>Veerstrop ; Bride ; U Bolt ; Federbride :</i>							
	B020M24A015	B16	24.0	92		280		90
	B020M24A013	B16	24.0	92		300		105
F020T820ZA75	<i>Veerstrop ; Bride ; U Bolt ; Federbride :</i>							



Vorm Dia B(1) B(2) L(1) L(2) HD1 HD2

F020T834ZA75 *Veerstrop ; Bride ; U Bolt ; Federbride :*

B152M24B020	B08	24.0	102		475		120	
--------------------	-----	------	-----	--	-----	--	-----	--

Pen ; Axe ; Pin ; Bolzen :

YC020C401241	info:EDK (in B)
YC020FB5489	info:EDK (in C)

F020T848ZA75 *Veerstrop ; Bride ; U Bolt ; Federbride :*

B020M18B108	Z	18.0			370			
-------------	---	------	--	--	-----	--	--	--

F020T896ZA75 *Veerstrop ; Bride ; U Bolt ; Federbride :*

B020M16A157	B16	16.0	76		285		55	
-------------	-----	------	----	--	-----	--	----	--

F020T920ZA75 *Veerstrop ; Bride ; U Bolt ; Federbride :*

B020M16A157	B16	16.0	76		285		55	
-------------	-----	------	----	--	-----	--	----	--